

**QST**

*December, 1939*

*25 cents*

devoted entirely to

# amateur radio

# AUTOTUNE is the quick frequency change device used on Collins Transmitters

It has these outstanding advantages:

1. Drastic reduction of space and weight requirements.
2. The same basic Autotune units can be used on transmitters of any power.
3. The Autotune system used as a common design basis greatly reduces construction costs. No expensive time is wasted scheming up different custom-built frequency change gadgets for each application.

4. Autotune costs less than any other frequency change system because it is manufactured in quantity.

5. Autotune is the most highly developed and thoroughly engineered frequency shift arrangement. It has proved itself by flying millions of miles in transports and by working thousands of hours in ground stations of major airlines.

Collins Autotune means lower price, greatest reliability and best performance.

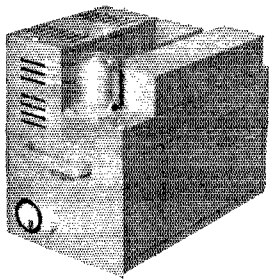
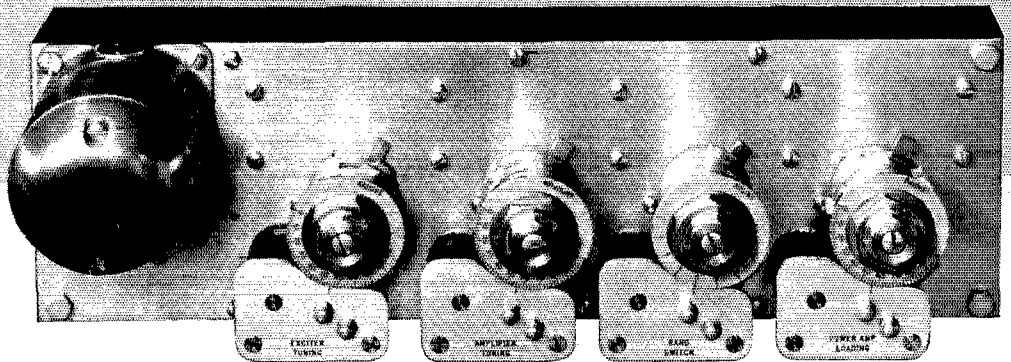

17F-5 (AIRCRAFT) 100 WATTS

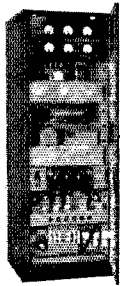

127E 500 WATTS

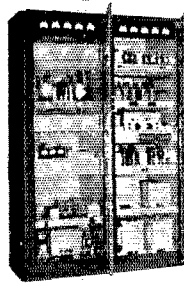

231C 1000 WATTS

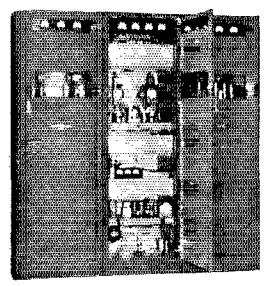

1000A 3000 WATTS

# COLLINS RADIO COMPANY

CEDAR RAPIDS, IOWA

NEW YORK, N.Y.: 11 WEST 42 STREET

# A BETTER SKY CHAMPION THAN EVER BEFORE!

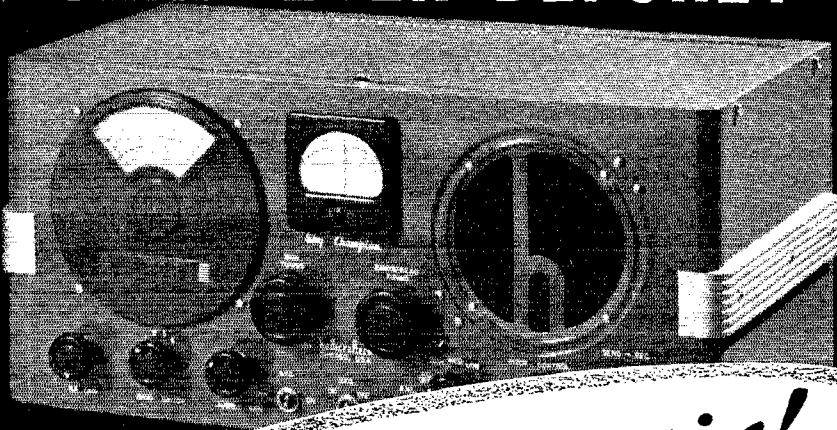

*At no increase in price!*

Though the price of raw materials has advanced in recent months, Hallicrafters manufacturing technique has more than kept pace. Consequently, it was possible either to reduce the price of the Sky Champion or to bring out a greatly improved model at the old price of \$49.50.

Mr. Halligan decided that it would be in keeping with the Hallicrafters policy to produce the finest communications receiver possible to sell just below \$50.00. It is the new S20R Sky Champion.

It has all the fine features of the former model plus these quality additions: 1 Additional Stage of I.F. (2 I.F. Stages in all); 1 Additional Tube (making 9 tubes in all); Dickert Automatic Noise Limiter; Separate Electrical Band Spread—Inertia Controlled; Drift-Compensated High Frequency Oscillator; 3 Watts output; Both Dials Illuminated.

Of course it retains all the essential features of the former model such as a Stage of Pre-Selection; Sponge Mounted Speaker; Beat Frequency Oscillator; Continuous Coverage from 545 kc to 44 mc, etc.

Your purchases of Hallicrafter equipment in such enormous quantities has made this great receiver value possible. It is in the nature of a dividend from the largest builders of amateur communications equipment.

the hallicrafters inc.  
CHICAGO, U. S. A.

"LARGEST BUILDERS OF AMATEUR COMMUNICATIONS EQUIPMENT"



# HT-8 RADIOPHONE

**M**ODEL HT-8 is an efficient 25 watt radiophone (transmitter and communications receiver) designed to occupy a minimum of space—when mounted on a wall.

The transmitter covers five marine frequencies (crystal controlled) selected by a switch on front of cabinet. The five may all be in the 2000-3000 kc range or three may be 2000-3000 and two in the 3000-6000 kc range.

Operation is by the press-to-talk system. When the telephone handset is lifted from the hook on the front panel, the receiver output automatically transfers from the built-in loudspeaker to the handset. To transmit, the operator presses a button on the handset and speaks into the microphone.

The receiver covers six frequencies selected by a switch on the front panel. Four are in the 2000-3000 kc range. The other two may be in either 2000-3000 or 3000-6000 range.

Receiver tuning is adjustable over a narrow range for each frequency by the use of permeability tuned coils. A special oscillator circuit, with temperature and voltage stabilization, gives a highly stable frequency setting.

A QAVC circuit prevents static and noise from appearing in the loudspeaker output when no carrier is present.

Power supply for both transmitter and receiver is a small separate unit with interconnecting cable. Is available for either 12V, 32V or 110V DC. Any of these units is capable of 110V AC operation as well.

All metal parts are either heavily plated or covered with a wrinkle finish over a rust-proof treatment. Transformers are of special nonhydroscopic marine construction. Dimensions of the cabinet are 15 inches wide, 10 inches deep, 18 inches high.

The HT-8, being a mobile unit and easy to operate, has innumerable uses other than marine.

the hallicrafters inc.  
CHICAGO, U. S. A.

**"LARGEST BUILDERS OF AMATEUR COMMUNICATIONS EQUIPMENT"**



DECEMBER 1939

VOLUME XXIII

NUMBER 12



STAFF

Editorial

KENNETH B. WARNER, W1EH  
Editor and Business Manager

CLARK C. RODIMON, W1SX  
Managing Editor

GEORGE GRAMMER, W1DF  
Technical Editor

DONALD H. MIX, W1TS  
BYRON GOODMAN, W1JPE  
Assistant Technical Editors

VERNON CHAMBERS, W1EQ  
Technical Information Service

JAMES J. LAMB, W1AL  
Consultant

Advertising

F. CHEYNEY BEEKLEY, W1OS  
Advertising Manager

CHARLES BRUNELLE  
Asst. Advertising Manager

Circulation

DAVID H. HOUGHTON  
Circulation Manager

RALPH T. BEAUDIN, W1BAW  
Asst. Circulation Manager



OFFICES

38 La Salle Road  
West Hartford, Connecticut

Subscription rate in United States and Possessions and Canada, \$2.50 per year, postpaid; all other countries, \$3.00 per year, postpaid. Single copies, 25 cents. Foreign remittances should be by international postal or express money order or bank draft negotiable in the U. S. and for an equivalent amount in U. S. funds.

Entered as second-class matter May 29, 1919, at the post office at Hartford, Connecticut, under the Act of March 3, 1879. Acceptance for mailing at special rate of postage provided for in section 1103, Act of October 3, 1917, authorized September 9, 1922. Additional entry at Concord, N. H., authorized February 21, 1929, under the Act of February 28, 1925. Additional second-class entries to cover sectional editions authorized March 20, 1935.

Copyright 1939 by the American Radio Relay League, Inc. Title registered at United States Patent Office.

# QST

devoted entirely to

# AMATEUR RADIO

PUBLISHED, MONTHLY, AS ITS OFFICIAL ORGAN, BY THE AMERICAN RADIO RELAY LEAGUE, INC., AT WEST HARTFORD, CONN., U. S. A.; OFFICIAL ORGAN OF THE INTERNATIONAL AMATEUR RADIO UNION



## CONTENTS

Editorials . . . . .	9
Splatter . . . . .	10
Byrd Antarctic Expedition to Use Amateur Radio <i>Clinton B. DeSoto, W1CBD</i>	11
A Four-Tube Superheterodyne . . . <i>Byron Goodman, W1JPE</i>	16
A Homemade Exponential Horn. <i>E. E. Coombs, Jr., ex W6CTN</i>	20
Modern Radio Course Resumed . . . . .	23
What the League Is Doing . . . . .	24
WWV Schedules . . . . .	25
Silent Keys . . . . .	25
"Dish-Type" Construction for the High-Power Amplifier <i>Don H. Mix, W1TS</i>	26
On the Ultra Highs . . . . . <i>E. P. Tillon, W1HDQ</i>	29
The "Portable Five". . . . . <i>Fred Sutter, W8QBW</i>	32
A.R.R.L. Copying Bee — December 8th . . . . .	34
1939 Field Day Tops Them All . . . . . <i>E. L. Battey, W1UE</i>	35
Five Bands Without Changing Coils. <i>T. M. Ferrill, Jr., W1LJI</i>	43
Revamping the 30FXB for 28 and 56 Mc. <i>Llewellyn Bates Keim, W2IKV</i>	46
Hints and Kinks <i>An Efficient and Easily-Made Feeder Spreader — Matching System for Low-Impedance Radiators — Simple Phone Monitoring System — Compact Multiple Crystal Holder — Self-Biasing System for Class-B Modulators . . . . .</i>	49
More on Cathode Modulation. . . . . <i>Frank Edmonds, W2DIY</i>	52
Correspondence from Members . . . . .	55
Naval Communication Reserve Notes . . . . .	56
I.A.R.U. News . . . . .	58
Operating News . . . . .	60
Brass Pounders' League . . . . .	62
How's DX? . . . . .	64
DX Century Club . . . . .	70
Station Activities . . . . .	96
A.R.R.L. QSL Bureau . . . . .	98
Circulation Statement . . . . .	98
Safety ABC's . . . . .	118
Hamads . . . . .	119
QST's Index of Advertisers . . . . .	122
QST Yearly Index . . . . .	125

*For the*

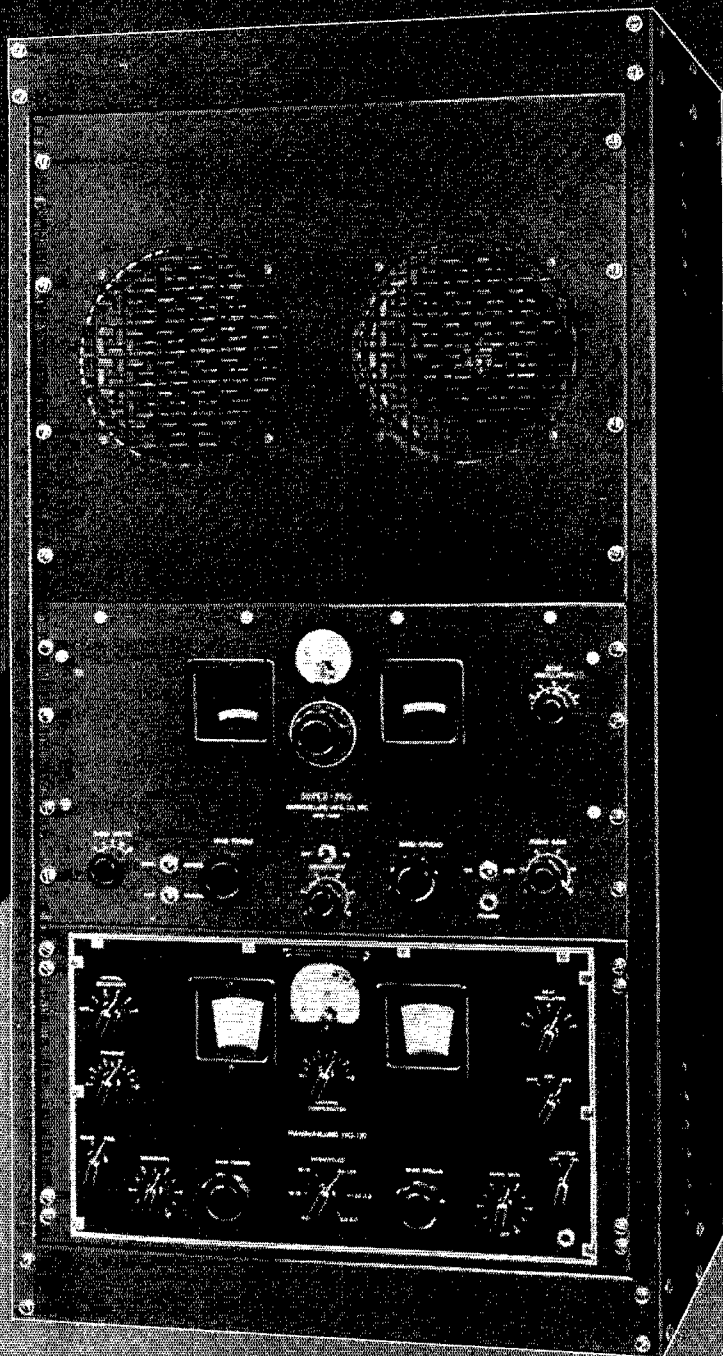

**H**AMMARLUND receiving equipment was selected for the "Byrd" Expedition to "Little America" because it is "tops" in both electrical and mechanical engineering. Both "Super-Pro" and "HQ-120-X" receivers will provide communication with the outside world and will be established in base and outpost stations for continuous service. There are nine "Super-Pro" and six "HQ-120-X" receivers, to be exact, and each will be called upon to perform under very trying conditions. Hammarlund receivers were specified for this historic expedition because of their wide reputation for dependability. Hammarlund receivers have been repeatedly selected by experts for expeditions as well as for commercial and military service because they have that extra quality so necessary for complete satisfaction. You too can now enjoy that extra quality performance. Ask your dealer to demonstrate the new Hammarlund receivers or write to factory for complete technical information.

HAMMARLUND MFG. CO.,  
INC.

424 West 33 St., New York City



**H A M M A R L U N D**

# "Byrd" Expedition!!

## Super Pro

### and HQ-120-X

#### RECEIVERS . . .

**"SUPER-PRO"** has become the standard for comparison among leading engineers and amateurs throughout the entire world. Now, the new Series 200 "Super-Pro" is even better than ever. The flexibility of the new "Super-Pro" is truly amazing. No longer need an operator confine his activities to conditions which fit receiver characteristics. The full range variable selectivity available in the "Super-Pro" allows the operator to adjust the receiver to suit conditions. Perfect control of selectivity from less than 100 cycles to approximately 16 kc. is accomplished by convenient panel controls. Two R.F. stages; noise limiter; adjustable "S" meter; full band spread; high power, high fidelity audio amplifier; variable crystal filter, are just a few of its many outstanding features. Illustrations are actual photographs of part of "Byrd" receiving equipment taken prior to sailing. Write for complete details of new "Super Pro."

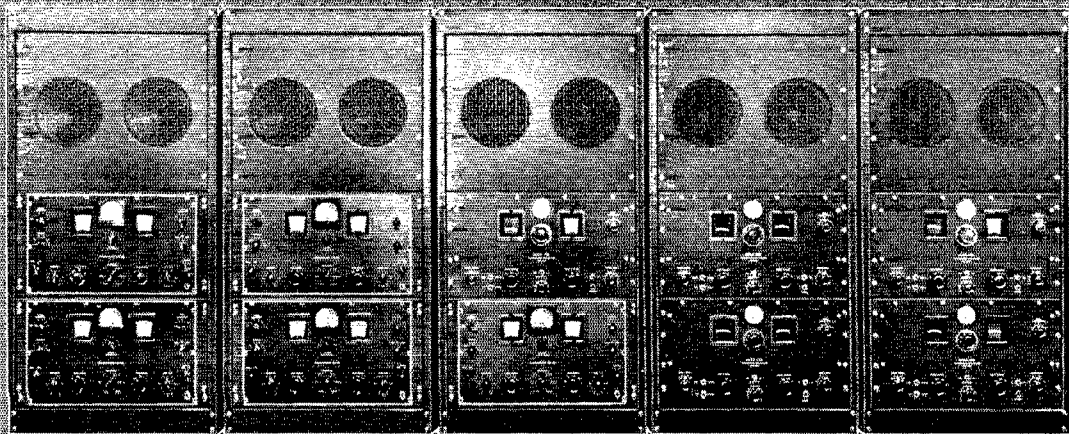

## Section Communications Managers of the A.R.R.L. Communications Department

All appointments in the League's field organization are made by the proper S.C.M., elected by members in each Section listed. Mail your S.C.M. (on the 16th of each month) a postal covering your radio activities for the previous 30 days. Tell him your DX, plans for experimenting, results in 'phone and traffic. He is interested, whether you are an A.R.R.L. member or get your QST at the newsstands; he wants a report from every active ham. If interested and qualified for O.R.S., O.P.S. or other appointments he can tell you about them, too.

<b>ATLANTIC DIVISION</b>			
Eastern Pennsylvania	W3BES	Jerry Mathis	5132 Haverford Ave. Philadelphia
Maryland-Delaware-District of Columbia	W3CIZ	Hermann E. Hobbs	9701 Monroe St. Silver Spring P.O. Linden, Maryland
Southern New Jersey	W3CCO	Lester H. Allen	704 Quinton Ave. Trenton
Western New York	W8CSE	Ed Preston	10 Lincoln Ave. Tully
Western Pennsylvania	W8OFO	Kendall Speer, Jr.	Lowber
<b>CENTRAL DIVISION</b>			
Illinois	W9RMM	Leslie M. Dickson	Edellyn Farms Waukegan
Indiana	W9QG	Noble Burkhart	R. 4, Box 1 Indianapolis
Kentucky	W9ARU	Darrell A. Downard	116 N. Longworth Ave. Louisville
Michigan	W8DPE	Harold C. Bird	R. F. D. 2 Pontiac
Ohio	W8AQ	E. H. Gibbs	405 Broad St. Wadsworth
Wisconsin	W9UTT	Aldrich C. Krones	3127-A West Madison St. Milwaukee
<b>DAKOTA DIVISION</b>			
North Dakota	W9WWL	Anton C. Theodos	c/o American Cafe Minot
South Dakota	W9VOD	Dr. A. L. Russell	Philp Kensington
Northern Minnesota	W9IGZ	Edwin L. Wicklund	R.F.D. 3 Spring Valley
Southern Minnesota	W9VNQ	Millard L. Bender	
<b>DELTA DIVISION</b>			
Arkansas	W5AB1	H. E. Velte	4415 West 12th St. Little Rock
Louisiana *	W5DWW	W. J. Wilkinson, Jr.	1523 Laurel St. Shreveport
Mississippi	W5EWD	Jewell W. Cole	c/o City of McComb Water Dept. McComb City
Tennessee	W4DWS	William Harold Walker	2503 Belmont Blvd. Nashville
<b>HUDSON DIVISION</b>			
Eastern New York	W2LU	Robert E. Haight	511 South Holmes St. Scotia
N. Y. C. & Long Island	W2AZV	E. L. Baunach	102 Central Ave. Massapequa, L. I.
Northern New Jersey	W2GVZ	Joseph P. Jessup	131 California St. Ridgewood
<b>MIDWEST DIVISION</b>			
Iowa	W9PIR	L. B. Vennard	P. O. Box 304 West Burlington
Kansas	W9UEG	Melvin D. Kirby	Arlington
Missouri	W9OUD	Miss Letha Alendorf	Joplin
Nebraska	W9DI	William J. Bamer	Tobias
<b>NEW ENGLAND DIVISION</b>			
Connecticut	W1CTI	Frederick Ellis, Jr.	19 Merrill Rd. Norwalk
Maine	W1HIE	H. W. Castner	147 Church Damariscotta
Eastern Massachusetts	W1HIL	Larry Mitchell	94 Howard St. Melrose
Western Massachusetts	W1JAH	William J. Barrett	239 Columbia St. Adams
New Hampshire	W1BFT	Carl B. Evans	163 South Main St. Concord
Rhode Island	W1HRC	Clayton C. Gordon	192 Washington Ave. Providence
Vermont	W1KJG	Clifton G. Parker	Box 537 Morrisville
<b>NORTHWESTERN DIVISION</b>			
Alaska	K7ENA	Leo E. Osterman	Customhouse Wrangell
Idaho	W7EMT	Carl Kichelberger	Route 2 Kuna
Montana	W7FL	G. A. Woodhouse	Holter Dam Wolf Creek
Oregon	W7DXF	Harold W. Johnston	800 Jackson St. Pendleton
Washington	W7FCG	W. Beale	R. 4, School Ave. Walla Walla
<b>PACIFIC DIVISION</b>			
Hawaii	K6HTF	Francis T. Blatt	837 16th Ave. Honolulu
Nevada	W6BIC	Edward W. Heim	509 Claremont St. Reno
Santa Clara Valley	W6FBW	Elbert Amarantes	454 Washington St. San Jose
East Bay	W6T1	Horace R. Greer	414 Fairmount Ave. Oakland
San Francisco	W6JIS	Kenneth E. Hughes	622-36th Ave. San Francisco
Sacramento Valley	W6BDD	Vincent N. Feldtansen	113 South Quincy St. McCloud
Philippines	KA1GR	George L. Rickard	Box 849 Manila
San Joaquin Valley	W6KUT	Edwin A. Andress	2921 North Van Ness Blvd. Fresno
<b>ROANOKE DIVISION</b>			
North Carolina	W4CYB	W. J. Wortman	P. O. Box 500 Morganton
South Carolina	W4BOE/ANG	Ted Ferguson	1213 College St. Columbia
Virginia *	W3GWQ	Frank S. Anderson, Jr.	4703 New Kent Ave. Richmond
West Virginia			
<b>ROCKY MOUNTAIN DIVISION</b>			
Colorado	W9EHC	Carl C. Drumeller	819 East Dale St. Colorado Springs
Utah-Wyoming	W7CLG	Ernest E. Parshall	Salt Creek Electric Plant Midwest, Wyoming
<b>SOUTHEASTERN DIVISION</b>			
Alabama	W4DGS	James F. Thompson	12 Clanton Ave. Montgomery
Eastern Florida	W4PEI	Carl G. Schaal	Waucoma Apts. Clermont
Western Florida	W4AXP	Oscar Cederstrom	Lakeview Hotel De Funiak Springs
Georgia	W4AGI	Leland W. Smith	2010 Pennsylvania Ave. Augusta
West Indies (Cuba-Isle-of-Pines-Porto Rico-Virgin Islands)	CM2OP	Mario de la Torre	Escobar 110 (Altos) Habana, Cuba
<b>SOUTHWESTERN DIVISION</b>			
Los Angeles	W6MQM	Ralph S. Click	1038 Milwaukee Ave. Los Angeles
Arizona	W6KAM	Marson B. Hull	617 North Fourth Ave. Phoenix
San Diego	W6JRM	Howard K. Breedlove	R. 2, Box 636 San Diego
<b>WEST GULF DIVISION</b>			
Northern Texas	W5DXA	Lee Hughes	125 N. Main St. Childress
Oklahoma	W5GTF	Russell W. Battern	431 South Buchanan Enid
Southern Texas	W5BHO	Dave H. Calk	6013 Garrow St. Houston
New Mexico	W5BNI	Dr. Hilton W. Gillett	Lovington
<b>MARITIME DIVISION</b>			
Maritime	VE1DQ	A. M. Crowell	69 Dublin St. Halifax, N. S.
<b>ONTARIO DIVISION</b>			
Ontario	VE3SG	F. H. B. Saxon	302 Lee Ave. Toronto, Ont.
<b>QUEBEC DIVISION</b>			
Quebec	VE2CO	Lindsey G. Morris	Apt. 6, 4510 Girquard Ave., N.D.G. Montreal, P. Q.
<b>VANALTA DIVISION</b>			
Alberta	VE4GE	C. S. Jamieson	581 W. Riverside Drive Drumheller, Alta.
British Columbia	VE5HP	J. Hepburn, Jr.	335 Foul Bay Road Victoria
<b>PRAIRIE DIVISION</b>			
Manitoba	VE4AAW	A. W. Morley	747 McMillan Ave. Winnipeg
Saskatchewan	VE4SV	Arthur Chesworth	1071 4th Ave., N. W. Moose Jaw

\* Officials appointed to act until the membership of the Section choose permanent S.C.M.s by nomination and election.



## CATHODE MODULATION IS HOT!

If you are building a new rig for cathode modulation or re-building your old one (and who isn't?) you will be interested in eliminating as many "bugs" as possible. These will help.

Power wire wounds for the high voltage bleeder, grid and cathode bias resistors. They stay put — they keep your tubes in the sockets, not in the wastebasket.

M-1034 — Tapped 25,000 ohm bleeder and bias resistor for low power stages, insulated for 1000 volts to ground, can be mounted flat against chassis. Neat.

Type PR 25 and 50 watt rheostat for *panel* control of that critical grid bias in the final. Where more resistance is needed than in the rheostat use a fixed resistor in series.

MW-2J for filament center tap. Mounts flat on chassis, bypass condensers are easily hooked across lugs.

WW-3 precision meter shunts and multipliers. One meter can be switched to do the work of several. As stable as your Aunt Hattie.

Parasitic suppressors (see May *QST*). Easily made from Type F resistors. Useful in mercury vapor rectifiers, beam power tubes and at grids of your final amplifier.

BT insulated metallized and BW insulated wire wound resistors for the resistance coupled speech amplifier. Prevent distortion. Preserve that Harvard accent.

Type "CSM" metallized controls for A.C.C., speech input control, etc. Bakelite base elements, smooth tapers, pigtail connection to rotor and five finger contact keep them quiet.

With a Type MP resistor you can tune up and adjust your transmitter into a dummy antenna *under load* without being a pest on the air. Measure your RF power output with an ammeter in series with this resistor. Then slap all that signal into Timbuktu with a terminated rhombic. These MP resistors *work* (and at any frequency).

Take a squint at our listing in the 1940 ARRL Handbook or get an IRC catalogue from your jobber.



# THE AMERICAN RADIO RELAY LEAGUE

## Directors

*President*  
EUGENE C. WOODRUFF ..... W8CMP  
234 W. Fairmount Ave., State College, Pa.

*Vice-President*  
GEORGE W. BAILEY ..... W1KH  
74 Webster Road, Weston, Mass.

*Canadian General Manager*  
ALEX REID ..... VE2BE  
169 Logan Ave., St. Lambert, P. Q.

*Atlantic Division*  
WALTER BRADLEY MARTIN ..... W3QV  
Box 612, Roslyn, Pa.

*Central Division*  
R. H. G. MATHEWS ..... ex-W9ZN  
4534 Dover St., Chicago

*Dakota Division*  
FRED W. YOUNG ..... W9MZN  
107 Hanover St., Mankato, Minn.

*Delta Division*  
E. RAY ARLEDGE ..... W5SI  
P.O. Box 286, Pine Bluff, Ark.

*Hudson Division*  
KENNETH T. HILL ..... W2AHC  
115 Willow St., Douglaston, L. I., N. Y.

*Midwest Division*  
FLOYD E. NORWINE, JR. .... W9EFC  
7405 Hiawatha Ave., Richmond Heights, Mo.

*New England Division*  
PERCY C. NOBLE ..... W1BVR  
37 Broad St., Westfield, Mass.

*Northwestern Division*  
RALPH J. GIBBONS ..... W7KV  
c/o United Air Lines, Portland, Ore.

*Pacific Division*  
J. L. McCARGAR ..... W6EY  
66 Hamilton Pl., Oakland, Calif.

*Roanoke Division*  
H. L. CAVENESS ..... W4DW  
State College Station, Raleigh, N. C.

*Rocky Mountain Division*  
GLEN R. GLASSCOCK ..... W9FA  
2164 So. Corona St., Denver

*Southeastern Division*  
BENNETT R. ADAMS, JR. .... W4EY  
1512 Grove Place, Homewood, Ala.

*Southwestern Division*  
CHARLES E. BLALACK ..... W6GG  
1273 Main St., El Centro, Calif.

*West Gulf Division*  
WILLIAM A. GREEN ..... W5BKH  
801 Ross St., Abilene, Texas

THE AMERICAN RADIO RELAY LEAGUE, INC., is a non-commercial association of radio amateurs, bonded for the promotion of interest in amateur radio communication and experimentation, for the relaying of messages by radio, for the advancement of the radio art and of the public welfare, for the representation of the radio amateur in legislative matters, and for the maintenance of fraternalism and a high standard of conduct.

It is an incorporated association without capital stock, chartered under the laws of Connecticut. Its affairs are governed by a Board of Directors, elected every two years by the general membership. The officers are elected or appointed by the Directors. The League is non-commercial and no one commercially engaged in the manufacture, sale or rental of radio apparatus is eligible to membership on its board.

"Of, by and for the amateur," it numbers within its ranks practically every worth-while amateur in the nation and has a history of glorious achievement as the standard-bearer in amateur affairs.

Inquiries regarding membership are solicited. A bona fide interest in amateur radio is the only essential qualification; ownership of a transmitting station and knowledge of the code are not prerequisite. Correspondence should be addressed to the Secretary.



HIRAM PERCY MAXIM, FIRST PRESIDENT

## Officers

*President* ..... EUGENE C. WOODRUFF, W8CMP  
State College, Pa.

*Vice-President* ..... GEORGE W. BAILEY, W1KH  
Weston, Mass.

*Secretary* ..... KENNETH B. WARNER, W1EH  
West Hartford, Connecticut

*Treasurer* ..... ARTHUR A. HEBERT, W1ES  
West Hartford, Connecticut

*Communications Mgr.* ..... F. EDWARD HANDY, W1BDI  
West Hartford, Connecticut

*General Counsel* ..... PAUL M. SEGAL  
1026 Woodward Building, Washington, D. C.

Address all general correspondence to the administrative headquarters at West Hartford, Connecticut.

# "IT SEEMS TO US—"

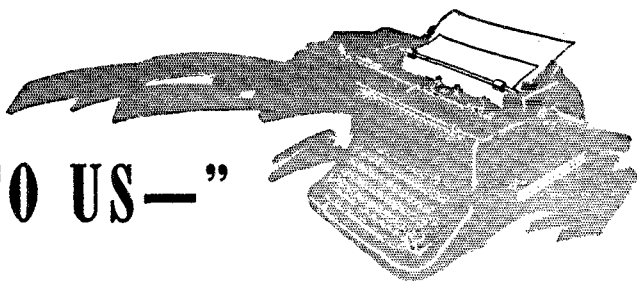

## OUR RESPONSIBILITY

NOVEMBER *QST* has been out just a few days as we sit here writing this page. We know that we must say something more to you fellows about the absolute continuing need to leave the w-r out of our radio conversations. We are experimenters, not pundits. Our interest is radio, not power politics. We can scarcely find better words to express our opinion of the need that lies before us than by quoting from this page last month:

*It continues to be of transcendent importance that we refrain from discussing on the air any manifestation of the war and any subjects that might have military interest for an interceptor. To the extent that you value your right to operate, let that be your code, unflinchingly!*

Heaven only knows what the future of amateur radio will be when this trouble is over. From all over the world pitiful letters are reaching us indicating that foreign amateurs believe that the only hope lies in the continuation of a strong A.R.R.L. For instance:

Whatever happens, I hope the A.R.R.L. will survive. Indeed, the hams all over the British Empire must surely realize now, more than ever before, the friend we have in the A.R.R.L. If, after the slaughter is over, we find we can still give a "Test," judging from the present trend of affairs we shall owe it all to you. Don't disappoint us.

And another:

... When it is over, we will want to get back on the air again. It lies with you W's to keep your grip. Only your organization and immense strength can save us any bands after this catastrophe. We leave it to you.

We may have to start from scratch and build up international amateur radio anew, country by country. We are hopeful that amateurs will give so convincing a demonstration of their value that their governments will consider it wise national policy to encourage them anew when peace is restored. But frequencies are valuable and it is perfectly apparent that what happens will depend largely upon what the U. S. A. is then doing as an example. Not

only our own future but theirs depends upon our unity and success in this country. Let each amateur take that thought to heart, and govern himself accordingly. We in the Americas are now the custodians of amateur radio for all the world, for all future generations. If anything happens to us here, it will be curtains for our whole art. Our only hope lies in the continuation of a strong American Radio Relay League. Don't let anything happen to amateur radio in this country through fault of yours!

## THE NEW U.H.F. DEPARTMENT

YOU know that special insulation is required for the ultra-high frequencies, but do you know what a u.h.f. conductor is? Well, in our particular case it's the chap who conducts our new *QST* department, "On the Ultra Highs," beginning in this issue. He is that well-known ultra-high man, Ed Tilton, W1HDQ, "on Wilbraham Mountain, eight miles east of Springfield, Massachusetts."

We've long needed a u.h. department. The time is more than ripe to establish a special place in the mag for the u.h.f. men whose technique and problems differ so radically from the rest of amateur radio. Here will be paraded the special accomplishments of the pioneers in new territory, the reports of their activities and plans. We know that the u.h.f. workers will enjoy the department. We hope that those on the outside looking in will find in it the necessary stimulation to carry resolutions into action and get into this most fascinating field.

In appointing *QST*'s first non-resident contributing editor we have been fortunate in getting the collaboration of a u.h.f. worker who is not only close to home but who is qualified beyond peradventure. Ed Tilton came into amateur radio on the 5-meter band — for the particular purpose of working u.h.f. — in June of 1933. From that date he has been continuously active on "five," with intermittent work on all bands from  $1\frac{1}{4}$  to 160. For his first four years his main interest was in portable work (the on-the-hoof variety), and he has carried pack sets on his back to the top of about every worth-while bump in central and southern New

England. He was, incidentally, the top-scoring 56-Mc. station in the A.R.R.L. Field Days in 1934, '5 and '6. Since early this year, W1HDQ has been located in a tower on Wilbraham "Mountain," 850 feet elevation, conveniently close to his home in Springfield. Since May 1st W1HDQ has worked over 175 stations on the 56-60 band, in eighteen states, seven U. S. call areas and one VE district. Its reliable day-and-night summer-and-winter range is well in excess of 150 miles, with communication up to 400 miles on air-bent work when conditions are favorable. Tilton carries in his head the descriptions of hundreds of ultra-high stations,

particularly their antenna systems. He lives, eats and sleeps u.h.f.

Now you u.h.f. fellows: This is *your* department. It's for you, but it can't get along without you. Tilton can report the picture, centralize dope and act as your emissary at Hq. *only* if you write in to him what you and your local gang are doing, and what with. It lies right in your laps now. Give him the right kind of cooperation and we can really go to town with a u.h.f. column. Address him either at Hq. or at 329 Central St., Springfield, Mass., whichever is more convenient for you. But write in!

K. B. W.

---

★ **S P L A T T E R** ★

---



He's a hero to the small fry — and why not? He knows their pocketbooks, their abilities, their needs. His breezy style makes his stories an enjoyable event even to those not interested in his subject. And his manifest enjoyment of ham radio is worthy a lad of years several decades less than his. Well, when you get right down to it, who'd ever have guessed that he *wasn't* a young squirt — if we hadn't let you in on this photograph?

Of course you looked at these last lines first, so you know by now that it's Fred Sutter, W8QBW, who's at the wheel of this boat at W8QDK, the summer QTH. His latest pceewee transmitter is described elsewhere in this issue.

When Admiral Byrd prepared to leave on another Antarctic expedition, that was news. When it was learned that the radio crew planned to work amateurs, that was *ham* news. The trouble was that this was a government expedition, and it was fitting out at the Boston Navy Yard, and the Navy controlled the communications picture, and the traditional Navy taciturnity stood in our way. No publicity, no pictures — especially no pictures! But blood is thicker even than

salt water, and there were hams in the radio crew, and . . .

So shortly before the scheduled sailing Clint DeSoto and Frank Beaudin, our photographer, rolled up to the Navy Yard and got the story. (Let's tip our hats, boys, to a genial commander, and the guard who watch-dogged the camera, and one or two others who smoothed the way for this *QST* exclusive.)

— . . . —

**Our Cover**

The prow of the *North Star* as she appeared while docked at the Army Base, Boston, Mass., prior to departure for Little America.

— . . . —

**FEEDBACK**

**Fig. 1, p. 28, October QST**

$R_4$  should be 0.15 megohm.

Screen and suppressor elements reversed on the 1852. The suppressor should be grounded and the screen connected to  $R_{17}$  and by-passed by  $C_1$  to ground.

**Chart, p. 28, November QST**

Between 10 and 100  $\mu\text{f.d.}$  on scale there are only 8 divisions. The 60  $\mu\text{f.d.}$  line was omitted.

— . . . —

We have been asked, "Why do you have to change a perfectly good 'Strays' heading that has served admirably as a *QST* feature for twenty years?"

We aren't! "Strays" continue to be humorous or interesting incidents from the outside, but we have always felt that we should have a spot available to talk shop from an editorial standpoint to the reader about anything of mutual interest, be it about authors or articles or chit-chat on policies or ideas concerning *QST*.

# Byrd Antarctic Expedition to Use Amateur Radio

**KCAUSA, KCAUSB and KCAUSC Will Work Amateurs from Antarctic Ice; All Expedition Personal Traffic To Be Handled via Amateur Networks**

**BY CLINTON B. DESOTO,\* WICBD**

In the face of a winter which promises few operating thrills in the way of international DX, there comes the welcome announcement that amateur radio is again going with Byrd to the South Pole. Here's the dope on the expedition's radio set-up, particularly with respect to plans for communication with amateurs.

**W**HEN the U. S. Antarctic Service Expedition, commanded by Rear Admiral Richard E. Byrd, establishes its bases on the ice-locked continent of Antarctica early next year, it will also establish amateur radio stations operating in the 7-, 14- and 28-Mc. bands for contact with the folks back home.

More than that, these stations will be expected to carry the entire load of personal messages from members of the ice party. "We will be depending on the hams to handle all our personal traffic," Clay Bailey, chief radioman in charge of communications, announced just before the sailing of the U.S.M.S. *North Star* from Boston harbor in early November.

This is part of a broad general communications plan created by Bailey on behalf of the expedition. The result of weeks of intensive effort on the part of himself, his staff and the manufacturers, the plan provides complete installations for two bases, a Snow Cruiser and five outposts, as well as airplanes and ships. It involves dozens of transmitters and receivers, thousands of replacement tubes, and a multitude of miscellaneous parts and pieces.

In order to understand the details of this system, it is first necessary to understand the general scope and purpose of the expedition itself.

The U. S. Antarctic Service was established by Act of Congress in June of this year, and Admiral Byrd was placed at its head. The purpose of this service is to colonize Antarctic regions explored by Byrd and Lincoln Ellsworth, and thereby claimed by the United States. These claims are now being challenged by other nations; indeed, the whole continent of Antarctica is a scene of

conflict with claims and counter-claims on the part of Argentina, France, Germany, Great Britain, Norway and the U. S. A.

It was Admiral Byrd's idea that the best way to establish this country's right to these regions was by colonization. He therefore conceived the project of establishing semi-permanent bases in Antarctica, to which men would be sent on a basis of one year's enlistment. Between the bases there would be outpost stations, and from the bases motorized expeditions would carry out detailed explorations throughout the region, especially in the vicinity of the South Pole.

This idea he succeeded in selling to President Roosevelt, with the result that last June Congress established the Service and appropriated \$340,000 for the expedition. Since that time the process of organization, of assembling equipment and personnel, has been going forward at an intensive

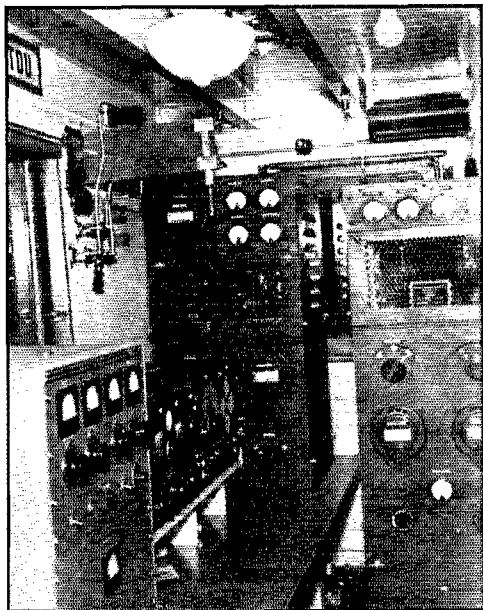

The operating position on the U.S.M.S. *North Star*, WTDU. At left is one of the special 125-watt Harvey transmitters used by the expedition.

\* Assistant Secretary, A.R.R.L.

pace. Two ships were obtained. The rugged old veteran, *Bear of Oakland*, purchased by Admiral Byrd for his second Antarctic expedition and now sold by him to the government for \$1, was refitted with Diesel engines and complete new equipment and commissioned in the U. S. Navy. To carry the bulk of the load, the Alaskan supply motorship *North Star*, a husky modern built in 1932, was obtained from the Department of Interior.

The expedition now totals some 160 men. There will be 25 or 30 men at each of the two main bases and a crew of three at each of five outposts. The remainder constitute the crews of the two vessels. Some of these men come from the various participating government services; others are volunteers at a dollar a year.

The radio crew on the expedition is made up of regular enlisted Navy personnel, volunteers transferred to this assignment from their regular posts in the service. Clay Bailey, their chief, is a veteran of the Antarctic. He was chief operator on the second Byrd expedition.

Second in command is an active and enthusiastic ham, Elmer L. Lamplugh, who has been on the air with spark and c.w. since 1920. A highly-qualified technical man, while on duty at New London and Boston Navy Yards he has recently been operating a  $\frac{1}{2}$ -kw. 20-meter 'phone under the call W1LWD.

It is Lamplugh who will be in charge of radio work at the East Base. With him there will be



Clay Bailey, veteran of the Antarctic, chief of communications on the U. S. Antarctic Expedition.

E. B. Perce, who in addition to being RM1C is co-pilot of one of the Navy Condors, and Howard T. Odom, a regular Naval operator.

At the West Base, where Bailey will be in personal charge, he will have J. A. Reese, ex-W4CTA, and W. R. Giles, a technical sergeant in the Marines who is also a co-pilot. Another Marine in the communications end is Felix L. Ferranto, W6NDH, who is scheduled to be radio operator on the Snow Cruiser.

The two ships, leaving Boston in November, are scheduled to arrive at the ice floe some time during January or February. Then the work of setting up the West Base will begin. Its supplies and men unloaded, the equipment of the East Base party will then be loaded aboard and taken to its destination. A hectic period of preparation, and then the long winter night, when radio will come into its own. . . .

The communications picture divides itself into three parts. Basically, the radio circuits will be Naval, with all official communications handled over Navy stations and with operating conducted in accordance with Navy practice. A number of N calls and frequencies have been assigned in this connection.

Broadcasting is, of course, an important part of the picture. In contrast to the second expedition, this time it will be non-commercial in nature. The pick-up will be through RCA Communications, and all networks will have equal right to use the broadcasts. They are expected to come through two or three times weekly. For this purpose regular commercial calls have been assigned — KRTK at the West Base, KRTC at the East Base, and KRTA on the Snow Cruiser. All regular mobile marine frequencies are licensed, as well as 6425, 9135, 11,060, 12,862.5, 23,100 and 30,660 kc.

The third phase — amateur radio — is an equally important part of the communications set-up. In contrast to the second expedition,

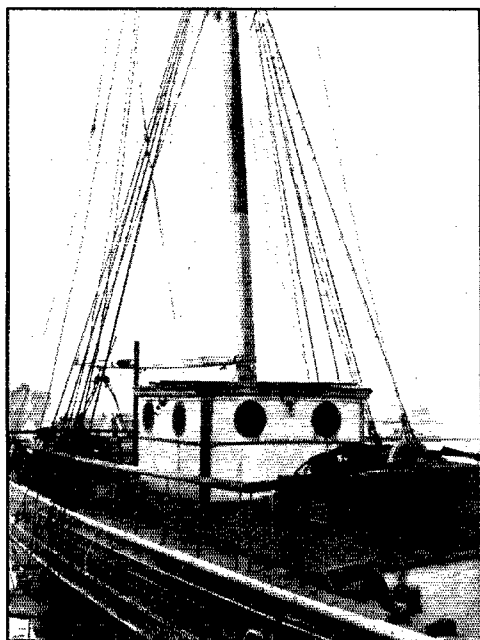

Looking aft to the radio shack on the U.S.S. *Bear*. Here the operators will live, sleep and work during the voyage.



when prearrangement restricted all personal traffic to Mackay circuits and in consequence little amateur work was done, amateurs this time are expected to handle everything but the official government traffic going through Navy channels.

Three amateur calls have been assigned — KC4USA at the West Base, KC4USB at the East Base, and KC4USC on the Snow Cruiser. These stations will use the regular 500-watt transmitters

given precedence. In particular, he discourages the suggestion made by a number of amateurs and clubs of putting up special directive arrays aimed at the South Pole. In the first place, he points out, the continent of Antarctica is a big place, and the two bases will be widely separated. Their eventual locations cannot be disclosed, and a sharp beam might therefore conceivably miss the actual location by quite a few degrees.

The bands which will prove best, the localities they will work most readily — these, too, are purely speculative. Conditions now are on a different portion of the solar cycle than during previous expeditions, and conclusions are therefore difficult. They do anticipate, however, that KC4USA at the West Base will find it easier to work Pacific Coast stations, while KC4USB will probably have better luck with W4's and East Coast stations. As a guess, the bands will probably peak at KC4USB some five to seven hours ahead of KC4USA.

Operation in ham bands will probably be carried on chiefly during the winter months (summer here); during the Antarctic summer the radio personnel will be too busy working with exploring parties, making hourly observations and carrying out their other duties, for much hamming.

Turning now to the equipment in use, we find that there are three general classifications. Class 1 is designed for long-distance work with the U. S. and ships en route north. Class 2 is for medium-



Two of the radio crew: Howard T. Odom, RM1C, left, and J. A. Reese, RM1C and ex-W4CTA, right.

assigned for long-distance duty at the bases, together with rhombics and Vee's, and should push a thumping signal up here. The frequencies now listed are 7075, 14,150 and 28,300 kc., although QRM may cause changes after operation begins.

Not only will amateur circuits carry personal message traffic back and forth, but Bailey hopes that during the long winter night when time permits the radio crew will be able to arrange direct 10- and 20-meter 'phone contacts with stations in the home towns of expedition members, so that they may talk directly with the home folks. If there is a member of the ice party from your city, you will find yourself on the preferred list when answering KC4US — CQ's!

When will these stations be on the air? Well, if all goes well, the West Base — KC4USA — should be in commission by March 1st. It will probably be another two months or more before KC4USB at the East Base is going. As for the Snow Cruiser, KC4USC, that will depend on several factors.

Meanwhile, no schedules and no commitments are being made. "Schedules? Don't mention the word to me," is the way Clay Bailey dismisses the pleas of individual amateurs and groups from various parts of the country who have attempted to line up prearranged contacts. "We won't know until we get down there whom we can work. And then we'll take the best and most dependable signals, and concentrate on them for our schedules and our important traffic."

In the meantime, he emphasizes, no one will be

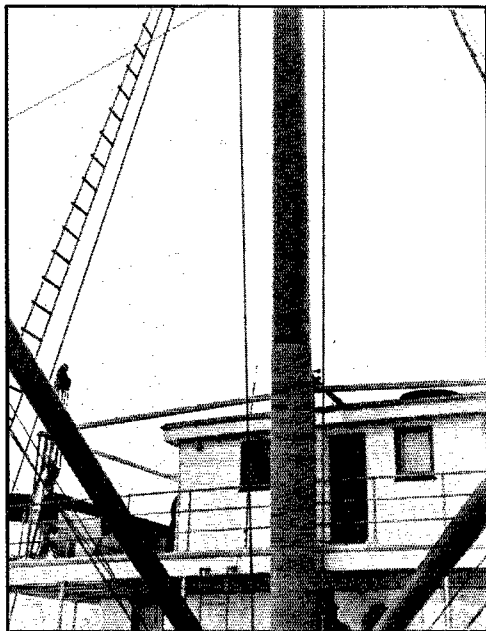

The radio room of the *North Star*, atop the main cabin, as seen from the stern. Operating room left of the doorway, operator's quarters (with curtained window) right.



Clay Bailey, left, and E. L. Lamplugh, right, being interviewed by W1CBD at Expedition headquarters in Building 28 of the Boston Navy Yard. Lamplugh, second in command of the communications staff, has been active as W1LWD. Here, in the midst of sleeping bags and tents, alcohol stoves and dog sleds, Arctic boots and Byrd cloth, and the innumerable other requirements of such an expedition, the information presented in this article was first released to amateurs via QST.

range work, across the Antarctic continent and with ships on the Dunedin and Valparaiso runs. Class 3 is for short-haul stuff, around the bases, between outposts, and so on.

This equipment is used in a wide variety of installations. Besides the bases and outposts, there are ships, aircraft and trail outfits — all supplied with radio. There are four aircraft with the expedition. Two large Navy Condors will carry the brunt of the heavy work. These husky biplanes are considered more rugged for such service than other available types. The Admiral's personal ship is a trim Barkley-Grow, while the fourth airplane is the Snow Cruiser's pick-a-back Beechcraft. There are four converted Army light tanks for hauling trail outfits, as well as the usual dogs and dogsleds. All these mobile units are also radio-equipped.

At the bases themselves, of course, all classes of equipment will be used. The West Base will have two Class 1 transmitters, which are special Harvey rigs with 813's in the final giving 500 watts on c.w. and 400 Class-B modulated watts on 'phone. These transmitters have panel-switching of five crystals and an optional master oscillator. The East Base has one of these, with another on the U.S.S. *Bear*.

Class 2 transmitters are also to be set up at each base, as well as on the Snow Cruiser, the two Condors, and on the U.S.M.S. *North Star*. These are 125-watt Harvey sets with an 814 final, master-oscillator controlled.

There are twenty-five outpost — Class 3 — sets; these will be distributed all over the place. They are rated at about 30 watts, 'phone and c.w., master-oscillator controlled. They operate from 12-volt batteries powered by windchargers. A d.c. SW3-type receiver is used with these outfits, equipped with a 5-inch speaker. In addition to being used at all the bases and outposts and for some field purposes, these outfits will be installed in the Barkley-Grow and Beechcraft.

In addition, there are the trail sets, interesting little field-powered gadgets delivering about 12 watts on c.w. from a Hartley 801. Power — 400

volts at 70 ma. — is derived from Signal Corps hand-cranking generators. Two types of antennas are provided, one a collapsible 13-foot vertical rod, the other a 35-foot horizontal wire. The receivers are modified SW3's built in the same cases as the transmitters, using 1.4-volt tubes and operating from b.c.l.-type combination portable batteries. The complete outfit weighs 31 lbs. The transmitter tunes from 4 to 7.5 Mc.; the receiver has two sets of coils and goes to 9 Mc. to permit reception of time signals and weather data.

Each base is also equipped with three 2½-meter transceivers to be used in lieu of telephone wires during unloading operations and for local exploratory work. This is in itself an innovation; no telephone circuits whatsoever are being taken along on the expedition, and all communication will be by radio.

Except for the SW3's in the trail sets and the transceivers, all receivers are Hammarlund Super-Pro's and HQ-120's. There will be two of each in combination cabinets at each base, one of each on the Snow Cruiser, and various combinations on the ships. The Condors will be equipped with HQ-120's.

For the most part the equipment is orthodox in design. Among the more interesting special features is the fact that no mercury-vapor rectifier tubes are used. It seems that they are slow to vaporize in cold temperatures. Instead, all rectifiers are high-vacuum types. There are no electrolytic condensers in any part of the equipment. Clay Bailey says that at temperatures below zero you might as well use a block of wood. All crystals are heated in individual oven holders of the miniature plug-in type.

No particular precautions must be taken against humidity and corrosion as long as the building interiors are maintained at reasonably even temperatures. Outside, the intense cold drives all moisture from the air and it is excessively dry. In fact, the snow itself is so dry that it makes a moderately good insulator; during the second expedition, for example, one 600-foot

transmission line lay in the snow for most of its length with no apparent loss of power.

Except for the special Navy antennas, no final antenna specifications have been drawn. A number of rhombics, single Vee's and multiple Vee's have been cut and laid out, but these are subject to modification during erection and subsequent actual use. No rotary antennas are being provided; the handicaps of ice and wind seemed too great. A great many sectionalized bamboo masts are being taken along, permitting great flexibility in possible layouts, height, etc. in erecting the long-wire fixed arrays. Something like 100,000 feet of antenna wire will accompany the expedition, most of it stranded phosphor bronze aircraft wire equivalent to about No. 12, the balance No. 18 solid copper-clad aircraft wire.

In addition to all the general communications equipment listed above, each base and outpost will be equipped with high-frequency radio direction-finding equipment for use in checking the position of aircraft and trail parties. D/f equipment will also be used on the Snow Cruiser, and on airplanes in flight. The aircraft, in fact, will use transmissions from the individual bases and outposts as flight-course beams. As long as the radio equipment holds out it will be impossible for anyone to get lost.

In contrast to previous expeditions, when the main base used gasoline engines and storage batteries for power, all power on this expedition is to be generated directly by Witte Diesel systems. Each base has two generators, one  $7\frac{1}{2}$  and the other 3 kva. These will operate 24 hours a day, delivering 110-volt 60-cycle single-phase a.c.

Insofar as possible, every possible need has been foreseen and every contingency provided for on this expedition. In the case of the radio equipment, vast quantities of replacement tubes and parts have been provided, on top of accepting only the most dependable components at the start. The same attitude has prevailed throughout the expedition. Only the best, and plenty of that, is used. This explains why the

project, originally budgeted at \$350,000, is actually costing nearer \$2,000,000.

It is worth emphasizing in this connection that the current expedition is not a private venture as were the previous Byrd expeditions, but is, instead, a government project. Various government departments are cooperating in equipping and manning it, and the result should be the finest in equipment, personnel, and performance.

This fact should be kept in mind by amateurs working the expedition in later months. Remember that the boys behind these KC4US—calls will have responsibilities beyond their ham status; be considerate of them. In the first place, they are Navy men on Navy duty, and will be forced to conform rigidly with routine. In the second, they will have a heavy load of duties at all times during their stay in Antarctica, and the time available for casual ragchewing will be limited.

Another point to be remembered in working these stations is that it will not be just a stone's throw from one to the other. On the contrary, the base stations will be halfway 'round the world from each other! The exact locations cannot now be disclosed, but if it is remembered that the Antarctic continent is as large as the United States and Mexico put together, and that these stations will be on opposite sides, some concept of the magnitude of the operations can be had.

At the same time the importance of this colonizing effort can be estimated. The present worth of Antarctica is negligible, true; but its potential

worth can be great indeed. It has strategic value, as a base for whaling operations and for future air transport. It has substantial deposits of coal, oil, copper, nickel and tin which could well provide an invaluable reservoir for future ages when more accessible sources run low. From the scientific standpoint, the region offers manifold opportunity for discovery and observation, particularly in the fields of geology and meteorology.

Nor is Antarctica as isolated as the elaborate preparations for current expeditions might indicate. It is only about 600 miles to South

*(Continued on page 25)*

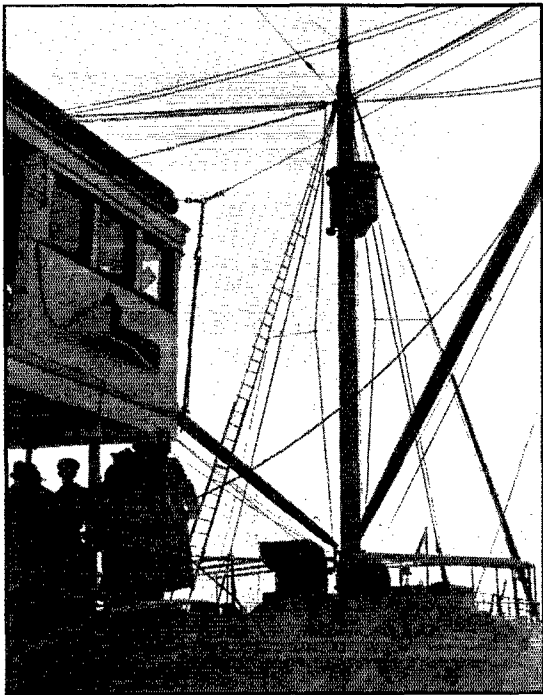

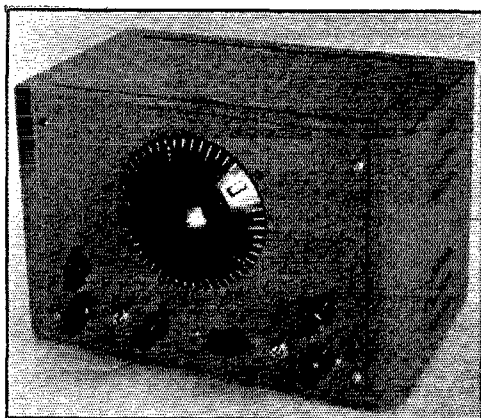

# A Four-Tube Superheterodyne

BY BYRON GOODMAN,\* WIJPE

A four-tube superheterodyne, dressed up by putting it in a gray-crackle-finished cabinet. The chassis is fastened only to the panel, for easy removal.

## ***Building Performance into the Small Receiver***

SOME time ago we built a small five-tube double-regenerative superhet<sup>1</sup> and loaned it to a local amateur friend of ours. We didn't bother him about it for quite a while, and he apparently became rather fond of the thing. However, the old yen to change something somewhere finally overcame us, and we told him if he would return the receiver for a spell we'd put in an 1852 mixer for him, instead of the original 6L7, and bribed him with tales of the additional performance he could expect. He fell for it and returned the receiver, after extracting our promise that we wouldn't change anything else.

That was his undoing. We looked the old job over, figuring how the 1852 could best be put in the circuit, and decided that the old layout could be considerably improved upon, from the standpoint of appearance and short leads. The net result was that the old receiver was completely rebuilt, and the new receiver bears no resemblance to the old one. Our friend had removed the original drum dial and substituted a National PW dial, so we had no qualms about retaining the dial in the new receiver. Previously we had decided that the use of a dial of this type would scare away many potential builders who might think the dial too expensive an item to include in a small receiver, but we now feel that such is not the case, in view of our friend's action. There isn't any doubt that the dial, with its excellent reduction ratio, is well worth while on a stable receiver with good handsread. The receiver to be described has had its coverage adjusted so that it tunes a kc. per dial division on 7 and 14 Mc., slightly more than this on 3.5 Mc., and 5 kc. per division on 28 Mc. A little care in adjusting the spread makes the receiver convenient for approxi-

imating the frequencies of incoming signals, within the limits of drift and day-to-day changes, since the tuning is almost exactly straight-line-frequency. So don't let the dial scare you—it's well worth it.

In looking around for a cabinet, we couldn't resist the new streamlined jobs made by Par-Metal and, since these aren't expensive and add plenty to the appearance of the finished set, we had no qualms about using one. However, except for the manufactured cabinet and the high-powered dial, there isn't much in the receiver that isn't absolutely necessary for best performance and reliable operation.

### ***The Circuit***

There is nothing tricky in the circuit, as can be seen from Fig. 1. The 6J5 high-frequency oscillator is capacity-coupled to an 1852 mixer. The 1852 is the logical choice for the mixer in a small receiver because of its gain and excellent signal/noise ratio. The mixer is made regenerative by a small coil in the plate circuit coupling back into the input circuit, but we should like to point out right now that the receiver should first be built *without* the mixer regeneration (which seems to give some fellows a lot of trouble) and then added after everything is working first rate. By doing this, there is no confusion in trouble shooting, since if the mixer regeneration is left out, any that shows up must first be eliminated before it is deliberately introduced. That sounds like a paradox, but what we're after is *controlled* regeneration, and it's the uncontrolled kind that gives the boys trouble.

The 1852 mixer feeds into one stage of regenerative 1600-kc. amplification. Here again we don't have to worry about trouble from the regenerative amplification, because the method used can be easily controlled and should give no trouble.

\* Assistant Technical Editor.

<sup>1</sup> Goodman, "A Double Regenerative Superhet," *QST*, March, 1938.

We had some doubts at first as to the degree of single-signal reception that could be obtained with regeneration at 1600 kc., but it surpassed our highest hopes and, with care in adjustment, an S7 signal will be down to S3 on the other side of zero beat. This degree of single-signal, coupled with the fact that the 1600-kc. i.f. gives a much better image ratio than a 450-kc. one would, is full justification for the high-frequency i.f.

The second detector is one-half of a 6C8G, and the other half of the tube is used as the b.f.o. Plenty of headphone volume is obtained right out of the second detector, and no audio amplification was included in the receiver. However, it's a simple matter to add a stage of audio if you use a loud speaker.

### Construction

The most important point in building a receiver that is to be used on the higher frequencies is mechanical rigidity. In this case, the chassis, made of a simple U of aluminum, is reinforced along the edges by half-inch brass angle which results in a very sturdy chassis. The panel supports none of the components and is fastened to the chassis by three screws. The panel, in turn, is fastened to the cabinet by the four self-tapping screws furnished for the purpose, and the chassis

Use an 1852 mixer for sensitivity, a high-C 6J5 for h.f.-oscillator stability, and a stage of regenerative 1600-kc. i.f. amplification for selectivity and image reduction, and you can build a four-tube superhet whose performance belies its simplicity.

is anchored to the cabinet at the rear by drilling and tapping the chassis to take two screws that go through the back of the cabinet. The cabinet comes out out at the rear, so it isn't necessary to drill holes in the cabinet to pass the power cable, antenna binding posts and phone jack. The chassis is 2 inches high at the rear and 1½ inches high in the front, to clear the lower lip of the cabinet's panel opening.

The first step in construction, after the chassis has been made and fitted, is to mount the PW dial upside down on the center line of the chassis. This is necessary so that the dial will be high on the panel without raising the condensers too much above the chassis. The four screws that hold on the top plate of the dial are replaced by four longer ones that hold the dial to the chassis. In turning the dial upside down, the small front

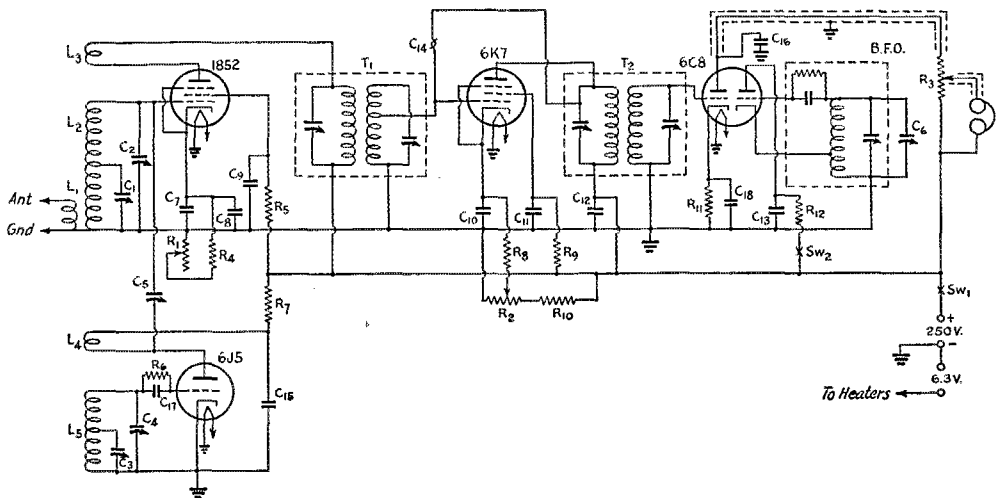
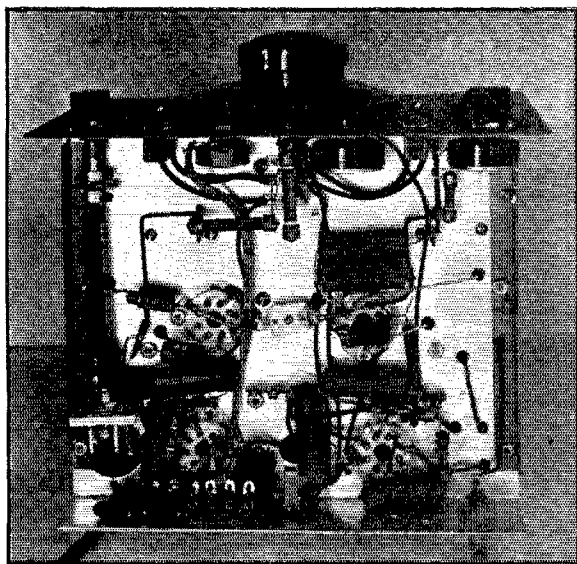

Fig. 1 — Circuit of the four-tube superhet.

- |  |   |
|--|---|
| C <sub>1</sub> — 15- $\mu$ fd. midget, mixer tuning condenser (Hammarlund HF-15).        | C <sub>4</sub> — 100- $\mu$ fd. midget, oscillator bandset condenser (Hammarlund HF-100). |
| C <sub>2</sub> — 35- $\mu$ fd. midget, mixer bandset condenser (Hammarlund HF-35).       | C <sub>5</sub> — 30- $\mu$ fd. adjustable mica (National M-30).                           |
| C <sub>3</sub> — 35- $\mu$ fd. midget, oscillator tuning condenser (Hammarlund MC-35-S). | C <sub>7</sub> to C <sub>13</sub> — 0.1- $\mu$ fd. 400-volt paper.                        |
| C <sub>15</sub> , C <sub>16</sub> — 0.005- $\mu$ fd. mica.                               | C <sub>14</sub> — Push-back wire twisted together. (See text.)                            |
| C <sub>17</sub> — 0.0001- $\mu$ fd. mica.  | R <sub>2</sub> — 10,000-ohm wire-wound variable.  |
| C <sub>18</sub> — 5- $\mu$ fd. 25-volt electrolytic.                                     | R <sub>3</sub> — 50,000-ohm variable.   |
| R <sub>1</sub> — 1000-ohm wire wound variable.   | R <sub>4</sub> , R <sub>8</sub> — 300 ohms, ½-watt.                                       |
| T <sub>1</sub> — 1600-kc. i.f. transformer (Millen 62161).                               | R <sub>5</sub> — 150,000 ohms, 1-watt.  |
| T <sub>2</sub> — 1600-kc. i.f. transformer with grid connection                          | R <sub>6</sub> — 0.1 megohms, ½-watt.   |
|  | R <sub>7</sub> — 15,000 ohms, 1-watt.   |
|  | R <sub>9</sub> — 50,000 ohms, ½-watt.   |
|  | R <sub>10</sub> — 65,000 ohms, 1-watt.  |
|  | R <sub>11</sub> — 40,000 ohms, ½-watt.  |
|  | R <sub>12</sub> — 1000 ohms, ½-watt.  |
|  | BFO — 1600-kc. b.f.o. assembly (Millen 63163).  |





◆

The chassis is braced underneath by two strips of half-inch brass angle. The leads from the audio volume control are shielded to reduce body capacity effects, and a small aluminum shield fits over the b.f.o. condenser (upper right corner). The controls, as seen from the bottom, are mixer gain at the left, on-off switch, i.f. gain, audio gain, b.f.o. switch, and b.f.o. pitch control at the right.

◆

aluminum bushing on the dial must be inverted so that the dial numbers will read properly.

After the dial assembly has been secured to the chassis, the tuning condensers are fastened to the chassis and adjusted to the proper height by mounting them on small bushings filed down to the proper dimensions. The oscillator tuning condenser is turned around to allow more space on the chassis. Flexible couplings connect the dial assembly to the tuning condensers. The mixer and oscillator hand-set condensers are mounted on the front of the chassis. The photographs show the location of the other parts and no detail is necessary.

Before finally mounting the second i.f. transformer, it should be removed from the can and the grid lead, which is normally taken from a tap on the coil, should be connected to the stator of the grid-coil tuning condenser. At the same time, a small hole is drilled in the side of the shield can opposite the point the grid lead is brought out, and a small piece of push-back wire is soldered to the plate connection of the primary and brought out the hole. This is to be used later to make the i.f. amplifier regenerative.

The antenna terminal post is made by taking one of National's Victron terminal strips and sawing it in half. The smaller hole is enlarged to take one of the binding posts, and the binding post that goes through this enlarged hole holds the strip to the chassis. In this way, one side of the antenna coil is always grounded, but it is normally used this way and, in the case of balanced input from a low-impedance line, grounding one side of the line won't hurt things much.

All r.f. leads in the mixer and high-frequency oscillator circuits are made with heavy wire.

Where they must be brought through the chassis,  $\frac{1}{4}$ -inch holes are drilled to clear the wires and the rigidity of the wire keeps it centered through the holes. D.c. and i.f. wiring is done with the usual push-back wire, except for the leads from the audio-volume control running to the second detector plate and the 'phone jack, which are run through shielding braid to reduce any body-capacity effects that may show up. The shielding should of course be grounded at several points on the chassis.

#### Adjustment

After the set has been wired and the wiring has been checked, the 6C8G and the 6K7 should be placed in their sockets, for alignment of the i.f. If a signal generator is available, it will be a simple matter to align the i.f. amplifier on 1600 kc. or thereabouts (the exact value is not important) in the usual manner. The i.f. amplifier should be aligned with the plate lead from the second i.f. transformer well removed from the grid of the 6K7 — we don't want to put in the regeneration until after the amplifier has been aligned. If no signal generator is available, a wire can be draped from the b.f.o. over to the plate lead on the first i.f. transformer and the i.f. lined up on the noise.

When the i.f. amplifier has been aligned, the 1852 should be placed in its socket and a mixer coil wound *without* the small plate coil  $L_3$ , substituting in its place a short length of wire to close the circuit. The input i.f. transformer can then be readjusted slightly to compensate for the capacity added by the 1852 plate circuit. Now that the 1852 is in the circuit, the wire from the plate lead on the second i.f. transformer can be

brought back to the grid of the 6K7 tube, and it will be found that advancing the i.f. gain control will make the i.f. oscillate. This can easily be detected if the b.f.o. is on, since a beat note will result. The wire from the plate should be untwisted from the 6K7 grid lead until the i.f. amplifier oscillates with the i.f. gain control very nearly in the fully-advanced position. In our case, a half twist of the plate wire around the grid wire gave sufficient feedback. Be sure, of course, that there is no direct connection, else the B supply will be shorted.

With the i.f. aligned and set in a non-oscillating condition by backing off the i.f. gain control, the 6J5 and the proper oscillator coil can be placed in their sockets. By connecting an antenna and adjusting the oscillator bandset condenser, it should be possible to hear signals and, using your freq.-meter or other source of signal, the high-frequency end of the band can be located. This should be done with the tuning dial set at 450 or so. When the edge has been located, the tuning dial should be turned until the low-frequency edge is heard, assuming, of course, that we have a signal source for that frequency. If the low-frequency end comes at some number higher than 50, there isn't enough bandspread, and the bandspread tap should be moved down on the coil. If the low-frequency edge comes at a number lower than 50, or can't be found at all, it indicates too much bandspread, and the tap should be moved up. Once the process is understood, it becomes a simple matter to adjust the coil to the proper range. In the receiver described, the coils were adjusted so that the 3.5-Mc. band runs from 470 to 30, the 7-Mc. band from 400 to 100, and the 14- and 28-Mc. bands from 450 to 50.

With the proper spread on the oscillator coil, little is left but to adjust the mixer coil. The mixer circuit is peaked at the high-frequency end of a band by adjustment of the bandset condenser and the tuning dial is then turned to the low-frequency end. If the mixer bandset condenser must be adjusted to a higher capacity to peak at the low-frequency end, it indicates too much bandspread on the coil and the tuning tap must be moved up on the coil. If the capacity must be reduced, too little bandspread is present and the tap must be moved down. It is much less complicated than it sounds.

In our particular model with the coils as described in the coil table, the proper setting of the oscillator bandset condenser was at half capacity for 7 and 14 Mc., and at nearly full capacity for 3.5 and 28 Mc. The mixer bandset condenser should be set at nearly full capacity on all bands, since the 1852 seems to work better out of a medium-*C* circuit than a low-*C* one. If the mixer circuit resonates with anything less than two-thirds the bandset capacity in, take turns off the mixer coil until the proper amount of capacity must be used to bring the circuit to resonance at the signal frequency. This should be done before the final adjustment of the bandspread tap, since removing turns from the coil will necessitate readjustment of the bandspread tap.

When the coils have been adjusted for proper bandspread and tracking, the oscillator must be adjusted. In the model described, provision was made for adjustment of coupling by means of a small 30- $\mu$ fd. variable coupling condenser, but it worked out so that we opened the condenser wide and adjusted the coupling for each band by

*(Continued on page 78)*

A top view of the chassis shows the mixer section at the upper left, the oscillator section at upper right and, from left to right in the foreground, the input i.f. transformer, the 6K7 i.f. amplifier, the output i.f. transformer, the 6C8C combination second detector and b.f.o., and the b.f.o. assembly. Note the wire coming from the output i.f. transformer back to the grid of the 6K7, for making the i.f. amplifier regenerative.

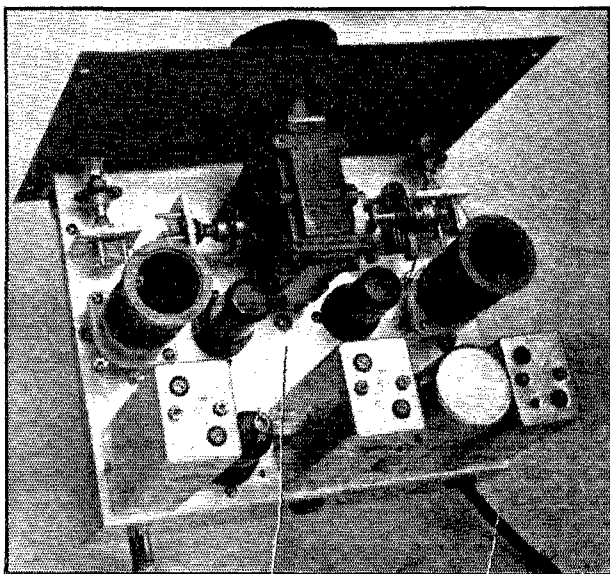

# A Homemade Exponential Horn

*Increasing the Efficiency of the Small Dynamic Speaker*

BY E. E. COMBS, JR.\* ex-W6CTN

WHEN the family budget won't stand for two radio receivers in the house, and the ham communications receiver can't be sacrificed for a high-fidelity b.c. receiver, something must be done to keep the little woman happy. We think we have the answer, because, with a half-way decent 8-inch speaker and 2 watts of audio from the receiver, we have b.c. reception worth showing off to the neighbors and — more important — it didn't ruin the budget.

\* Box 232, Brownstown, Ind.

Let's first consider the characteristics of the dynamic speaker. Ordinarily, a good dynamic will provide good response up to 5000 cycles and, with a baffle at least 8.5 feet in diameter, is supposed to get down into the lows somewhere around 30 cycles, theoretically. Unfortunately, the baffle arrangement has two disadvantages: the bulky size where space is a premium, and the poor efficiency of the cone of an 8-inch dynamic speaker trying to shake air into activity at low frequencies where our ears are relatively insensitive. The problem, therefore, is to get an arrangement that will get down to the low frequencies without the handicaps of a baffle.

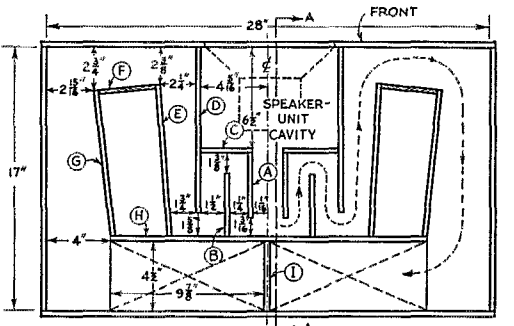

All partitions are of  $\frac{1}{4}$ " Plywood 8" high, excepting "I" which is  $12\frac{3}{4}$ " high

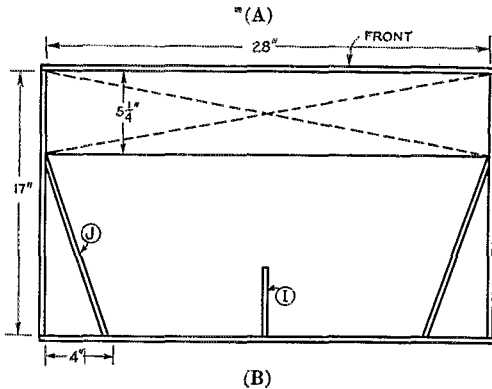
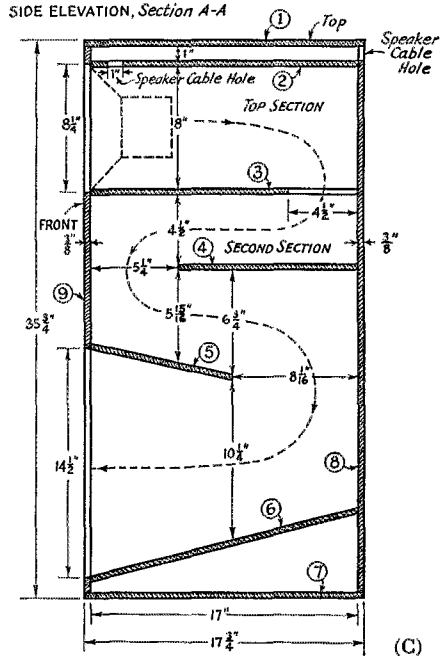

Fig. 1 — Detail of the assembly of the exponential horn. The view in the upper left (I-A) is a plan view of the top section; the plan view of the second section (I-B) is directly below. The view at the right is a side elevation along section A-A.

- A —  $4\frac{5}{8}$  inches by 8 inches.
- B —  $4\frac{1}{8}$  inches by 8 inches.
- C —  $3\frac{3}{4}$  inches by 8 inches.
- D —  $10\frac{3}{8}$  inches by 8 inches.
- E —  $9\frac{1}{4}$  inches by 8 inches.
- F —  $3\frac{1}{4}$  inches by 8 inches.
- G —  $9\frac{1}{4}$  inches by 8 inches.
- H — 20 inches by 8 inches.
- I —  $4\frac{1}{2}$  inches by  $12\frac{3}{4}$  inches.
- J —  $17\frac{3}{4}$  inches by  $28\frac{3}{4}$  inches,  $\frac{3}{8}$ -inch thick.



- 2 — See Fig. 2.
- 3 — See Fig. 2.
- 4 —  $28\frac{1}{8}$  inches by  $11\frac{3}{4}$  inches.
- 5 —  $28\frac{3}{8}$  inches by  $9\frac{1}{4}$  inches.
- 6 —  $28\frac{1}{2}$  inches by 18 inches.
- 7 —  $17\frac{3}{4}$  inches by  $28\frac{3}{4}$  inches,  $\frac{3}{8}$ -inch thick.
- 8 —  $28\frac{3}{4}$  inches by 35 inches,  $\frac{3}{8}$ -inch thick.
- 9 — See Fig. 2.

All pieces  $\frac{1}{4}$ -inch thick unless otherwise noted.

Fortunately, one of the characteristics of the dynamic speaker is that at low frequencies the cone acts very nicely as a piston. As the frequency goes up, the cone finally ceases to act as a unit, with the result that only a small part of the cone around the voice coil is doing the major part of the work. These facts fit our auditory requirements very nicely, for the air is practically incompressible at the higher frequencies and air columns can be set into vibration quite easily. At the extremely low frequencies, the air is compressible to some extent and the sound waves spread considerably after leaving the speaker, resulting in a reduction of the intensity of vibration. At the same time, the ear is much less sensitive to low frequencies, so that it becomes necessary to increase the actual amplitude of the air waves in order to hear them satisfactorily.

There are two common methods of setting a proportionately larger amount of air into vibration at the lower frequencies. The response of the audio amplifier can be adjusted so that the low frequencies are accentuated, but the increased amplitude of the cone movement tends to lead away from linearity, producing some distortion, and such an increase in amplitude takes considerable audio power. The other method is to increase the effective piston area of the cone, thus creating a greater displacement of the air with the same piston amplitude. A large effective area can be obtained either by use of a large dynamic speaker or by using a small speaker with an exponential horn. In considering dynamic speaker sizes, we find that the high-frequency response tends to drop off as the size of the cone is increased. Thus, if we want a speaker large enough for good bass response, we have to sacrifice the highs. On the other hand, an 8-inch dynamic will give us good response up to 5000 cycles and, with the aid of an exponential horn, we can get very good bass response.

The exponential horn has three general dimensions which determine its response characteristics. The throat area coupled with the size of the cavity between the diaphragm and the throat determine the highest frequency that will pass into the horn. The rate of expansion of the horn determines the lowest frequency that will travel down the horn. The mouth area of the horn determines the lowest frequency that will enter into the air without reflection, caused by what might be called a mismatch of impedances.

Interested in taking three watts of audio and an 8-inch speaker and rattling the windows of the room? You'll do that, and increase the fidelity of the overall audio system at the same time, if you build the simple exponential horn described on these pages.

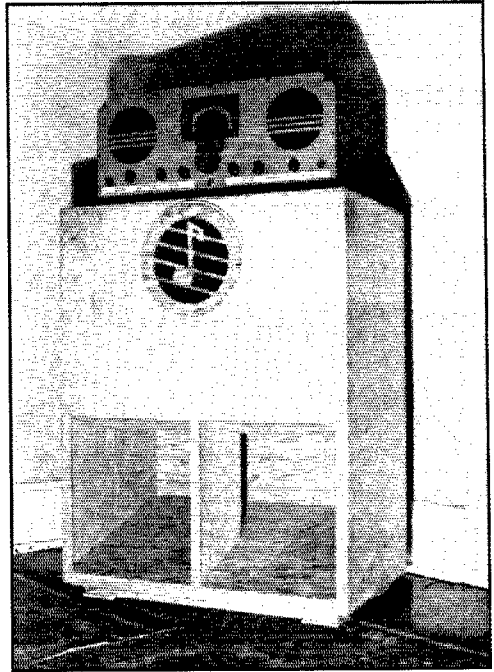

A simple homemade exponential horn with an ACR-155 mounted on top to give an idea of the size of the gadget. The low notes pass through the horn and come out at the bottom — the high notes are radiated directly through the grille at the top.

The dynamic speaker on the ordinary baffle works very nicely down to around 200 cycles before the response drops off, so that a frequency in this neighborhood will be the highest that need pass down the horn. The lowest frequency that we would like to hear (if possible) is around 30 cycles, so this determines our rate of expansion. To keep within reasonable outside dimensions we will make our horn mouth area 385 square inches, which gives a low frequency of 80 cycles before reflection takes place. With these limitations, we can expect to get a low-frequency response such that the lower limit will be between 30 and 80 cycles, depending upon the acoustic characteristics of the room in which the horn is placed. Again referring to the piston effect of the cone, we see that we now have an effective piston area of 385 square inches, which is about ten times the area of the cone of the 8" dynamic speaker, or equivalent to a 22-inch diameter dynamic speaker.

For those interested in the mathematical design of an exponential horn for a dynamic speaker, reference to the *I.R.E. Proceedings* of October, 1936, and *Radio Engineering* by F. E. Terman will give all the necessary data and references from which calculations can be made.

The photograph gives the general appearance of the finished speaker cabinet which is the ex-

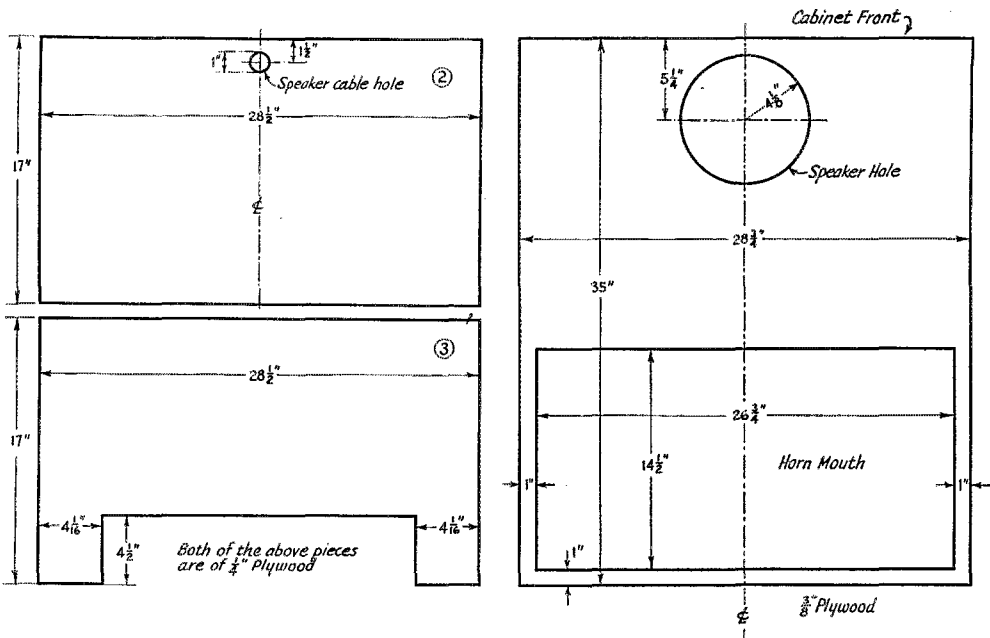

Fig. 2 — Detail of pieces No. 2 (upper left), No. 3 (lower left) and No. 9 (right).

ponential horn in disguise. The ACR 155 was placed on top of it to give an idea of its size. The grilles were left off so that the beginning and ending of the "works" could be seen. With the exception of a 1-inch cavity between the top of the horn proper and the top of the cabinet, the entire space is taken up by the folded exponential horn. The cabinet is arranged so that the highs from around 200 cycles and up come directly from the dynamic speaker and the lows from around 200 cycles on down come through the horn.

Fig. 1-A shows a plan view of the "top section" which also provides space for the dynamic speaker. The partitions are made of  $\frac{1}{4}$ -inch plywood. In this section, the horn is split into two paths so that use could be made of the entire space, these two paths joining together again at the back of the top section. Fig. 1-B shows the second section, plan view and Fig. 1-C shows a side view of all sections.

#### Constructional Details

The tools required to make this cabinet consist of a hand-saw, hammer, plane, vise, chisel and at least two small "C" clamps. The total materials used were two pieces of  $\frac{1}{4}$ " plywood 4 feet by 8 feet, a piece of  $\frac{3}{8}$ " plywood 4 feet by 8 feet, some 1 inch brads, and glue.

First, cut all internal pieces to dimension, making sure that all pieces making up the labyrinth for the "top section" are all 8 inches high, that pieces No. 2, 3 and 4 have the same length and that pieces No. 2 and 3 have the same width.

The pieces (a) and (c) and (d) are next assembled, using 1-inch brads and glue, making up two units which are identical in shape. Then, pieces (e), (f) and (g) are assembled to give two identical units which are then both attached to piece (h). The positions of pieces (a), (b), (c), (d), (e), (f), (g) and (h) are then laid off on piece No. 3, for both halves, giving a pencil-line outline that looks like Fig. 1-A. Next, nail holes are laid off on piece No. 3 between the lines which are  $\frac{1}{4}$ -inch apart, spacing holes about 1 inch from the end of any partition. Lay piece No. 3 on top of piece No. 2 and drill the holes with a No. 50 drill. Alongside the lines drawn on piece No. 3, tack small strips of wood so that the partitions will fit snugly, using enough strips to hold the entire labyrinth in place. Then, put slow-drying glue on the edges of the partitions and on the places where they are to be attached to piece No. 3, and nail the pieces (a), (b), (c), (d), (e), (f), (g) and (h) in place. Now, remove the guide strips and repeat the glueing process on the top edges of the partitions. The piece No. 2 can then be nailed in place, using the nail holes previously drilled, making sure that everything is being attached squarely in place. The "top section" is then complete.

The next step is to attach pieces (j) to piece No. 4. As was done for the top section, first lay off an outline on piece No. 4, to get something that looks like Fig. 1-B, and then mark off the nail holes. Lay piece No. 4 on piece No. 3, which is the bottom of the "top section," and bore the nail holes with a No. 50 drill. Now pieces (j) can be



attached to piece No. 4, first, then to piece No. 3, with brads and glue.

The sides are then laid out with pencil lines to show the outline of the "shelves" that are going to be attached. The results should look like Fig. 1-C for the left end of the cabinet, when facing the cabinet, and the exact opposite for the right side. After the positions of pieces Nos. 2, 3, 4, 5 and 6 are drawn, nail strips of wood, which are straight and as long as the sides are wide, on the outside of the lines. Try a piece of  $\frac{1}{4}$ -inch plywood between the strips to make sure that there is a tight fit. Now, with these strips as guides, make sawcuts to a depth of  $\frac{1}{8}$  inch. Remove the guide strips and chisel out the wood between the saw cuts to get grooves which will take the ends of the  $\frac{1}{4}$ -inch plywood "shelves." When the sides are laid out in the above manner, be sure that one side is the exact reverse of the other. When the grooves are finished, lay out and drill nail holes in the manner before described. Beginning with the "top section," glue and nail pieces Nos. 2, 3, 4, 5 and 6 in place. The result will be a rather odd-looking "bookcase" affair.

In the top of the "top section," just over the speaker cavity, is a 1-inch hole to permit passage of the speaker plug and cable. There is another in the back of the finished cabinet for the same purpose. By this arrangement, the cavity between the top of the "top section," and the top of the cabinet serves as a damper against loss of air pressure through the speaker-cable hole in the horn.

The front, back, top and bottom can then be put in place in the order mentioned. By the time you get this far, this latter job will seem comparatively easy.

The speaker opening and the mouth of the horn can be covered with grilles and cloth, or just pieces of bronze fly-screen with simple frames, according to the inclination of the builder. No great detail will be given as to how the speaker is to be mounted for the reason that the outside dimensions of various makes of 8-inch dynamic speakers are not always the same. In some cases, the speaker can be mounted directly on the grille and for others, where the speaker is a bit larger than the opening provided in the cabinet, the outside rim of the speaker can be attached to the outside of the horn. Such details as the above and the cabinet finishing are left up to the individual taste.

The dynamic speaker must be of good quality and it should have a cone central angle of around 90°. Speakers with flatter cones are not able to work against the air-column load without buckling; though the buckling is not audible, the bass is just left out.

#### General

The results obtained with this horn were more than gratifying. In the first place, the receiver listed among the family properties has only a single 6F6 audio output but it is capable of fur-

nishing all the volume that a home or a small auditorium can stand. In fact, the efficiency of the dynamic speaker seems to have been raised considerably and it is no trouble at all to rattle the windows in the room without running the audio up to the distortion point. This was not possible with the same dynamic speaker on a 3-foot square baffle that was used before the horn was made. The bass response is very good and there are no indications of cabinet or speaker resonance. With normal volume, the throb of a bass drum or bass fiddle is sufficient to vibrate the floor without giving the impression that it is being forced.

## Modern Radio Course Resumed

**T**HIS novel course of instruction in modern radio principles which has been broadcast in past years over station WIXAL (now WRUL) is commencing its fourth year under the direction of Dr. C. Davis Belcher, well-known radio instructor and former radio inspector. The series is, as in the past, presented by the World Wide Broadcasting Foundation, a non-profit society specializing in educational programs of many kinds.

With four years of successful experience teaching this course by radio, and by utilizing the many suggestions received from listeners all over the world, Dr. Belcher has been able to make the current series of broadcast even more instructive and helpful than before. The course, which runs for an entire college year, is divided into four sections of eight lectures each, with a periodic review for questions and answers from the short-wave audience. Starting November 13th, for example, there will be a new section dealing with the fundamentals of electrical engineering and radio circuits, including the use of storage batteries, microphones and amplifiers.

The lesson broadcasts run for a full hour, during which one complete subject is covered. So popular has the course become that the original Monday night lecture at 10:00 p.m. E.S.T. on 11.73 Mc. is being repeated by electrical transcription on Fridays at 4:00 p.m. over 11.79 Mc., and again the following Monday evening at 7:00 p.m. on 6:04 Mc., for the benefit of additional listeners or those who missed the regular period.

Each student is equipped with a printed lesson book which is mailed to his home when he registers with this unique radio university. The books, one for each of the four sections, are supplied at a cost of one dollar each to cover the expenses of preparation and mailing. Each lesson book is complete with circuit diagrams, charts and radio terms to help the listener follow his instructor. Full details of the course and enrollment cards may be obtained by writing to WRUL-World Radio University, University Club, Boston, Massachusetts.

# ★ WHAT THE LEAGUE IS DOING ★

## ELECTION NEWS

**D**IRECTORS and alternates are being chosen this autumn in Canada and in half the divisions in the States. The Canadian section is choosing between VE2BE, the incumbent, and VE3PL for Canadian General Manager; and between VE2AB, the incumbent, and VE3AZ for alternate. In the Southeastern Division there will be a new director, as Mr. Adams, W4EV, has decided to relinquish the office through press of other duties, and the members are now choosing between W4ASR and W4DGS. W4EV is, however, a candidate for election as alternate, as is also W4CNZ.

In the Atlantic, Dakota, Delta, Midwest and Pacific Divisions, after the elimination in some cases of nominees who for one reason or another were not eligible, there remained only the incumbents as eligible nominees. As a result, Messrs. Walter Bradley Martin, W3QV; Fred W. Young, W9MZN; E. Ray Arledge, W5SI; Floyd E. Norwine, jr., W9EFC; and J. L. McCargar, W6EY, have been declared reelected for the 1940-1941 term in these divisions, respectively. Similarly, in the Delta and Pacific Divisions W5DKR and W6FBW, the respective incumbent alternates, were the only eligible candidates and have been declared reelected. However, in the remaining divisions balloting is now in progress to select alternates from the following candidates: Atlantic, W8CKO, W8BQ, W3CDQ. Dakota, W9ITQ, W9ADJ, W9EU. Midwest, W9MME, W9FAM.

Election results will be determined about December 20th and will be the subject of a special broadcast from W1AW.

## MEMBERSHIP GROWTH

**L**EAGUE membership has shown unbroken growth, at a steady and wholesome rate, for many years back. The membership in good standing at the end of recent calendar years was as follows:

1938.....	24,527
1937.....	23,664
1936.....	23,254
1935.....	22,600
1934.....	22,228
1933.....	18,979
1932.....	18,664

While figures for 1939 are not yet available, they will show a continuation of the steady onward march of your League. Amateurs appreciate their own organization, the only one that does things for amateur radio!

## A NOTE ON STADLER'S DEATH

**W**E READ in *Canadian Aviation* that unexpected light was thrown on the cause of the tragic airplane accident that cost the lives of VE2AP and VE2NI last winter, when film in a movie camera found in the wreckage was developed.

It was then revealed that, just prior to the crash, the plane had made several descents to low altitudes to enable pictures of a herd of caribou to be taken through the cabin window, and indicated that in a steep turn while near the ground the ship stalled and struck the frozen surface before it could be brought back into control.

John Stadler, VE2AP, was one of Canada's best-loved amateurs and was one of amateur radio's representatives to the Bucharest meeting of the C.C.I.R.

## CALLS ON LICENSE PLATES

**A** LITTLE article in *QST* early this year on the practice of the state of Michigan in assigning amateur calls on automobile license plates has stimulated similar attempts by amateurs in many other states. Unfortunately, we have not heard of any other state being successfully persuaded. And now, from information received from the Associated Amateur Radio Operators of Denver, it appears that even Michigan is abandoning the practice next year. The Denver club did a real job on their motor vehicle department, persuading the supervisor to get in touch with the Michigan authorities, which did put ham calls on plates; the Ohio authorities, who were said to be about to do it; and the m.v. people of Illinois and Washington, who were supposed to have it under consideration. The results are sad: Ohio says it has received numerous requests, but has flatly turned them down; will continue to do so. Illinois points to a legislative requirement and obviously has no intention of doing anything. Washington says it has emphatically refused to accede to such requests. And the lone champion of amateur rights, Michigan, says that it did put calls on plates this year, but that the system has resulted in widespread complaint from peace officers over difficulty of identification and has generally been unsatisfactory, and that the practice will be discontinued effective with the 1940 plates. Tough stuff, for it was a swell idea.

## FINANCIAL STATEMENT

THE League's routine operations for the third quarter of 1939 showed the usual summer deficit normal for that time of the year. However, we entered the last quarter a couple of thousand dollars better off for the year than at the same time last year. It is expected that the last quarter, which sees the appearance of the new *Handbook*, will yield a substantial gain, although the war in Europe is taking its toll in our business affairs to an extent not yet computable. Third-quarter figures:

### STATEMENT OF REVENUE AND EXPENSES, EXCLUSIVE OF EXPENDITURES CHARGED TO APPROPRIATIONS, FOR THE THREE MONTHS ENDED SEPT. 30, 1939

REVENUES		
Membership dues . . . . .	\$12,579.38	
Advertising sales, <i>QST</i> . . . . .	21,178.66	
Advertising sales, <i>Handbook</i> . . . . .	183.16 <sup>1</sup>	
Advertising sales, booklets . . . . .	500.00	
Newsdealer sales, <i>QST</i> . . . . .	11,021.39	
Handbook sales . . . . .	3,204.89	
Spanish edition <i>Handbook</i> revenues . . . . .	1.62	
Booklet sales . . . . .	1,981.11	
Calculator sales . . . . .	371.47	
Membership supplies sales . . . . .	1,811.25	
Interest earned . . . . .	548.88	
Cash discounts received . . . . .	187.13	
Bad debts recovered . . . . .	6.90	
		\$53,199.52
<b>Deduct:</b>		
Returns and allowances . . . . .	\$ 3,283.39	
Exchange and collection charges . . . . .	11.50	
Cash discounts allowed . . . . .	324.81	
Increase in reserve for newsdealer returns of <i>QST</i> . . . . .	220.91	3,840.61
Net Revenues . . . . .		\$49,358.91
EXPENSES		
Publication expenses, <i>QST</i> . . . . .	\$15,458.55	
Publication expenses, <i>Handbook</i> . . . . .	2,998.23	
Publication expenses, booklets . . . . .	1,073.25	
Publication expenses, calculators . . . . .	232.38	
Spanish edition <i>Handbook</i> expenses . . . . .	50.98 <sup>2</sup>	
Salaries . . . . .	23,974.83	
Membership supplies expenses . . . . .	1,200.30	
Postage . . . . .	1,048.73	
Office supplies and printing . . . . .	1,952.62	
Travel expenses, business . . . . .	1,153.71	
Travel expenses, contact . . . . .	1,048.45	
<i>QST</i> forwarding expenses . . . . .	1,338.26	
Telephone and telegraph . . . . .	581.19	
General expenses . . . . .	989.97	
Insurance . . . . .	161.07	
Rent, light and heat . . . . .	1,099.60	
General Counsel expenses . . . . .	261.28	
Communications Dept. field expenses . . . . .	163.71	
Headquarters Station expenses . . . . .	341.10	
Provision for depreciation of:		
Furniture & equipment . . . . .	299.01	
Headquarters Station . . . . .	448.89	
Total Expenses . . . . .		55,774.20
Net Loss before expenditures against appropriations . . . . .		\$ 6,415.29

<sup>1</sup> A debit item.

<sup>2</sup> A credit item.

## WWV Schedules

EXCEPT for the special broadcasts of WWV using 20 kw. as described below, WWV is now running a continuous schedule (day and night) on 5000 kc. with a power output of 1 kw. This continuous transmission is modulated with the standard pitch in music, 440 cycles per second.

Each Tuesday, Wednesday and Friday (except legal holidays), the National Bureau of Standards station, WWV, transmits with a power of 20 kw. on three carrier frequencies as follows: 10:30 to 11:30 A.M., E.S.T., on 5000 kc.; noon to 1:30 P.M., E.S.T., on 10,000 kc.; 2:00 to 3:30 P.M., E.S.T., on 20,000 kc. The Tuesday and Friday transmissions are unmodulated c.w. except for 1-second standard-time intervals consisting of short pulses with 1000-cycle modulation. On the Wednesday transmissions, the carrier is modulated 30% with a standard audio frequency of 1000 c.p.s. The accuracy of the frequencies of the WWV transmissions is better than 1 part in 5,000,000.

## Byrd Antarctic Expedition

(Continued from page 15)

America at the nearest point — a three-hour hop for a fast airplane. In fact, the expedition plans to get fresh meat and fruit by air from the mainland during the favorable months.

So you see the expedition is simply a crew of specialists going to a remote but not inaccessible place to do a lot of hard work in the hope that it may mean something worth while for posterity. There will be times when they're lonely or blue or when they feel like writing a letter home. And then it will be up to you to deliver the message.

## Silent Keys

IT is with deep regret that we record the passing of these amateurs:

William H. Burt, W5BRC, Jacksonville, Tex.

Stanley M. Breuer, W9ZWY, Lincoln, Nebr.

Percy J. Carr, W6JVV, National City, Calif.

F. E. Gaynor, VE2KD, ex-VO6J, Montreal, Que.

J. W. Hamilton, G5JH, Hardwicke, Glos.

Robert J. Kelly, W9VTC, Fargo, N. Dak.

John J. Kielich, Jr., W8MBQ, Buffalo, N. Y.

Erwin E. Praught, W9WDA, Duluth, Minn.

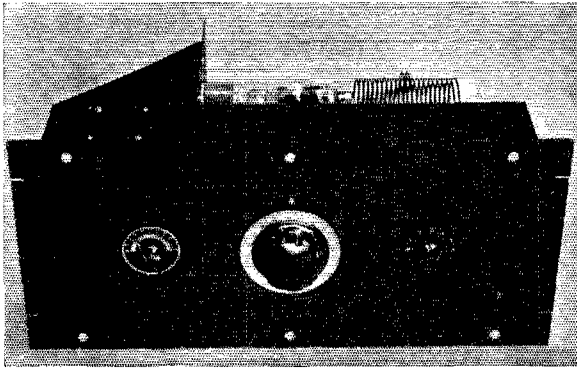

The three controls are arranged symmetrically. The plate-tank control is at the center with the grid-tank control at the left and the switch for the external milliammeter at the right.

If for no other reason than that you're becoming bored with the usual rack-mounting unit arrangement, you'll be interested in this amplifier. Aside from this, however, the construction presents all of the advantages of vertical construction without consuming vertical space. The important leads are short and the coils unusually accessible for changing, regardless of an overhanging unit above in the rack.

## "Dish-Type" Construction for the High-Power Amplifier

**Compact Unit Making Use of 812's and Components of Small Dimensions**

BY DON H. MIX,\* WITS

**T**HERE is nothing particularly new in "dish-type" construction for rack mounting. Its application has heretofore been confined pretty well to speech amplifiers and low-power r.f. units, however, because this type of construction does not normally lend itself well to the tubes and tank condensers of large physical size usually associated with high power. Within the past year or two, the size of medium-power tubes has been gradually reduced until now a pair of tubes capable of handling a half-kilowatt or so is about half the size of a pair of tubes such as the 203-A's formerly used for such a job. Those employed in this job are the new RCA type 812's whose characteristics will be found in October *QST*.

By isolating the rotors of a split-stator condenser from ground, and thereby limiting the voltage across the condenser to the peak r.f. value alone, the physical size of the condenser can be reduced by more than 50 per cent. This total reduction in size is sufficient to make the idea of dish-type construction entirely practicable for an amplifier of this order.

### Practical Features

Aside from the refreshing departure from the more or less cut and dried arrangements into which rack-mounting amplifiers have fallen, dish-type construction has certain practical ad-

vantages. By reference to the photographs, it will be seen that the tank coils may be mounted so that very little metal of the normal rack struc-

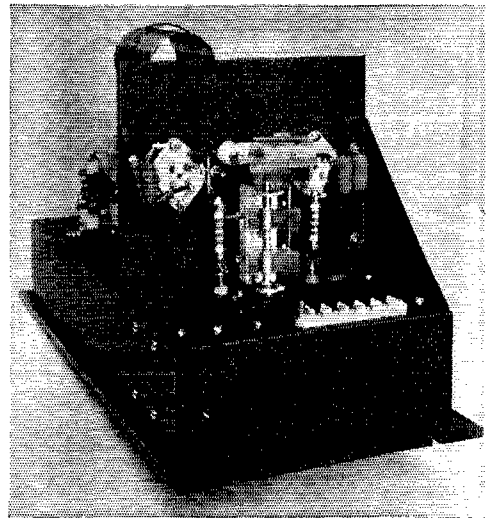

The grid end of the amplifier. The filament by-pass condensers, grid blocking condensers and r.f. chokes are arranged symmetrically about the tank coil and condenser.

\*Assistant Technical Editor.

ture is in the immediate fields of the tank coils — a condition almost impossible to approach in the usual form of construction with metal panels and side brackets. Plug-in coils are made much more accessible for changing and the direction of “pull” in removing coils is outward away from the rack rather than upward into the next rack unit above. Terminals may be mounted so that the wiring between rack units may be made inconspicuous and so that the chances of personal injury from accidental contact with exposed terminals at the rear are greatly reduced. Lastly, this form of construction usually reduces the required height of the unit which is a particular advantage in table racks where vertical space is at a premium. The required height in this case was four or five inches less than would have been necessary for the usual horizontal chassis construction.

#### *Individual Metering*

The circuit of the amplifier shown in the diagram is standard in every way except in the method of metering where a departure is made from usual practice. By means of the two-gang six-position switch, it is possible to measure the individual grid and cathode currents of each tube as well as total grid or total cathode currents. To accomplish this, two small filament

transformers are used, one for each tube, instead of a single large transformer. The meter is switched across shunting resistances in each circuit to simplify switching. The shunting resistances in the grid circuits are not critical in value so long as they are not less than 20 times the resistance of the 100-ma. meter. Meter resistance usually runs between 0.25 and 1 ohm in the 100-ma. size so that resistances of 25 ohms or so will have no practical effect upon the meter reading. In the cathode circuits, the shunting resistors should be carefully adjusted to provide a scale multiplication of ten. The full-scale readings when the meter is shifted to the cathode circuits will then be 1000 ma. These resistances in each case should be one-ninth of the resistance of the meter used. Those shown in the photograph were made with No. 22 enamelled copper wire wound on  $\frac{1}{4}$ " diameter rods of insulating composition. The total length of wire required for each of the resistances is about three feet. The exact length can be determined quite easily by experiment. Place the milliammeter in series with a battery and a variable resistance suitable to hold the current to 100 ma. and adjust the variable resistance until the meter reads full scale. Now take a piece of the wire with which the shunt is to be wound and connect the ends across the meter. Adjust the length of the shunt wire until the meter reading drops to 10 ma. and then cut off and wind on the form. If the re-

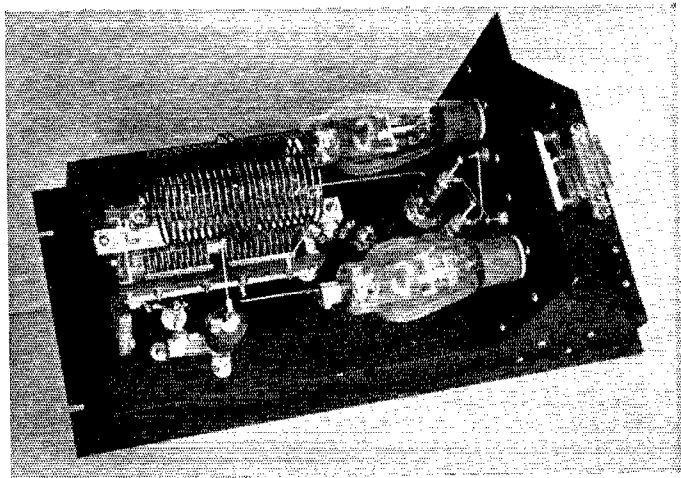

The plate end of the amplifier. The neutralizing condensers are mounted between the tubes. The leads from neutralizing condensers to the tank-condenser stators are dissimilar but of equal length, thereby preserving electrical symmetry.

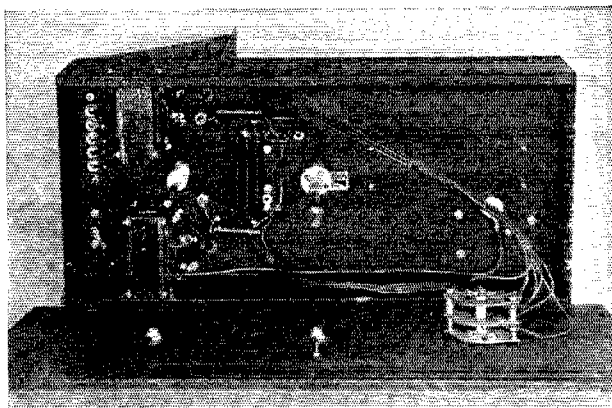

This view of the interior of the chassis shows how the two filament transformers are mounted and the condenser extension-shaft arrangement. The meter switch is mounted on the panel and connected with cabled leads. The grid leaks and meter shunts are mounted on fibre lug strips.

sistance of the shunt is too low (shunt wire too short) the meter reading will fall below 10 ma., while if the shunt resistance is too high (shunt wire too long), the meter reading will be above 10 ma.

### Assembly

Turning to the constructional details, the amplifier is assembled on a standard chassis 8" by 17" by 3" which is, in turn, mounted on an 8 $\frac{3}{4}$ " by 19" rack panel of  $\frac{1}{4}$ " crackle-finish Presdwood. The partition on which the tubes and grid-

circuit components are mounted is a 6" by 8" steel panel, a standard item as is, likewise, the pair of 5" triangular supporting brackets.

The plate tank condenser is mounted on four  $\frac{5}{8}$ " stand-off insulators and the coil jack bar is fastened to the condenser frame by means of a pair of brackets cut from  $\frac{1}{2}$ " wide brass strip bent to shape. The assembly is placed along the center line of the chassis and as far towards the end of the chassis as possible without hanging over. Then, when about an inch is cut off the condenser shaft, the end of the shaft will be in the right position to permit coupling to the drive shaft running through a bearing in the exact center of the chassis. The plate-circuit r.f. choke is easily identified in the photograph while the tank isolating condenser is fastened to the tank-condenser end plate and grounded at the other end to the chassis.

On the partition, holes centered 3 $\frac{1}{2}$  inches from the rear edge and 1 $\frac{1}{8}$  inches from top and bottom are cut for the National CIR tube sockets. The sockets should be orientated so that the plates of the tubes will be in a vertical plane when the unit is mounted in a vertical rack. The grid tank condenser is mounted with a machine screw through the hole which is left in the ceramic base when the shield between the two condenser sections is removed. It should be placed with the front edge of the ceramic base  $\frac{1}{8}$  inch from the front edge of the partition and with the shaft of the condenser extending through a clearance hole on the center line of the chassis. The rotors are not grounded since experience has shown that an amplifier of this type usually neutralizes more readily without the ground connection and excitation usually divides more evenly between the two tubes. It should be noticed that the shaft of the condenser used does not run along the center of the mounting, but  $\frac{1}{4}$  inch to one side, and this should be taken into consideration when mounting so that the shaft will be central on the chassis. The grid tank coil is mounted just to the rear of the condenser. The partition is placed 5 inches from the end of the chassis. Small feed-through points are used in passing the neutralizing leads through the partition and for the bias leads through the chassis.

The two neutralizing condensers are a new compact type with low-loss polystyrene dielectric. They are mounted so that they are easy to get at to adjust with their adjusting screws protruding toward the rear. They should be placed back near the partition so as to remove them as far as possible from the center of heat generated by the tubes.

The two filament transformers are small enough to be mounted underneath the chassis along with the grid leaks and meter-shunting resistors. Both the ceramic terminal strip and

(Continued on page 76)

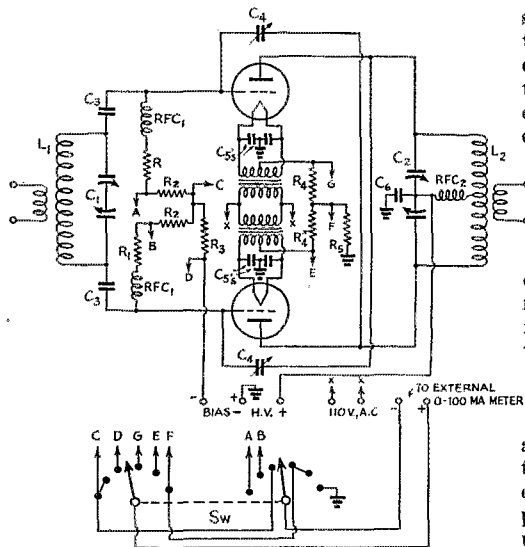

Fig. 1—Circuit diagram of compact high-power amplifier.

- C<sub>1</sub>—100  $\mu$ fds. per section (Hammarlund MCD100M).
- C<sub>2</sub>—100  $\mu$ fds. per section (Cardwell MT100GD), 0.07-in. spacing.
- C<sub>3</sub>—500  $\mu$ fds. mica, 600-volt.
- C<sub>4</sub>—Neutralizing condenser 8 to 10  $\mu$ fds. max. (Millen 15003).
- C<sub>5</sub>—0.01- $\mu$ fd. paper, 600-volt.
- C<sub>6</sub>—0.002- $\mu$ fd. mica, 5000-volt.
- R<sub>1</sub>—Grid leak, 6000 ohms, 10 watts.
- R<sub>2</sub>—Grid-current meter shunt, 25 to 50 ohms, 2-watt.
- R<sub>3</sub>—Same as R<sub>2</sub>.
- R<sub>4</sub>—Cathode-current meter shunt. See text.
- R<sub>5</sub>—Same as R<sub>4</sub>.
- L<sub>1</sub>—National AR series coils with center link (variable-link type recommended).

Substitute coils may be wound on 1 $\frac{1}{2}$ -in. diameter forms as follows:

- 3.5 Mc.—44 turns, 2 in. long.
- 7 Mc.—22 turns, 2 in. long.
- 14 Mc.—10 turns, 1 $\frac{1}{2}$  in. long.
- 28 Mc.—6 turns, 1 $\frac{1}{2}$  in. long.

L<sub>2</sub>—Barker and Williamson TL series with center links.

- Substitute coils may be wound as follows:
- 3.5 Mc.—36 turns, 2 $\frac{1}{2}$ -in. diam., 4 in. long.
- 7 Mc.—18 turns, 2 $\frac{1}{2}$ -in. diam., 4 in. long.
- 14 Mc.—10 turns, 2 $\frac{1}{2}$ -in. diam., 3 in. long.
- 28 Mc.—6 turns, 2 $\frac{1}{2}$ -in. diam., 3 in. long.

SW—Mallory 2-gang, 6 position switch.

Filament transformers—6.3v., 6a. to fit under chassis.



# ON THE ULTRA HIGHS



CONDUCTED BY E. P. TILTON,\* W1HDQ

**W**HAT is DX? To the low-frequency 'phone or c.w. man it is any section of the country remote from the part in which he lives. To the 20- and 40-meter men DX has to be something rare; mere miles are not enough. To the experimenter on the micro-waves, DX may be anything farther than he can shout. DX, then, is relative — anything which you, or the fellow in the next block, cannot work regularly, with comparative ease. Herein lies the basic appeal of u.h.f. operation — the ever-changing DX horizon.

Yet, when we stop to think of it, has not this craving for DX been slightly overemphasized in recent months? Surely the habit of combing the band for a sign of something beyond the normal range of operation and giving up for the evening when DX is not in prospect is responsible, in a large measure, for the low state of activity which falls like a blight on the five-meter band about this time each year. The habit of careful listening is one to be commended at any time, but when activity is at a low ebb, as it is in many sections of the country at this time of year, a little more transmitting and a willingness to chat with local stations may be worth a try, too.

Recently a number of dyed-in-the-wool u.h.f. men have expressed concern at the state of things on the five-meter band. However we regard our stretch between 56 and 60 Mc. we cannot disregard the desirability of these frequencies from a commercial standpoint. In the past year television and frequency-modulated broadcasting have been making rapid strides toward popular favor. Anyone who has listened to reception of frequency-modulated broadcasting cannot help but be impressed with the tremendous possibilities being opened up by this development in the field of real high-fidelity entertainment. While there is probably no immediate danger of our losing any of our u.h.f. allocations, those of us who get an occasional look at the commercial side of the u.h.f. picture are forced to the conclusion that it is high time that our logs showed consistent and complete occupancy of our 56-Mc. band as a bulwark against commercial expansion in the future. Need we say more!

As we approach the end of 1939 we might do well to take a quick look over the year now ending and see what it has brought us in the way of progress "on the ultra-highs." 1939 will stand out in our memories as the year when stabilization

\* 329 Central St., Springfield, Mass.

began in earnest on 56 Mc. Though the changes necessary to conform to the new regs represented too great a financial or technical hurdle for a small percentage of our 5-meter population, we feel sure that no serious-minded u.h.f. enthusiasts would ever want to go back to former conditions. Relieved forever of the burden of maintaining broad tuning as the principal feature of our receivers, at the expense of other more desirable characteristics, the performance of 5-meter stations went up almost immediately. The super-regenerative receiver, heretofore a useful (if not entirely necessary) adjunct to u.h.f. operation, disappeared almost completely, except for portable use, and its broad tuning, noisy operation, and relatively low sensitivity were little mourned. This one change did more than anything else to put operation on 56 Mc. on a par with the technique applied on the lower frequencies. The advanced 56-Mc. man can now hold his head high in any company!

Looking back over 1939 we find that, in general, 56-Mc. conditions have not been quite so favorable, particularly for skip of the 400- to 800-mile variety, as in 1938. Skip has been longer, a large percentage of work being over 900- to 1200-mile paths. There were fewer nights when signals poured in with the unbelievable strengths encountered in the early summer sessions of 1938. The thrill of QSO's over skip paths having faded just a trifle, operators began, this summer, to make lasting friendships with men in other sections of the country; taking more interest in tests on antennas and other equipment and engaging in leisurely rag-chews, rather than in marathon QSO contests.

The hero of the summer's activities was, of course, "Vince" Dawson, W9ZJB, of Kansas City, Mo., who joined the select circle of 56-Mc. immortals by completing the first 56-Mc. "Grand Slam." We offer as an example of how news, even of the u.h.f. variety, can travel: the fact that, within three days after W9ZJB's historic QSO with W7GBI on August 18th, there was scarcely a single u.h.f. man in the entire country who had not heard of this splendid accomplishment. Our hats are off to you, Vince, and to 7GBI, also. It must take plenty of perseverance to stay with 56 Mc. in a place like Great Falls, Montana!

Records were made and broken in rapid succession. The totals of "states worked" went up by leaps and bounds. Incidentally we'd like some up-to-date dope as to who is really leading in this department. How about your records, gang?





The climax of the u.h.f. DX season came on August 18th. Need we relate what the combination of 120 watts to T-20's, a Sky rider 5-10, a rotary-H array, and some snappy operating by Vince Dawson, W9ZJB, accomplished on this date?

An example of the possibilities of "5" when it is really hot is shown by the work of Bob Elmer, W3BZJ, Glenside, Pa., in working seven call areas (1-2-3-4-5-6-9) in the season's best opening, July 27th.

Not only was 1939 a big year for skip thrills, but the considerable strides in receiver development, both homemade and commercial, and the trend to higher power and higher efficiency in transmitters, added considerably to our effectiveness in continuous-path work. In fact, to many operators, particularly those fortunately situated as to location, this represents a much more interesting problem than skip-DX work. Reliable operation over a continuous path well beyond the visual is surely a much better demonstration of efficiency than knocking off a list of stations during a session of skip; and, as such, it is an excellent opportunity for much worth-while work. For a better understanding of the problems involved we heartily recommend a thorough study of the work of the late Ross Hull who started it all back in 1934.\*

The improvement in effectiveness resulting from the general use of high-grade receivers permits a very interesting study of weather conditions and their relationship to u.h.f. conditions, inasmuch as small variations in signal strength are more noticeable and easily measured. With a working knowledge of the factors involved in lower-atmospheric refraction, this sort of DX can be predicted in advance with considerable accuracy. In general it appears that continuous-path DX occurs most frequently in the late spring and early fall. At these periods the days are apt to be quite warm and the nights cool, with temperature inversions occurring most frequently and over widest areas.

A high spot in the year's activities on the East Coast was the night of June 2d, when the entire Atlantic Seaboard was treated to an exhibition

\* Important dope in June '35 and May '37 QST.

of lower-atmospheric refraction seldom equaled in 56 Mc. history. On this occasion several stations in the southern part of the third call area (W3HJT, HDC, DBC, RL, CGV, WA, HI, and others) worked up into the New York area and into the first call area with comparative ease, several contacts in excess of 300 miles being recorded, with no skip involved. An unusual feature of this evening was the report of reception of a number of W2's and W3's by W5AJG of Dallas, Texas — an unusual combination of skip and extended local work. Outstandingly consistent performers in the field of reliable coverage over wide areas are W3DBC, Washington, D. C.; W2MO, Livingston, N. J.; W3BZJ, Glenside, Pa.; W2AMJ, Bergenfield, N. J.; W1KTF, Stamford, Conn.; W1KLJ, Fall Mt., Bristol, Conn.; W1DEI, Natick, Mass., and countless others.

The present known record for DX which is definitely known to be of the continuous-path variety is held by W8CIR, Aliquippa, Pa., who worked W1KLJ and W1HDQ on Sept. 14th and was heard in Hartford by W1LLL and by W1DEI in Natick, Mass., a distance of about 450 miles! The range of effectiveness in local work seems to vary markedly in different sections of the country. More observations and records along this line are needed. How about it, fellows? Let us hear about conditions in your locality.

Of international interest we note that considerable activity on 56 Mc. has been brewing in the Union of South Africa. A number of ZS stations who regularly operate on 28-Mc. 'phone have been carrying on tests on 56 Mc. with Americans who operate on both bands. W3HOH of Berneardsville, N. J., has been active in arranging these tests which have consisted of alternate 15-minute transmitting and listening periods each Saturday and Sunday morning. The ZS gang have been hearing various commercial services which operate slightly lower in frequency than the five-meter band, but it is not known if any American 56-Mc. station has ever been heard over there. That a ZS-W QSO on 56 Mc. is within the realm of possibility is indicated by a report of reception of the 56-Mc. sigs of ZS1AX by W8RLT of Detroit, Mich., on schedule on June 11th at 9:35 A.M. E.S.T.

The first England-Netherlands QSO on 56 Mc. occurred on August 17th, at about 10:30 P.M., when PAØPN and G2AO made contact on i.c.w. International work on 56 Mc. is not a new thing in the smaller European countries. The first PA-ON contact was made in 1937 and PA's have been heard in England before. PAØPN used 50 watts input and a vertical Zepp about 50 feet above ground. The distance is of the order of 250 miles.

We cannot leave a summary of the year's accomplishments without mention of the outstanding work of W3AC/3 with his 50-watt mobile rig and collapsible rotary from his pet

location atop High Point, in the northwest corner of New Jersey. Goyn's work in the A.R.R.L. F.D. and the U.H.F. Contest are now history, and what history!

#### 112 MC.:

**T**HE S.C.M. reports received at Headquarters recently are full of references to work on  $2\frac{1}{2}$ . The brief time available for getting together copy for our first u.h.f. column has not permitted running down any of these by the correspondence method; however, all reports of this sort will be investigated if full details are not immediately available, in order that a true picture of u.h.f. progress may be presented monthly. As all  $2\frac{1}{2}$ - and  $1\frac{1}{4}$ -meter work is, as far as we know, of a short-path nature, there is little possibility of our obtaining the whole interesting story of what is going on in the various sections of the country unless you fellows who are active report your accomplishments. More dope on the types of rigs in use, the antennas found most desirable, the reliable operating range obtained, and the extent of local activity are most earnestly requested.

The big news in 112-Mc. DX is, again, the work of Bob Swanlund, W9WYX, and Al Suedekum, W9VTK. Not satisfied with their accomplishments reported in the November issue (120-mile contact on Aug. 13th) they decided to see what could be done from Pike's Peak. On October 8th, braving freezing temperatures and a sleet storm which made it necessary to chisel the ice from his 6-element Yagi beam, W9WYX set up his 75-watt rig (details in article referred to above) and established contact at 2:05 p.m. with W9VTK, who was located on a small hill about 12 miles south of Cheyenne, Wyoming, a distance of approximately 150 miles airline! The rig used by W9VTK was a 6A6 oscillator with 6N7 Class-B modulator. The power input, 18 watts, was supplied by a pair of Vibrapacks. With these outstanding DX records, Bob and Al certainly must have stirred up plenty of interest in  $2\frac{1}{2}$  meters in and around Denver.

The simplicity of the equipment required makes this band ideal for the beginner; and for anyone who likes to experiment with antennas and simple rigs, 112 Mc. is fruitful territory. As indicated above, it is great stuff for the portable enthusiast; and for hidden-transmitter hunts it is ideal. Activity reminiscent of early five-meter days is going on in Boston, Fall River, Providence, and other large New England cities. WISS, Arlington, Mass., reports plenty of activity in the Boston area nightly, with up to 25 miles being worked regularly with simple oscillators using receiving tubes. Some of the W1's active in Eastern New England are HJB, JP, JUN, BOO, DPP, DEK, FIK, MDV, LIO, FBX, LEM, LDD, MGH, KVB/1, and many others. HJB and JP report many illicit stations in operation and this, as in early days on 56 Mc.,

represents a tough problem. Some discussion of what should be done about the u.h.f. "BL" is in order. Work on 112 Mc. seems to be confined almost entirely to modulated oscillators, though this need not be considered inevitable, as pointed out elsewhere in the column.

As to the antennas most suited to 112-Mc. use, WISS reports a predominance of the "Q" type. Our own meager experience with  $2\frac{1}{2}$  indicates that this preference is well founded. Surely, with r.f. losses being what they are at this frequency, some sort of untuned line is to be preferred when a feeder of any length is required and the "Q" seems to be the simplest and most efficient solution. Very interesting results can be obtained with close-spaced beams, what with the small dimensions required and the ease of providing methods of adjustment.

#### 224 MC.:

**G**EORGE BAILEY, W1KH (A.R.R.L. V.P.), reports plenty of business being done on  $1\frac{1}{4}$  in the Boston area. Several of the gang are using the Western Electric "doorknob," which will supply 8 watts output at 224 Mc. with ease. In addition to a 316-A, KH also has a pair of RK-32's at 300 watts. We hope to present the details of this rig and others, soon. George reports the best antenna yet tried consists of a 25-inch vertical rod fed with a 2-inch-spaced pair of No. 10 wires fanned out at the point of attachment to form a 6" equilateral triangle. Eighteen miles is covered consistently in a sked with W1HSV. Others reported active on 224 Mc. are BZR, CCX, and BJB. George offers a word of caution to those tempted to use r.f. meters in making adjustments at 224 Mc.: "Don't!" R.f. at this frequency just doesn't agree with meters now available, he relates.

#### U.H.F. "KINK OF THE MONTH":

**W**ANT to try  $2\frac{1}{2}$ ? You don't have to modulate an oscillator to do it. Many of the newer triode transmitting tubes will perform surprisingly well as doublers from the regular five-meter exciter unit. W1HDF, Elmwood, Conn., is running an HK-54 doubler, driven by an 807 running straight-through on five. This 807 normally drives a pair of 54's on 56,088 kc. The single 54 has been operated at 100 watts, plate-modulated, and it surely sounds FB on 112,176 kc.!

Other tubes known to work well in conventional doubler circuits are HK-24, TZ-40, and 35T. The layout is even simpler than the average oscillator. At W1HDDQ, we have used a TZ-40 with nothing in the plate circuit but a "hairpin" made of No. 8 wire having a total length of about 8 inches. The hairpin can be squeezed together or spread apart to attain minimum plate current. The grid is link-coupled to an 807 doubler from

(Continued on page 82)

# The "Portable Five"

**A Midget Transmitter with 5 Watts Output**

**BY FRED SUTTER,\* W8QBW-QDK**

**T**HIS story may surprise or even disappoint those who have followed the adventures of our little hero, the 6L6G tube whom we left in the September issue putting out sixty watts. It is, perhaps, anti-climax to describe now a midget transmitter with five watts output, but there may be another kind of surprise when the story is read.

No claims as to originality are made for this little job. W2GCV, in the June, 1937, issue suggested the idea and W9IGF expanded it into a Tri-tet in the June, 1939, issue. And now along comes ole 8QBW painting the lily (to coin a phrase). All that I can offer is that this adaptation is very small, very light and very well enclosed against mechanical derangement, so that it is really a portable transmitter. That word "portable" has been much overworked, definitely. If you do your "porting" in a truck or an automobile, then a lawn-mower or a St. Bernard are portable, I suppose. But let us see what can be done about it.

The "Portable Five" has the whole works, transmitter and power supply, on a chassis only 3 by 3½ by 2¾ inches, and the weight is one pound and ten ounces. The output is a little better than 5 watts. The cost, exclusive of crystal, is \$6.43. It can be tucked into a corner of the suitcase without taking up room or adding weight to amount to anything.

I can already hear a snort from Dan to Denver, "Who wants to bother with five watts, anyhow?" Well, that is what I thought myself, but you never can tell till you try, so the little job was put on the air and some surprises were immediately uncorked! At W8QDK, on 40 meters, the first 36 tries resulted in 21 QSO's, or 60%. A couple of these were ended by QRM, but this is nothing unusual, so we won't worry. These contacts ranged from Massachusetts, New York, New Jersey, Pennsylvania, Michigan, Ohio, Virginia, Wisconsin and Indiana. They averaged about RST 579x. This was in July, by no means a favorable period. Nine of them were local, *i.e.*,

\* 1000 Kensington Road, Grosse Pointe Park, Mich.

within the State of Michigan. At W8QBW operation was confined to the 80-meter band and the first 33 tries resulted in 21 QSO's or 64%. These ranged from Michigan, Ohio, Illinois, South Carolina, Pennsylvania, New York and New Jersey. It may as well go into the record that the antennas here are pretty good: 80-meter half-wave Zepps about 40 feet up and well in the clear. It is still true that a dime in the antenna is worth a dollar in the transmitter, and although I won't vouch for the exact accuracy of this formula, there is the idea, anyway. Fortunately a good antenna involves little more outlay than a makeshift wire. Careful planning and "arm-strong" tactics which cost nothing making the difference. Just what this rig will do when the frost is on the pumpkin remains to be seen.

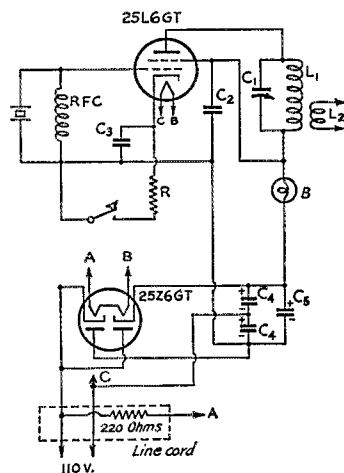

Fig 1 — The "Portable Five" Circuit Diagram.

- C<sub>1</sub> — 100-μfd. midget variable (Hammarlund MC-100-S).
- C<sub>2</sub>, C<sub>3</sub> — 0.01-μfd. paper, 600-volt.
- C<sub>4</sub>-C<sub>4</sub> — Dual-3-μfd. electrolytic (Cornell-Dubilier KR-238).
- C<sub>5</sub> — 10-μfd. electrolytic, 300-volt (Mallory type BB).
- L<sub>1</sub>, L<sub>2</sub> — See text.
- R — 200 ohms, 10-watt (Ohmite Brown Devil).
- RFC — Receiver-type choke.
- B — Pilot bulb, No. 40 tan bead.

In filament circuit, connect similarly-lettered points. Chassis is not connected electrically to any part of the circuit.

NOTE. — The key is not at ground potential in this circuit, and although the voltage between key leads and ground is not dangerous, care should be taken to avoid touching metal parts of the key.

No "QSL" this time — this outfit's too small to cover a postcard! But QBW has been having a lot of fun with it — and we have a hunch a lot of others are going to do likewise

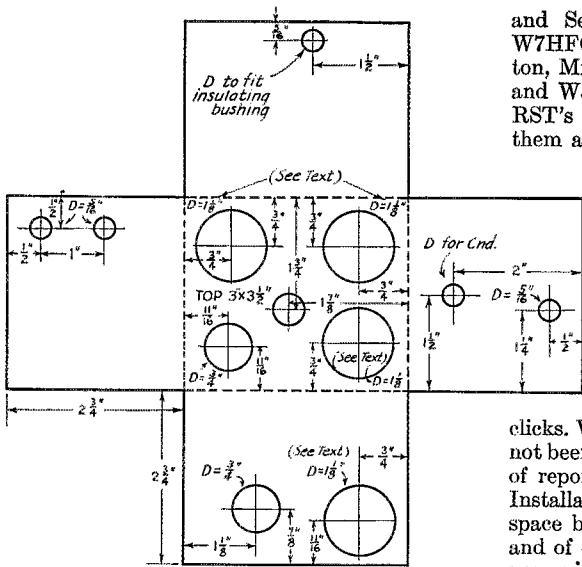

Fig. 2 — Chassis template for the "Portable Five."

It will, with suitable crystals, work on 80, 40 and 20 meters. But I would not bother with 20 meters, for those chaps won't pay much attention to W's. If you have a 20-meter crystal you can give it a whirl, of course, but I would not advise investing in one just for the purpose of using it in the "Portable Five." Abner, take notice!

(NOTE. — That bit of advice was written before war restrictions had clamped down on nearly all DX. At present the DX addicts are forced to fall back on W QSO's or keep still — and you know a ham just can't keep still. So at present you can indulge in plenty of activity on 20. As an indication of what may be done, *at present*, here is the log of WSQBW for September 28, 1939 on 20 meters (14,300 kc.) using the "Portable Five":

11:53 A.M.	W1LYL	Boston, Mass.	.....	RST	569x
1:10 P.M.	W4MR	Greensboro, N. C.	.....		599x
3:35 "	W4FLP	Franklin, Tenn.	.....		589x
6:04 "	W2HEM	Long Island, N. Y.	.....		589x
8:07 "	W9QWA	Hastings, Neb.	.....		589x
8:50 "	W5DNW	Lafayette, La.	.....		589x

On that date there were five failures so the measure of success was 54%. On September 25

and September 26th the best contacts were W7HFG, Sheridan, Wyo., 569x; W9CJZ, Balaton, Minn., 589x; W1KQZ, Boston, Mass., 579x; and W5BVM, Dallas, Texas, 589x. All of those RST's are correct and I hope the printer gets them as I have written them. This looks to me like nice work for a transmitter with only five watts output. One fellow said, "This QSO has opened my eyes to the possibilities of low power." And it opened mine also!

The crystal current is so low that it will not light to visibility a 60-ma. pilot bulb. The photograph shows this crystal bulb but later it was taken out. You don't need it. The signal is a nice d.c. note with no noticeable ripple, chirp or clicks. When first put on the air, condenser  $C_5$  had not been installed and although all except a couple of reports were 9x, a little ripple was apparent. Installation of  $C_5$  fixed that. There is little waste space but all parts go in nicely without hitting and of course the leads are very short — almost non-existent.

### General Construction

The crystal oscillator is a 25L6GT and the rectifier a 25Z6GT. The filaments of these tubes are in series and use up 50 volts, the remaining volts being absorbed by the 220-ohm cord. The circuit is that of the "QSL," "Economy" and "Runt"<sup>1</sup> transmitters except that screen condenser  $C_3$  (in their diagrams) is omitted. Looking at the photograph, on the left apron are the feed-throughs for the antenna leads; in front are the plate condenser knob, the crystal and its pilot bulb (but you may as well omit it). On the right is the feed-through for one keying lead, the resistor cord entering at this side. On the top is the 8-8- $\mu$ fd. condenser and the rectifier tube, back of which are the coil and oscillator tube. The plate current pilot bulb is in the center. Contrary to usual practice, the ground leads do not run to the chassis but are all brought to an insulated (6-32) stud on the rear apron. This keeps the chassis at zero potential. The second keying lead goes to this stud.

(Continued on page 84)

<sup>1</sup> Sutter, "The 'Runt Sixty' and the 'QSL Sixty.'" *QST*, September, 1939.

Everything's here but the antenna and key! The "Portable Five" is only a handful, but it gets around.

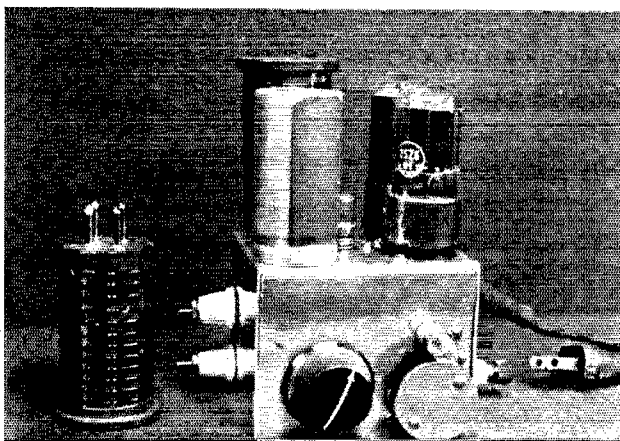

# A.R.R.L. Copying Bee — December 8th

**A**S IN the previous Bees, some unusual character and figure combinations and plain language groups will be sent in no particular sequence. The League will return all papers (except winners) with a *confidential rating*. A copy of the transmitted texts will go to each participant. Transmissions will all be 60 words in length. The sending will be by tape at about 25 words per minute. It will be a test to *copy what you hear*. Did you ever wonder, "How well *can* I copy?" Here's the chance to find out!

To COPY code accurately is the special mark of technique that distinguishes the real amateur. This is the annual opportunity to note our progress above the mere license requirement. The winner or *as many as submit perfect copies* will receive a striking bronze medallion award from A.R.R.L.

The following stations, all using "automatic" equipment, have been selected in the different time zones. Care will be taken to make all messages equally difficult by different words, word order, errors, etc. We urge everybody who knows the code *at all* to take part. Send in *whatever you get*, however little that may be. Check on your proficiency and have some good fun too.

All participants will be mentioned in *QST*. The schedule of transmissions for Friday night, December 8th, is shown below:

The rules for taking part in the copying bee:

(1) Any amateur operator, not having access to the tape or transmission copies, and copying wholly by ear, is eligible.

(2) Mark one copy as your "best"; only this one copy shall count, but report all the above stations that you can hear to us. Keep copies other than your "best" to check yourself when we mail out the official texts to you.

(3) Print your name, call signal and address plainly on each entry.

(4) Send in *original* copies. Re-copying messages *invariably* introduces errors and detracts from credits.

(5) Copies must be mailed bearing a postmark in the year 1939 to be counted. Mail at once or within five days to make sure.

(6) Every contestant must certify he has not been employed as a commercial or government radio, Morse or cable operator in the last year. This is strictly an amateur contest. The following exceptions, however, shall be eligible:

(a) Holders of commercial licenses without experience under same. (b) Such holders (phone licensees or technical attendants) whose duties have not been telegraph operating within one year.

The transmitting stations will each send V's ten minutes before scheduled times below. All amateurs are requested to note the frequencies listed and try to cooperate by keeping silence on these channels during copying bee transmissions. Write down *just what you hear*. Send in all you get so you receive credit and we can send you the official texts for examination.

— F. E. H.

Station	Frequency	E.S.T.	C.S.T.	M.S.T.	P.S.T.
W1AW (W. Hartford)	1762/3825/7280/14,254/28,600 kc.	9:15 P.M.	3:15 P.M.	7:15 P.M.	6:15 P.M.
W6AM (Long Beach)	28490 kc.	9:15 P.M.	3:15 P.M.	7:15 P.M.	6:15 P.M.
W2KEZ (New York)	7003 kc.	9:15 P.M.	3:15 P.M.	7:15 P.M.	6:15 P.M.
W2KEZ (New York)	3510 kc.	10:15 P.M.	9:15 P.M.	8:15 P.M.	7:15 P.M.
W6AM (Long Beach)	14,306 kc.	10:15 P.M.	9:15 P.M.	8:15 P.M.	7:15 P.M.
W9UZ (Chicago)	7003 kc.	10:15 P.M.	9:15 P.M.	8:15 P.M.	7:15 P.M.
W9BAZ (Louisville)	3670 kc.	10:15 P.M.	9:15 P.M.	8:15 P.M.	7:15 P.M.
W6AM (Long Beach)	7264 kc.	11:15 P.M.	10:15 P.M.	9:15 P.M.	8:15 P.M.
W9BAZ (Louisville)	1776 kc.	11:15 P.M.	10:15 P.M.	9:15 P.M.	8:15 P.M.
W6CIS (W6ZF) (San Francisco)	3501 kc.	11:15 P.M.	10:15 P.M.	9:15 P.M.	8:15 P.M.
W9UZ (Chicago)	14,006 kc.	11:15 P.M.	10:15 P.M.	9:15 P.M.	8:15 P.M.
W6AM (Long Beach)	3632 kc.	12:15 A.M. (9th)	11:15 P.M.	10:15 P.M.	9:15 P.M.
W6CIS (W6ZF) (San Francisco)	7280 kc.	12:15 A.M. (9th)	11:15 P.M.	10:15 P.M.	9:15 P.M.
W1AW (W. Hartford)	1762/3825/7280/14,254/28,600 kc.	12:15 A.M. (9th)	11:15 P.M.	10:15 P.M.	9:15 P.M.
W6AM (Long Beach)	1962 kc.	1:15 A.M. (9th)	12:15 A.M. (9th)	11:15 P.M.	10:15 P.M.

# 1939 Field Day Tops Them All!

BY E. L. BATTEY,\* WIUE

**T**HE will of radio amateurs to prepare for emergency operation was convincingly demonstrated in A.R.R.L.'s Seventh Annual Field Day, June 1939, when 1718 individuals participated in the tests of auxiliary station equipment. This represents the greatest number of United States and Canadian amateurs ever to take part in any single contest activity!! 128 amateur radio clubs had a total of 1269 participants, while 449 individuals participated as members of 119 additional groups. The Field Day has now taken its place as amateur radio's No. 1 operating activity — and rightfully so, since "emergency preparedness" is foremost in the plans of all conscientious amateurs.

Our sincere thanks to the club secretaries and other individuals who sent us the scores of interesting and complete reports, and photos. The stories told would entirely fill an issue of *QST* — and would make mighty interesting reading, too — but we are able to present only a cross-section of the many accounts sent in. There were the usual tales of inclement weather, equipment difficulties, etc. — but in spite of the "grief," a grand time was reported by all.

The scores rolled up in the '39 F.D. smashed all previous records to "smithereens." The leading station worked 161 "portables." While the previous high score was 3708, this year *eleven* groups scored over 3000 points, twenty-seven over 2000, five over 4000, and one over 5000!! These scores spell "success" for the F.D., but the real success for every group, whether its score is large or small, is the testing of portable-emergency gear, the actual purpose of the Field Day. Long may the F.D. spirit continue — and grow!!

The ace Field Day crew, the Egyptian Radio Club, W9AIU/9, again led the way (for the third consecutive year), establishing an all-time F.D. high of 5508 points . . . 438 stations worked (161 portables). 87.5% of all contacts were by c.w. The E.R.C. group consisted of 18 licensed amateurs and one ham-to-be, who assumed the important duties of "chief logsman." Nine complete units were used on six amateur bands, 56 through 1.75 Mcs.; 82% of the total contacts were made by the four leading operators (W9KEH, W9RCQ, W9EKY, W9EFC), and 60% of the total contacts were made by the two leading operators (W9KEH, W9RCQ). Transmitters used were as follows: 56 Mc. — 6J5-807-HK54; 23 Mc. — 6J5-807; 14 Mc. — 6A6-802, 6A6-807; 'phone, 807 final, modulated by 6N7 Class B; 7 Mc. — two crystal oscillators each using an 802; 3.5 Mc. — 802 osc.; 804 osc.;

\*Assistant Communications Mgr.

'phone, 807 final, 6N7 mod.; 1.75 Mc. 'phone — 6C5-6L6, 6L6 mod. Receivers were two Halli-crafter 5-10's, seven NC101X's, and HRO and an RME69. Six 40-foot inverted Y masts and one 10-foot pole on the farm house location supported the nine antennas. The six collapsible masts are part of the regular W9AIU emergency equipment; 500 feet of guy wire was employed. The regular club emergency generators, mounted on a four-wheel trailer, supplied the juice; 23 gallons of gasoline, 2 quarts of oil were consumed by the engines. The Egyptian Radio Club deserves a big hand for its splendid showing. Give, gang! But watch out for 'em in 1940 — they will be aiming at 600 contacts!!

A healthy second was the Jersey Shore Amateur Radio Association, operating W2AER/2 — 4437 points for 313 contacts (139 portables). This group of 17 operators and 2 food experts kept seven transmitters and receivers in operation most of the 26-hour period. The 56-Mc. rig operated from the top of an abandoned tower; the other rigs were set up in three tents. The seven separate antennas were held up by six 30-foot portable masts and the top of the tower. Power was obtained from a 300-watt and a 2½-kw. generators, both gasoline motor-driven.

The W2AER/2 gang had a side wager with the Bridgeport Amateur Radio Association, winning same by a slight margin. The B.A.R.A. outfit, using the club call W1JHT/1, placed third with a score of 4338 — 283 contacts (175 portables). The fifteen licensed amateurs making up the Bridgeport group manned five complete units on as many bands. All power was furnished by a Homelite 1.5-kw. generator. Location was Red Woods Cabins, Bethel, Conn. It should be noted

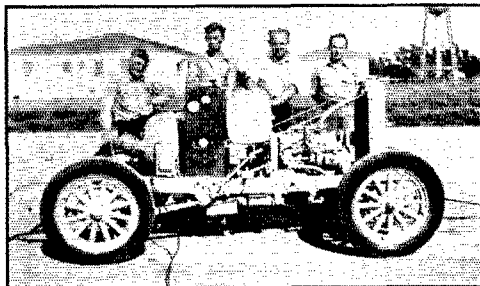

5-kw.!

This 5-kw. power unit, the property of W6DPT, was used in the Field Day by the Bell Radio Club. Operators of the club station, W6HXP/6, included (l. to r.) A. F. Burke, W6DPT, E. C. Mecllin, W6NGQ, F. W. Glass, W6MVL, and H. N. Tizor, W6RCH.

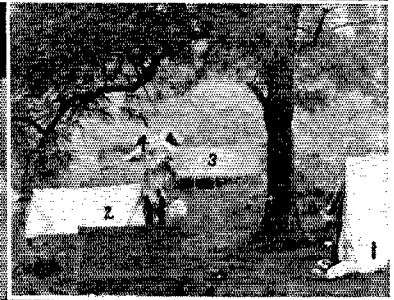
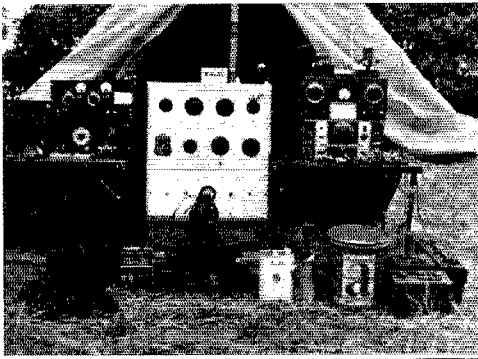

**SOME  
TYPICAL**



**FIELD-DAY  
SETUPS**





*Upper left:* It takes plenty of gear to make up a complete club Field Day set-up! The Philadelphia Wireless Association had all the essentials, as will be noted in this shot of the equipment used at W3GAG/3. *Upper right:* W6BGY/6, Unit No. 1 of the Society of Amateur Radio Operators, Inc. Operators are on the job at the 1.75-, 7- and 14-Mc. rigs. At the right is the 3.5-Mc. c.w. outfit. *Upper center, left:* The second highest F.D. scorers, Jersey Shore Amateur Radio Association, W2AER/2, located near the northern point of Sandy Hook, N. J. Four of the six 30-foot portable masts and the 3.5-Mc. tent are shown here. The abandoned 80-foot tower, used by the 56-Mc. crew, and the other tents were at the foot of the sand dunes, back of the photographer. *Center:* One of the ten portable 45-foot bamboo masts (7½ lbs. each), which are part of the regular Field Day equipment of the W9V SX/9 group. *Upper center, right:* W8ODJ/8 location, Buckeye Short Wave Radio Association. (1) 3.5-Mc. c.w. tent and hq.; 1 rig; (2) 3.9- and 56-Mc. 'phone tent; 2 rigs; (3) 7-Mc. c.w. and 1.75-Mc. 'phone tent; 2 rigs; (4) 14- and 28-Mc. c.w. and 'phone tent; 1 rig. Other tents were used for "sleeping and eating."

that B.A.R.A. came up from fifteenth place in the '38 F.D. to place third in '39. That gang means business!

The contest-minded Frankford Radio Club is found up with the leaders as usual. Using the call W3BES/3, F.R.C. this year scored 4212 (304 contacts, 139 portables); 21 licensed amateurs were on the job, using several rigs on 3.5, 7 and 14 Mcs.

Fifth high and also in the "4000" class was the York Radio Club operating W9TGB/9 at White Pines State Park, Oregon, Ill. This group of sixteen operators knocked off 282 contacts with five units, one each on 1.75, 3.5 and 14 Mcs., and two on 7 Mc. All units except one of the 7-Mc. set-ups were housed in a large four-room log cabin. The c.w. rigs all used e.c.o.

Forging ahead in F.D. activity is the Dells Region Radio Club, whose station W9RBI/9 scored 3942 this year (328 QSO's, 95 portables). Five complete units were operated by the seventeen participants. Bands used were 1.75-, 3.9- and 14-Mc. 'phone and 3.5-, 7- and 14-Mc. c.w.

In the above-3000-points group we also find the Tri-County Radio Association, Inc., W2GW/3, 3762; Buckeye Short Wave Radio Association, W8ODJ/8, 3636; Motor City Radio Club, W8MRM/8, 3312; Tri States Radio Club, W3GKI/2, 3078; and South Cleveland Radio Club, W8ICS/8, 3024. Leading the non-club groups was the W9V SX/9 gang of seventeen with 2952 points, followed by three operators at W8QAN/8 with 2439, and a group of twenty at W8BQ/8 with 2403.

The veteran Hamilton Amateur Radio Club, VE3KM, led the Canadian participants with the tidy score of 2335 (184 contacts, 105 portables).

Scoring was the same as in '38. Sufficient care was not taken by many participants to send their F.D. messages in proper form, or to submit copies with their logs. Failure to submit copies was called to the attention of all delinquents, and we

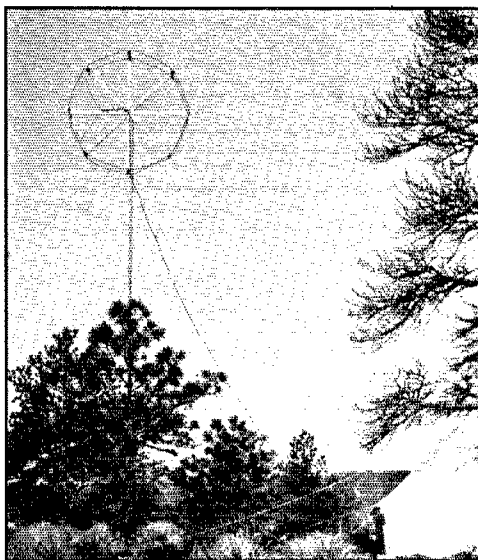

*W9ADJ/9 Squirrel Cage*

The antenna used by the Black Hills Amateur Radio Club on 28-Mc. 'phone was a Reinartz "squirrel cage" rotary. It sure looks handsome, standing there in the wilderness!

are leaning over backward to give some credit very generously in every case the originator sent us the message copy. Our announcement justifies us in taking off the full 25 points, not only for not sending a copy of message with handling data as sent for credits, but for incorrect checking of same. Full credit for messages reported is subject to a deduction of 10 of the 25 points for incorrect checks. Where message copies were not submitted the whole 25 points were deducted. Messages properly handled and reported are an important part of the Field Day, since actual emergency

*Lower center, left:* The Bridgeport Amateur Radio Association, W1JHT/1, was third high in the '39 F.D. Seven of the group of fifteen operators are shown with the 1.5-kw. Homelite generator, which was loaned to the club for the tests. *Lower center, right:* The Valley Key and Mike Club of Sharon, Pa., operated W8OAJ/8 at Masury, Ohio. Seated outside the tent are H. M. Falkner, W8BVP, Henry Saborsky, W81YQ, and Pete Antolich, W8OAJ. At the operating position are P. V. Trice, W8QHS, and S. A. Peterson, W8SFG. *Lower left:* Unit No. 2 at W3AIR/3, Trenton Radio Society. Watching the progress of the operators are A. G. Wentzel, W3HW, Harry S. White, W3CFB, and Frank V. Cantwell, W3FNN. Elmer J. Middleton, W3GFQ, and Wm. H. West, W3GHK, are at the controls. Equipment includes (l. to r.) 6L6-6L6 transmitter, crystals, tubes and antenna ammeter, transmitter power supply, HRO receiver, frequency meter-monitor, 100-kc. oscillator, power supply, receiver coils. *Lower right:* This group of seventeen members of the Hamfesters Radio Club, Inc., made a top-notch showing at W9V SX/9. Special gray uniforms, each with "Hamfesters Emergency Corps" on the back and the operator's call over the shirt pocket, were provided for all.

operation would call for intelligent message handling.

It was a great Field Day! If what we have already reported has not convinced you, we know you will agree after reading the comments of some of the participants, which follow this portion of the report. Plan NOW for the 1940 F.D.

### Comments from Contestants

Five operating positions were in use, two in the farmhouse and two in a "playhouse" some 30 feet away. The fifth position was located across the road in a car, utilizing a kite antenna. A Vee antenna 400 feet on a side was erected in advance, supported on "A" frames 35 feet high. A 3.5-Mc. half wave, a 1.75-Mc. full wave, and a 7-Mc. half wave were also prepared before hand. With 1100 more feet of wire in the kite antenna, we were well equipped with skywire. The advance preparation and the excellent antenna system paid dividends, as a report under S7 was a rarity despite the low power. Five HRO receivers were used operating with 6-volt tubes and 135 volts of B battery on the plate. The heaters were, of course, storage battery-operated. — *Tri-County Radio Association, Inc., W6GW/S.*

Operation was from the same location as in recent years, and the same call, VE3KM, was used. This QTH is approximately three miles east of Waterdown, Ont., about nine miles from Hamilton. Since last year a permanent shack has been built, designed to hold four operators and their equipment, but which proved to be capable of holding a dozen or more during the night, when it turned quite cool. Amateurs always did overload everything possible! For the first time in recent years it didn't rain, so that a roof over our heads was not a real necessity, but it was an added comfort. — *Hamilton Amateur Radio Club, VE3KM.*

The *Tri-States Radio Club* gang journeyed to Montclair, N. J., with 30 storage batteries, 14 operators and much apparatus. Equipment was installed in cars parked along the ridge overlooking Montclair, with the exception of the 3.5-Mc. rig, which was installed beneath a beach umbrella under a convenient tree. Much credit should go to Wilson Norwood, W2IQQ, for his untiring efforts and able assistance in making this Field Day the best ever for us. — *W3GKI/S.*

The *South Cleveland Radio Club* set up at Hudson, Ohio. After the usual headaches were ironed out, we finally got on

the air and, except for a few generator breakdowns and the final amplifier falling out of the 7-Mc. rig, we stayed on for the duration of the contest. Conditions were fair — there was quite a bit of static Saturday night and early Sunday morning, but the only outfit seriously bothered by the QRN was 1.75 Mc. All in all we really enjoyed ourselves, although some of the fellows claim their wrists got sore, and we haven't heard W8ICS and W8OBG, the 1.75-Mc. boys, talk above a whisper for some time. HI. We're looking forward to a bigger and better Field Day next year. — *W8ICS/S.*

Feeling that Field Day is the Training School of Emergency Work, the W9VSX Field Day and Emergency Corps Group have acquired the necessary equipment that would be required in an emergency and in a form that can be easily transported. We have converted a Model T Ford into a 3-kw. power plant, and use a tow bar to take it from place to place. We expect to tear off the body and build a streamlined body so that we will have a place for everything, and everything in its place. We have two re-wound Dodge generators, powered by small ½-h.p. gas engines, that we call our emergency-emergency power supplies. Other equipment includes seven tents, four for operating positions, one for the cook, one for sleeping, one for lounge, and the "WPA Special"; ten 45-ft. bamboo masts (7½ lbs. each), cooking and sleeping equipment, six transmitters, two of which can be modulated and five receivers. All radio equipment is home-grown. This is one of the five A.E.C. groups composed of operators that are members of the *Hamfesters Radio Club, Inc.* We were not competing as a "club" group, however. Highlights of Field Day: The fact that 12 watts on 1.75-Mc. 'phone worked 9 states; W9MRQ causing a panic when he started to use his electric razor; thanks to the Model T, we had hot and cold running water at all times; good food and a swell time; 8640 feet of rope used to guy the masts, 496 feet of antenna wire, exclusive of feeders and receiving antennas; 850 feet of double a.c. line; 28 gallons of gas consumed by the Ford in 27 hours. The entire group wore gray covert uniforms, with "Hamfesters Emergency Corps" on the back, and their calls over the shirt pocket. All wore sun helmets. Our group made two columns on the front page of one of the local newspapers. — *W9VSX/S.*

We located near Zane Caverns, about three miles east of Ohio's highest point. Antenna was double Zepp, 270 feet long, and 133 foot single Zepp. From antenna location one can see horizon in north, east and south directions. Location proved ideal for both receiving and transmission, but 16 hours of contest was accomplished in hard rainfall of 2.76 inches. Biggest difficulty was in keeping tent up and apparatus dry. — *W8NAB/S.*

The *Greater Cleveland Emergency Planning Committee* operated from the local headquarters of the American Red Cross. They turned the building over to us on Saturday noon, and it provided a very interesting test of equipment and also gave an idea of the conditions and difficulties to be met there in emergency. The Red Cross headquarters is located on Euclid Ave. at East 35th St., one and ¼ miles from the Public Square on Cleveland's busiest thoroughfare, with plenty of street cars and automobiles going by every second. A Kato 500-watt gas-generator unit was used. The executive chairman, Mr. John D. Cremer, Jr., and Judge Stanley Orr, chairman of the Disaster Relief Committee, seemed to be very well impressed with the demonstration, and expressed the idea that they didn't think the hams could carry out the work in such a businesslike manner. We covered 14 states on this week-end. — *W8DS/S.*

Vee beams used on 7 and 14 Mc. Zepp on 3.5 Mc. and Marconi on 1.75 Mc. A fine contest this year and the Field Day is becoming more popular. — *W6NIK/S.*

Our c.w. tent housed two transmitters. The first was a 6K7 e.c.o. — 6L6 final running on 7 and 3.5 Mc. The other was a 6L6 crystal — 807 final running on 7 and 3.5 Mc. Two National 101X receivers were used. A 100-kc. oscillator was used for a frequency check on the e.c.o. Two 3.5-Mc. center-fed Zepp antennas were used for the transmitters. The 'phone tent housed an 89 crystal/e.c.o., HY61 transmitter and a t.r.f. super-regenerative receiver. The HY61 was plate-modulated with a pair of 6V6's in Class B. Two J antennas were used for transmitting and receiving. Several



### An Important Man is the Cook!

"In the galley" at W9AIU/9, Owen Griffiths, W9OWD, and Ben Ruyle, W9BLL, appear happy over the performance of Ed Stumpf, W9NKS, official chef at the Egyptian Radio Club camp. Ed dispensed 69 hamburgers, two cases of Coca-Cola, 15 plates of bacon and eggs, 18 bowls of cereal with cream, two cakes, numerous pots of coffee and 51 ham sandwiches! The E.R.C. gang gives much credit to the cook for success in the F.D. The inner-man *must* be served!

**1939 ARRL Field Day "Greetings"  
from the C. S. R. A. Gang**

Operators:—  
WOPNV WOHIV WQGIW  
WSPFQ WSDGK WDNNE  
W9K9K W9STF M. Gable, eng.

**W9PNV-9**

Portable in Schiller Park, Illinois

Report Q.....R.....S.....T.....

Tnx lot for QSO See you next year

Chicago Suburban Radio Association

**Field Day QSL**

Quite a number of participants sent special QSL cards to all stations worked during the F.D., adding a final fraternal touch to the affair. This is the card used by the S.C.R.A. gang.

large balloons were employed to suspend an antenna 300 feet in the air. A box kite was also included in our equipment. The greatest DX worked was ZL2MM, on 7 Mc. — *Northwestern Nassau Wireless Association, W9OQ.*

Members of the *Schenectady Amateur Radio Association* set up operations in the form of an emergency demonstration for drill and experience. The American Red Cross took a keen interest in our activities, and Mr. C. G. Marcy of the Disaster Preparedness Committee cooperated with us. The base of operations was located at a most favorable emergency location with respect to the community. We were located seven miles from the city on the Sacandaga road. At the Red Cross headquarters in the city, a 112-Mc. station was installed for communication to the field. Well in advance of the Field Day a meeting was held at the Emergency Coördinator's home to discuss plans. Seven antennas were installed and terminated to cover all amateur bands. During the contest there were four transmitters operating simultaneously in the 14-, 7-, 3.5- and 1.75-Mc. bands, besides the u.h.f. transmitter at Red Cross Headquarters. These transmitters were housed in three tents, and a separate tent was used to prepare food for the operators. One gas engine-driven generator of ½-kw. rating supplied power to all receivers. Another gas engine-driven generator of 1.5-kw. rating supplied power to the 14-, 7- and 3.5-Mc. transmitters and also light for the tents and flood light for the field. The 1.75-Mc. transmitter was powered by a separate gas engine. Members of our club, under the direction of Dr. A. F. Korn, president of S.A.R.A., and all A.E.C. members gave splendid cooperation during this demonstration and contest. The Assistant Emergency Coördinators did an excellent job of organization on their assigned bands, and we gained knowledge and enthusiasm for future contests and emergency preparation. — *W9ACB/S, Emergency Coördinator.*

This station was located at football field. Fifty-five-foot floodlight poles not at all in the way! — *W4RO/4.*

Used RME 69 and crystal 6L6 on 7 Mc., RME 70 and crystal 6L6 on 3.5 Mc., each transmitter running 20 watts input. Power supply was rebuilt self-excited Dodge gen. driven by one-h.p. Lauson engine. Both rigs were operated side by side on truck, with power 100 ft. away. First Field Day operation for the Bartonville gang, and we learned a few things that will come in handy for the next one or in case of emergency. — *W9ARN/9.*

For the first time in three years about 15 members of the *Northwest Amateur Radio Club*, Des Plaines, Ill., participated in the Field Day without having rain to dampen their spirits, clothes, equipment and food! The location was at Camp Reinberg, a Cook County Forest Preserve Welfare Camp, located about 30 miles northwest of Chicago. Transmitters with not more than 20-watts input were operated on all bands from 28 through 1.75 Mc. Both c.w. and 'phone were used. Power was supplied by three gasoline-driven a.c. generators, one 1 kw., two 300 watts. Excellent food was provided by our dependable cook, W9TLQ. The contest proved the club could be depended upon in the time of emergency, we believe. — *W9LIP/9.*

The *Austin Radio Club of Chicago* operated its stations near Lyons, Ill., in the Cantigny Woods of the Forest Preserves. Power was supplied by a 500-watt a.c. gas-driven generator that was wound and built by W9LTC. One of our stations was located in a Forest shelter, and the other in a tent about 75 feet away. Transmitters were (1), e.c.o. operating on 7 Mc. only, using a 6K7 osc. and a 6L6 amp. running 17 watts input; (2), 6L6 crystal, 809 amp., 6L6 mod. operating with 16 watts input on 1.75-Mc. 'phone; (3), a 6F6 crystal, 6L6 amp/dbler on 3.5 Mc. running 18 watts input. Receivers were a Hallicrafter SX15 and a SX16. Antennas — on 7 Mc., a 66-ft. center-fed Zepp — on 1.75 and 3.5 Mc., a 132-ft. end-fed zepp. All W districts were contacted, including VE2 and VE3; 178 contacts were made and 30 states worked with this low power! And a good time was had by all, even if the 17-year-old Locusts did push the noise level up to a good 87! Bring on the next Field Day. We are always ready! — *W9LTC/9.*

We were located on top of the 80-foot tower of the First Presbyterian Church, located here in Ft. Scott, Kans. We were up above most of the town, and I don't mind telling you it got plenty windy up there. Hi. — *W9QXG/9.*

All operation was carried on about one-half mile north of Sheboygan, Wis., along the Lake Michigan shore. Power for transmitters, receivers, lights, etc., was supplied by a Kohler 1500-watt, 110-volt a.c. generator, furnished by the Kohler Co. The four units were spaced equally around a circle with a radius of 100 ft., with the headquarters location in the center. Three of the stations were housed in tents and the fourth in a trailer. Power wires were raised above the ground, as this eliminated last traces of generator noise. After two years' experience in the F.D., we are really going to work with a vengeance next year. Those boys from East St. Louis (W9AIU) can be licked, and we hope to be the ones to do it. Among the things we believe are absolutely necessary for a high F.D. score are: Sufficient units to cover all 'phone and c.w. bands, absolute elimination of QRM between units, use of only experienced operators, with plenty of additional help for logging, etc., use of break-in operation, use of e.c.o.'s or plenty of crystals so bands can be thoroughly covered, an effective communication system between units to keep track of stations worked, and possibly the use of directive antennas. — *Sheboygan Radio Amateur's Club, W9YWX/9.*

The *Trenton Radio Society* was looking forward with great anxiety to the Field Day week-end. The apparatus we were to use was still part of the home stations; there had been no prearrangements. The only thing we had arranged was the use of the New Jersey State Police Headquarters at Wilburtha, N. J. We were again given the privilege to use their grounds, and this year we were granted shelter and some good coffee. At approximately 1:00 p.m., Saturday, eight members began to gather the necessary equipment together. Receivers had to be taken from their desks and transmitters from their racks or tables. The generator had to be carried from its resting place in the cellar to the trunk of an automobile and packed for carrying. At 2:00 p.m. we were on location putting up antennae and setting up equipment. It took the eight men a little less than an hour and a half to set up two complete stations and have them on the air. Everything went well until around 9:00 p.m., when we were visited by a bad electrical storm which put us off the air for about an hour. During the storm we learned one very important lesson; that was to inspect the location of our generator a little more closely and not set it in a hole, even though it is flat ground. The rain almost flooded our generator. Fortunately it was set on blocks, and the water did no damage even though it reached a depth of about 7 inches. The fly-wheel was in water about 3 inches, and throwing it 6 feet or more. All this water didn't stop the engine. We consider this the most successful Field Day the Trenton Radio Society has ever had. The cooperation of the members plus the success of the apparatus gave us an enjoyable outing and excellent experience in operating under adverse conditions, as the weather somewhat duplicated that of an emergency. — *W9AIR/3.*

The club set up at Rancocas, N. J., approximately 12 miles NE of Camden, with three transmitters and receivers on 3.5-, 7- and 14-Mc. c.w. Power was obtained from a 350-watt, 110-volt a.c. gas-electric generator and B batteries



#### At Red Cross Headquarters

The Greater Cleveland Emergency Planning Committee, under the leadership of John A. Kiener, W8AVH, Emergency Coördinator, operated W8DS/8 from local Red Cross Headquarters, demonstrating to the R.C. the effectiveness of amateur radio for emergency communication work.

on one receiver; 74 contacts were made on 3.5 Mc., 45 on 7 Mc. and 36 were made on 14 Mc.; 58% of our contacts were with other portable stations. We got quite a kick out of working two VK's and three KG's on 14 Mc. with 10 watts input. The F.D. started with a temperature of about 92 degrees and, in six hours, dropped into the 60's! We had our regular share of rain, too — *Beacon Radio Amateurs, W3ATR/8*.

We are looking forward to a better score next year and lots of fun again. There are now 12 emergency-portable transmitters in Norfolk, Va. — *W3BEK/8*.

Our results: 138 stations worked; 82 portable, 56 fixed (60% portables). DX: All W but 7th, VE2, 3. A good time, and a lot learned by all. The vow: Just wait until next year! — *K. B. T., Radio Club, W3NWH/8*.

We had five extension-ladder masts for four separate antennas; 14, 7, 3.5 and 1.75 Mc. — *Steuvenville Amateur Transmitter's Association, W3CHE/8*.

Learned from experience that antennas for portable and emergency work should be tried and proven just as much as the equipment, since the power output is usually low. Had difficulty trying to get the 1.75-Mc. Zepp to put out for us this year, so next time we will have separate antennas for each band! — *Philadelphia Wireless Association, W3GAG/8*.

Twenty-eight states were worked and three Canadian provinces, which we considered not at all bad for this location over a period of 26 hours, with inputs averaging only around 15 watts. — *Merrimack Valley Amateur Radio Association, W1DMD/1*.

W4NC operated Field Day this year from Farmers Fishing Camp, about 80 miles from Winston-Salem. The location is up in the mountains and on New River. The location is one of the best radio locations we have been able to find and, of course, we had already made plenty of tests to find this out before Field Day. We were equipped to operate as many as five transmitters at once, but finally wound up by using only two of them because of QRM, lack of operators, etc. Both transmitters used had 807's in the final and were run at about 50 watts input. We had two small 300-watt generators driven by gas engines, and one 500-watt generator operated from a 6-volt battery. The main generator was a 5-kw. rig that furnished power for the transmitters, lights, radio, shaving, etc. Hi! The other generators were just carried along for emergency emergency generators! For receivers we had an NC-101X, a Hammarlund Pro, two SW-3's and a small two-tube battery operated affair. Bands used were 14, 7 and 3.5 Mc. All in all, we had a very successful Field Day. We learn more and more each time, and believe we are fully prepared to handle any kind of emergency situation. Our 5-kw. portable generator is built on a two-wheel trailer and can be pulled behind a car at 50 or 60 miles per hour without any trouble at all. — *Winston-Salem Amateur Radio Club, W4NC/4*.

We ran 4.62 watts on 3.9-Mc. 'phone. Among DX worked were ZL2BN, ZL2BE and ZLACU! VK2BN reports hearing us. Antenna was a  $\frac{1}{2}$ -wave doublet with EO1 fed line. — *VE5OT*.

For the first time in three years of Field Days, the rain stayed away and the bugs, mosquitoes, etc., had their vicious innings. However, the climax of the period was at 11:47 P.M. C.S.T., June 17th, when W1AW called us in answer to our CQ and asked for our message. That, gentlemen, demoralized us completely, because in taking care of everything else the composing of the message had completely slipped our attention! So thanks for the chance to have a nice outing and especially the valuable experience at emergency operation. Preparedness Plus is our motto from now on. — *W9SFZ/9*.

We believe we had the highest vertical antenna in the contest, as we were located in the top of a 100-foot fire tower, and ran our antenna almost straight down. The fire tower was located about four miles northwest of Allegan, Mich. Believe you me, next year we will operate from the ground and take our antennas aloft, or haven't you ever carried two storage batteries, genemotors, B batteries, receivers, keys, water, etc., 100 ft. in the air? — *W3CTC/8*.

We used a complete transmitter and receiver housed in a cabinet 22 inches high, 9 inches wide and 10 inches deep, with a leather carrying handle on top. In this case is a 10-watt c.w. or 'phone band-switch transmitter, a 3-tube receiver, 6-volt vibrator power supply and 110-volt A.C. power supply, and a loudspeaker. The rig was designed for emergency communication work and is completely self-contained, needing only to be clipped onto any car battery or plugged into a 110-volt A.C. socket and the antenna reeled out. We operated entirely on 1.75-Mc. 'phone. We flew a kite in the afternoons for the antenna. A 10¢ tailless kite with No. 22 wire — no string. Excellent results. — *W6OMC/6*.

The Society of Amateur Radio Operators is a group of about forty licensed amateurs. The majority reside in the San Francisco bay district. The organization is very well equipped for emergency or field operation of any kind. This year, for the first time, we participated in the A.R.R.L. annual Field Day. Our organization was divided into two groups, one in San Carlos and the other in Oakland. Each group was entirely powered with gasoline-driven a.c. generators, each unit had one 1-h.p. and three  $\frac{1}{2}$ -h.p. engines. Unit No. 1 of Oakland used the call W6BGY and had a personnel of seventeen operators. Unit No. 2 of San Carlos signed W6VX and used fourteen operators. Each unit operated five bands simultaneously. A card index, arranged alphabetically for calls worked, was found to have been very helpful. One man periodically copied from the logs, stations worked and entered them in the index file. To prevent duplicating QSO's, the operator announced the call of the station and immediately was informed by the index man whether or not it had been worked. All channels used the one index. Each man had a specific task assigned to him. A few are as follows: Refueling the gas engines. Entering "stations worked" in the index file. Operating the file. Checking each operator's performance. Answering questions from spectators. Photography. Antenna and equipment location. Cooking. Working four and five bands at the same time, many things were learned. The following are a few: Clean modulation and clickless keying: Very essential. Receivers using good preselection and noise limiters preferable. Antennas fed by low impedance lines are preferable. The antennas were all very closely spaced to one another, four being supported on the same poles at W6BGY. No serious interference was experienced, except for the harmonics from the lower frequency transmitters. Some of the trouble, no doubt, could have been eliminated by a different selection of crystals. Unit No. 1 used 15 watts input on c.w. and received S7 from VK2YQ (14 Mc.). Unit No. 2 used 20 watts input on 14-Mc. 'phone into 2-section 8JK beam, and received S9 reports from Hawaii. — *W6BGY/8*.

A house trailer was used to house all of the equipment except the source of power. All of the comforts of home were enjoyed including ample light, electric fan, electric clock, in addition to transmitter, receiver and control relays. Power was derived from an old car generator re-wound into a self-excited alternator and driven by a Briggs-Stratton gas en-

gine. Antenna system used was a "V" beam 137 feet on each leg, with 67-foot feeders. — *W9FPO/8*.

Friday night, June 16th, I borrowed some coil forms from a fellow ham, and about 10:30 p.m. began putting together a real emergency rig to use in the F.D. I had forgotten all about the F.D. until 6 p.m., Friday, and all I had around the house was an old SW-3, and a few handfulls of junk. Hi. Threw together a single '42 crystal oscillator, mounting it on the old chassis of a 4-tube BC set. Then I proceeded to string up a 66-foot piece of wire in the house and made sure the antenna tuned OK, etc. Yep . . . it had all the earmarks of a great portable. Instead of building a portable case, I used an old egg crate, stood it on end, and put the rig on the top shelf, as well as two small 6-volt dynamotors, and the SW-3 receiver (6-volt model) on the bottom shelf. Then I wrapped the egg-crate in canvas, etc., and it made an ideal portable case (although a little bulky). Beginning from scratch, a portable transmitter was built and working in four hours, and together with a receiver (ready-made) the entire portable station was ready for operation anywhere. — *W7RT/7*.

Held outing for the members and families on Sunday, but never again. The children hinder operators and lowered our score. No outing, just work, next year. We're out to win yet!!! Almost tripled our last year's score. Used two V beams which helped considerably; 137 feet each leg on North-South beam and 274 feet each leg East-West beam. — *Manchester Radio Club, W1DJC/1*.

Here is a tip on putting up antennas for Field Day. Use ordinary binder twine for guys. Two strands of binder twine substituted for each guy will eliminate the need for insulators to break up the guys. It is surprisingly strong. It held up our poles through wind and rain here in west Texas, and the wind does blow. Another nice feature: When you are through with the antenna, cut the guys off and burn them with the rest of the camp refuse. One roll of binder twine costing about 65 cents will guy about six 40-foot antenna masts. — *W6GPJ/5*.

Our operating position was again in the back seat of the car, and we believe that few fellows have a more comfortable operating position even at home. A table was built to hook on the back of the front seat and the arm rest of the back seat. Our antenna was more or less of an experiment in long wires. We have never had the space to try one before, and it performed well. We had a swell time, and plan to be out again next year. We will still only use one transmitter and one receiver. We don't believe in rigs that you need a truck to transport! — *VE5GZ*.

Operated station alone in open field from car, on 3.5- and 7-Mc. c.w. and 3.9-Mc. 'phone. Had an enjoyable time working 'em with 5 watts. — *W8KO/8*.

This was the first time our club ever held a Field Day Meet, and we must say it was a huge success. A tent was rented, and we were fortunate enough to secure a private location on a high point overlooking Eagle Mountain Lake about 16 miles northwest of the city of Ft. Worth. The weather both Saturday and Sunday was wonderful, and enough breeze was blowing to keep us cool and comfortable. Two 56-Mc. transceivers, a motor boat and a surf board entertained the balance of the crew when not around the operating tent. All districts were worked, and all continents heard during the night. — *Kilocycle Club, W8HCA/5*.

Boy, oh, boy, the F.D. has EVERYTHING! It calls for plenty of previous planning, building and especially testing, choice in location, equipment, antennas, and personnel — with a few chunks of team-work, elbow grease, stick-to-itiveness, and cooperation thrown in for good measure. We were in a big barn five miles west of Montreal. Went out Thursday night, took bearings for proper direction of antennas. Friday night we put up three of 'em. Saturday morning the fun began in earnest. One gang got the three complete stations set up by 11:30 a.m. when our 4-cyl., 1.5-kw., 110-volt gas engine-driven alternator arrived with the other boys. This baby weighed 725 lbs., and we had to get it off the truck, as the latter was being used later. The generator started first shot, but imagine our dismay when, despite suppressors, the hash in the receivers washed out the loudest sigs on the band! Three and a half hours of frenzied cut and try with tuned filters reduced this noise by 75%, but even

so, one got pretty well deafened after operating for half an hour. We got on for 4 p.m., and you can imagine the shouts of joy when we clicked with W1DJC at 4:06. 'Nuf sed. The temperature dropped to 38 degrees at night, and we nearly froze. Then the Northern Lights got busy and washed out all sigs — but that's a field day! There seemed to be far more F.D. stations on than ever before. — *Montreal Amateur Radio Club, VE8CO*.

The club now owns a complete emergency power plant built by club members themselves. A re-wound "Dodge" generator coupled to a  $\frac{3}{4}$  h.p. "Briggs & Stratton" gas engine provided plenty of 110-volt a.c. for operation of all transmitters, receivers, lights, etc. Three 20-watt transmitters were in constant operation, covering five bands. All equipment was powered from 110-volt a.c. source, with two 110-volt generators in reserve. Conditions were far from ideal, due to bad "fade-out" periods when no signals were heard, or weak, on all bands. Local thunder showers prevailed, with high static level, but rain did not keep us off the air. — *Delaware Valley Radio Association, W3AQ/8*.

The *Helix Amateur Radio Club* operated during Field Day on the Coronado Strand, across the bay from San Diego, Calif. We used our emergency trailer unit as well as two other small rigs. DX-conditions were very good. All rigs were kept under the 20-watt limit, and power was supplied by a gas engine-driven alternator. Weather was FB and a fine time was had by all. — *W6MGJ/6*.

There were six of us and one XXL to cook — hi. We toured down to Skyline Drive in the Shenandoah National Park in Virginia. It is at an elevation of over 3000 ft. The whole thing worked fine, and we had five times the score we had last year. We tried using a kite antenna, but the wire broke after it went up over 1000 ft., and so goodbye to three nights' work and \$1.00 worth of material. — *W3EYX/5*.

Best hint we can offer to other Field Day outfits in the future is to make a written list of everything that will be necessary on the Field Day. Make this up weeks before — and whenever anything occurs to you, write it down. Then take everything along — using the list to make sure nothing is left behind. This will save a lot of grief — as I'm sure it did for us. — *Key Kite Klub of Detroit, W8MGQ/8*.

Transmitter — 6V6 crystal osc., 6L6 final. All single wire feed antennas used. Motor generator from 12 volts storage. Receiver was QST three-tube super, 90 volts "B." On 1.75-Mc. 'phone — 42 crystal, 42 final, 42 mod., 3.8 watts. All built in auto receiver case. Vibrator power supply. Receiver t.r.f. Truly portable-emergency equipment! — *The Aerial Club, W8MLV/8*.

All the gear was set up in an abandoned school bus body on the farm of William Brown, 6 miles east of Raleigh. A shelter was hastily constructed to protect the power supplies when clouds began to gather. About 40 people, hams, their YLs and XYLs and children gathered for a weiner roast at 6:30 p.m. — just after we closed down. — *Raleigh Amateur Radio Club, W4DW/4*.

We operated from a camp at Upper Sackville, N. S., about 20 miles from Halifax. Three complete units were operated simultaneously, one each on 3.5, 7 and 14 Mc. The equipment was all within 100 feet of one point, the 3.5- and 14-Mc. rigs being approximately 20 feet apart and the 7-Mc. rig about 70 feet away from the other two. All operation was from battery power. — *Halifax Amateur Radio Club, VE1MK*.

The *Bluefield Amateur Radio Club* 1939 Field Day camp was located near Hicksville, Bland County, Va., about 16 miles southeast of Bluefield. The station was located in a one-room log cabin beside Wolf Creek, and two tents were used for sleeping quarters. For the first time on our Field Day outings, a good swimming hole was available. It was in constant use. As some of the crew reached the camp as early as Wednesday, everything was set up and tested before Saturday, and no equipment failures of any kind were experienced. The power supply didn't even run out of gas during the contest. With our station housed under a wooden roof for the first time, of course it never rained a drop! We felt almost cheated. — *Bluefield Amateur Radio Club, W8MCL/8*.

*Southwest Michigan Radio Club* reporting! And boy! Did we have fun! It is our second F.D., but we are improving

and learning. Site of operations was in the sand dunes high above Lake Michigan, about 6 miles south of St. Joseph. We are already planning on next year! — *W8HKT/8*.

This is the first time that the B.R.A.R.C. has participated in Field Day activities. We had a grand time. Fifteen members of the club combined a week-end of camping with Field Day on the Amite River, about 15 miles east of Baton Rouge. Two hour operating shifts were arranged, and two men were on duty at a time; one to operate and the other to use the Flit gun. In this way all men took turns at the key. Activities outside of operating were many and included swimming, target shooting, poker games, soft ball, etc. In fact, a bit of almost everything except sleeping. — *Baton Rouge Amateur Radio Club, W5AFW/5*.

The *Tri-Town Radio Amateur Club* operated three portable rigs out in an open field, a mile and a half north of St. Johns, Ind. The most interesting antenna was a flat top, 840 feet long, which was stretched across the lake! This antenna increased reception about ten times, and seemed to increase the efficiency of transmission radiation many times. This was the club's first Field Day outing, and it was enjoyed by all who took part. The gang slept in tents and ate and camped right at the scene of operations. Fair DX was had on 1.75-Mc. 'phone, but the prize contact was with the 6L6 oscillator with about 6 watts input to the long wire antenna, which raised VK2AX in Australia and received a 459 report. — *W9MWJ/9*.

*W6GGS/5* operated at the water tower in the Bastrop State Park. A kerosene motor generator with 32 volts d.c. output was used to keep a bank of auto batteries charged. During transmissions, these batteries were used to run a 110-volt a.c. converter, furnishing power to regulate a.c. power supplies for the 6V6-6L6GX rig, with about 15 watts input. For receiving, the batteries were switched to a 32-volt/180-volt 40-ma. converter. The receiver used was an AGSX. — *W6GGS/5*.

A marvelous F.D. — my fifth and best! Had the finest location imaginable — on a plateau of the White Mountains, Arizona, 7000 ft. above sea level, on the shores of a lake. Signals were actually so loud on my two-tube blooper that I had to keep the cans around my neck most of the time! Got a great kick out of raising VK2AX on 7 Mc. with my 12 watts. Almost froze to death (34°) — also a high wind. — *W6QAP/6*.

We set up in a new unoccupied house of one of the members. We operated on 7- and 3.5-Mc. c.w. and on 3.9- and 1.75-Mc. 'phone, using four different rigs. All rigs were 20 watts or under and all on emergency power furnished from a 3-kw. gas-driven generator. Our engine was a 1924 Chevvy. We are planning on installing this emergency power in the Central Vermont Public Service Building (Rutland), where we will maintain an emergency station for use at any time. — *Green Mountain Radio Club, W1GAN/1*.

The *Tulsa Amateur Radio Club* was out again in force for the annual Field Day, operating portable on top of Turkey Mountain, seven miles south of Tulsa. The new club call, *W5IAS/5*, was used. Rigs were available on 3.5-, 7- and 14-Mc. c.w. and on 1.75-, 3.9-, 14- and 28-Mc. 'phone. As many as six antennas were in the air at one time, mostly doublets. Power was supplied for all rigs but one by a portable 1 kw. gas-electric plant, supplied the club by FWZ. — *W5IAS/5*.

We were located on the Gulf Coast near High Island, Texas. It is a wild, desolate location. High winds, bringing in heavy waves, along with an unusually high tide added to our difficulties, and all of us felt as though we had been through an actual emergency before the Field Day contest was finished. Salt spray and blowing sand were equally as hard on the equipment as on the operators. One of the transmitters had to be taken out of service and fully cleaned, as the salt spray had coated everything until it looked like a frosted window in the winter time. We demonstrated, to our own satisfaction, that the equipment and power supply we had assumed to be adequate for an actual emergency was not good enough. Steps are now being taken to provide much better and more reliable gear. — *Sabine District Amateur Radio Club, W5FKU/5*.

The *Chair City Radio Association*, from Gardner, Mass., set up two transmitters and two receivers at Wilnot, N. H.,

under conditions about the same as would be encountered in an actual emergency. The club was planning to operate a gasoline engine to drive a rewind Dodge generator to furnish 110 a.c. The gasoline motor was started up and everything was fine for about five minutes, when the motor coughed and died and, in spite of everything we tried, it refused to start again. The location was several miles from any garage or repair shop, and the starting time of the contest was only a few minutes away. Something had to be done! Why not use one of the automobiles to drive the generator? We selected one of the cars that had drop center rims, and jacked up a rear wheel and took the tire off. But now what would we use for a belt? At last we found some cotton rope that one of the fellows had brought along to hold up a tent. Three loops were made of the right size, and after the two ends were spliced together the whole thing was wrapped with friction tape. By staking down the generator frame with tent stakes, and putting some tension on the belt by running a tow rope to another car, the club finally managed to get some power. The belt lasted about three hours, when it was replaced with another one made up the same way. When this one went "west" a 30-mile trip was made in a vain attempt to secure more tape and rope, or a regular belt. Nobody in the state of New Hampshire seemed to have any belts, or any rope or tape that we could get at that time of night. Consequently the station was off the air until Sunday morning when more rope and tape was obtained, and belts were made up. — *W1KIK/1*.

The Field Day was enjoyed very much by those who got out. We operated in a temporarily close brickyard. The transmitters and power supply were located under the shed and in the boiler room. The chimney (75 feet high) and the shed (60 feet high) were utilized for the antennas. The a.c. was supplied by a gas-driven generator (1 kilowatt) which gave a very fine performance. — *Chicago Suburban Radio Association, W9PNV/9*.

Not much of a score to crow about, but we sure rolled out the barrel and had the fun. This was the first whack at Field Day for each of us in this party and there's no doubt but what we all learned plenty. — *W9TQD/9*.

Our station was placed in *W7BDP's* cabin's garage 10 miles SE of Butte, right in the Continental Divide at an altitude of about 7000 feet. Most of the time the temperature was below freezing and no heat was available. To keep warm the operators had to place hot-water bottles inside of their jackets. Even then we got our feet very cold. The unlicensed members of the club acted as log operators and all-around handy men. This Field Day was much more successful than last year's in many ways. We had more contacts with less power and time. Two things which helped our score this year: (1) We filtered all of the noise out of the generator, and (2) we used seven 7-Mc. crystals. The transmitter didn't have to be retuned when a new crystal was put in. — *Butte Amateur Radio Club, W7FRS/7*.

The *Starved Rock Radio Club* held its Field Day activities near Henry, Ill., again this year. The location was a hunting lodge on the east side of the Illinois River, 1.7 miles east of Henry. Three transmitters were used, two in the lodge and one was located in a tent part way up the hill. A 1-kw. gas-driven generator was used to supply the power to the various units. The receiving equipment consisted of one RME69, one HRO Jr., two SW3's and one home-made battery receiver. A schedule was made up previously and the operating time was divided among the operators present, so that each man had a chance to operate each one of the three rigs used. There were plenty of tall trees near the cabin and, with the help of two 4 x 4 poles donated by *W9QLZ*, the antenna situation was quickly taken care of. Operation was confined to the 14-, 7- and 3.5-Mc. c.w. bands. — *W9MKS/8*.

It was great stuff! We learned how to copy code and sleep at the same time! Nearly all of the club members were present and most of the operating crew stayed up all night so we could have a decent score. The antenna crew should be mentioned, as they did a very fine job of cutting antennas to frequency. Food was taken care of by our hosts, Thomas Brown and his wife, who did a lion's share of work keeping the operating crew well fed! The food was excellent, weather

(Continued on page 108)

# Five Bands Without Changing Coils

**Ganged L-C Sections in Combination 5-Band Tank for Transmitters**

BY T. M. FERRILL, JR.,\* WILJI

No plug-in coils, no switches — but any frequency in any amateur band from 1.75 to 30 Mc. simply by setting the tuning dial. That's what the ganged condensers and coils shown here will do. An extension of the three-band system described in November *QST*.

WHERE amateur transmitter operation is confined to three consecutive low-frequency bands — 1.75 through 7 Mc., or 3.5 through 14 Mc., — the ganged tank units described in November *QST*<sup>1</sup> provide great operating convenience. Band change is effected by readjustment of the amplifier tuning dials, without any switching operation or hunting for the correct coil for the band desired.

Two complete tanks may be interconnected in such a way as to retain the features of the 3-band arrangement, but with coverage of five consecutive amateur bands — 1.7 through 30 Mc. circuits for accomplishing this are given in Fig. 1.<sup>2</sup> The combination circuit consists of the low-frequency 3-band tank inserted between the divided halves of a coil in a 14- and 28-Mc. ganged tank. The high-frequency condenser stators and the outer ends of the high-frequency coil are then connected together, and tuning, neutralization, and coupling of the r.f. stage are adjusted just as with ordinary single-band tuning tanks.

\* National Company, Malden, Mass.

<sup>1</sup> Ferrill, "A Single-Control Wide-Range Tank Circuit," *QST*, November, 1939.

<sup>2</sup> Patent applied for.

In this model of the 5-band tank circuit, the condenser and coils are mechanically linked so that the tuning is single-control. The two rotor coils are turned by the same insulating shaft. Coil specifications are as follows: Low-frequency section, rotor 8.5 turns of No. 10, length 1½ inches, diameter 3½ inches; stator 8 turns of No. 14 each side, length 1 inch, diameter 4 inches, 1-inch space between sections. High-frequency section, rotor 4 turns No. 8, length 1 inch, diameter 3 inches; stator 5 turns each side, length 2 inches, diameter 3½ inches, ½-inch between sections. The larger condenser section has a maximum capacity of 220  $\mu\text{fd.}$  per section; the smaller, 80  $\mu\text{fd.}$  per section. The circuit is that of Fig. 1-A.

The combination tanks may be used throughout a low- or high-power transmitter, or they may be used in r.f. amplifiers following a band-switched exciter — in either case, operation on five amateur bands, with frequent jumps from one to another, may be accomplished with as much ease as has heretofore applied to frequency shifts within one band.

Although no strenuous attempt has been made to hold the effective  $L/C$  ratio (i.e., the tank circuit  $Q$  under operating conditions) rigidly constant throughout the 5-band tuning range of the system, the variation in this ratio does not exceed 2 to 1 in the unit shown in the photograph. This is accomplished partly by the use of sufficient  $C$  for the lowest frequency and partly by the use of a specially-designed high-frequency tank condenser section having low minimum capacity. This variation compares strikingly with the 16-to-1 range in  $L/C$  ratio usually found in plug-in coil tanks over the same frequency range.

The efficiency of the combination automatic 5-band tank compares favorably with that of plug-in coil tanks, and is superior to that of switched-turn systems where the 5-band tuning range is covered in two separate tapped coils for each tank circuit.

## Circuit Arrangement

A first glance at the circuit diagram of Fig. 1-A probably would suggest that such an unusual-looking arrangement would not be electrically balanced — at least, not in an actual assembly with all required connections. But closer study of the photograph and circuit will show that the

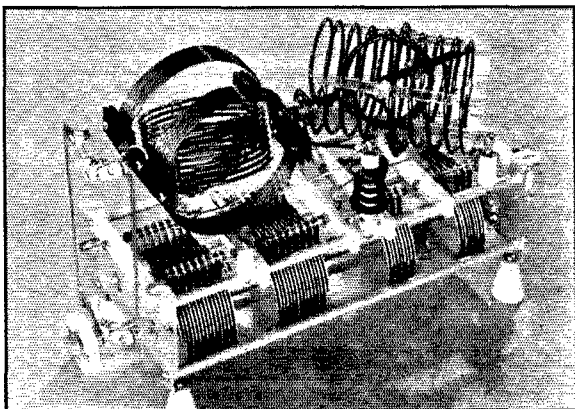



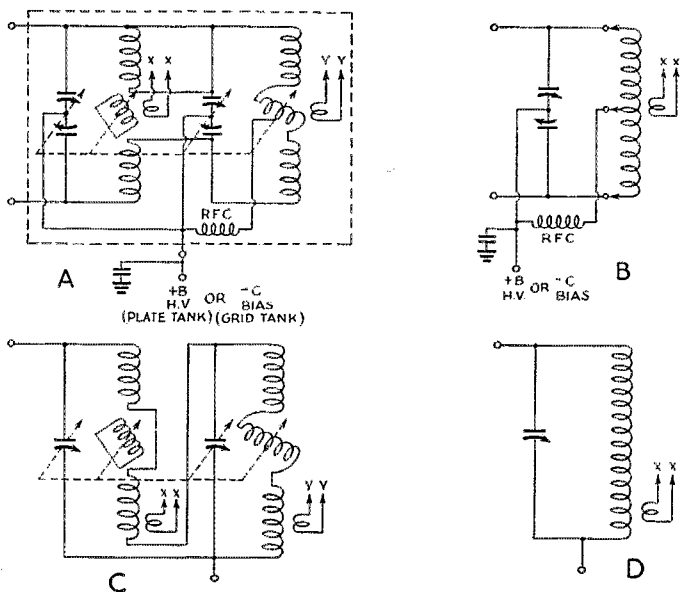

Fig. 1 — Actual connections of the 5-band tank circuits (A and C) with their corresponding simplified equivalents at the right (B and D). A and B are amplified circuits for push-pull or plate neutralized amplifiers, C and D single-ended circuits.

somewhat increased number of parts and connections need not interfere with the operation of the tank. Tests in actual use in a 5-band transmitter have shown that the circuit is balanced and neutralization remains fixed through five bands.

Probably of even more concern than the subject of circuit balance is the question of selecting the proper section of the combination tank circuit. Actually, no switching is needed since the section which is resonant at the applied frequency functions automatically with only minor effects from the other section.

Where one combination tank is used for grid tuning in a stage following a combination plate tank circuit, two separate links are used. One of these links serves only on the low frequencies, carrying power from the low-frequency section of the coupled grid tank. Another link couples the high-frequency plate tank section with the h.f. coil of the grid tank. There is little variation of loading (or coupling) through the tuning range of either section, and separate adjustment of the links by which the sections are coupled makes possible reasonably-constant coupling throughout the entire 5-band tuning range.

#### Design Details

A detailed description of the low-frequency section of the combination tank was given in November *QST*.<sup>1</sup> The high-frequency section in the combination tank is somewhat different in

general circuit and mechanical arrangement from the low-frequency section, and will bear a few separate comments.

In the low-frequency tank section a rotor coil connected in series with the stator coil is rotated through 180 degrees to give maximum variation of inductance. The high-frequency tank section, on the other hand, employs a shorted rotor coil which is moved from a position with its axis perpendicular to the stator coil axis, for maximum inductance, to a position with the rotor and stator coils coaxial, for minimum inductance. With the rotor shaft running at right angles to the axis of the outer coil in normal fashion, this would mean that only 90-degree rotation of the rotor would give complete variation

between minimum and maximum inductance. A 2-to-1 gear reduction ratio would be required for ganging with an ordinary tuning condenser. To avoid this, a system used in the old "3-circuit tuners" is employed. The high-frequency coil is mounted with its axis at 45 degrees to the rotor

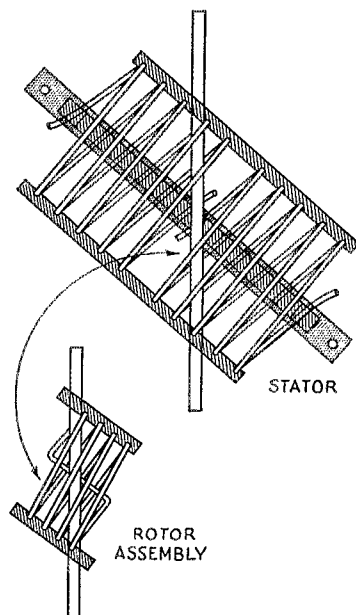

Fig. 2 — In the high-frequency coil the shaft is placed at an angle of 45 degrees to the stator, giving 180-degree shaft rotation for 90-degree movement of the rotor.

shaft rather than at 90 degrees, so that a rotor coil also at a 45-degree angle to the rotating shaft requires 180-degree shaft rotation between the perpendicular and coaxial positions.

In the complete tank illustrated, all condenser sections and coils are mechanically coupled for simultaneous rotation from maximum to minimum capacity and inductance. The mechanical arrangement of these coil and condenser sections offers several possibilities, the best of which appears to be that chosen. The two coils are mounted "fore and aft" on a special double-section condenser with ceramic supports. For chassis layouts where the plate connections of the transmitting tubes are brought out on top, several inches above the base, the "upstairs" connections of the tank are particularly convenient. This layout is also well suited for the vertical chassis type of construction.<sup>3</sup>

The tuning condenser combines a high-capacity and low-capacity split-stator condenser in one assembly. The low-capacity sections are placed together at one end of the unit, while the high-capacity sections are at the opposite end. Direct wiring of the tank sections is thus facilitated.

All of the coils are air-wound, with four strips of supporting material at 90-degree intervals around them. In the stator windings the strip at the bottom serves as a mounting support, while the front and back strips provide bearings for the rotor shafts. The front and back strips of the high-frequency rotor coil are extended in opposite directions well beyond the ends of the winding, as shown in Fig. 2, to provide for the 45-degree shaft mounting. Fig. 2 also shows the method by which the mounting effects 180-degree rotation of the inner coil for the h.f. tuning range.

While the low-frequency tank is substantially the same as that shown in November *QST*, a small reduction in the inductance was necessary to compensate for the increased maximum tuning capacity supplied by the high-frequency section. The two split-stator condensers are effectively in parallel when the low-frequency tank is operative, since the reactance of the series high-frequency coils is low at the low frequencies.

A more important alteration in the low-frequency inductance assembly is replacement of the "pig-tail" rotor connections by three wiping contacts similar to those used for variable condensers. Two collars are mounted on the rotor shaft between the inner and outer coils, and are connected to the ends of the rotor winding. Standard condenser wiping blades are fixed on the front and back supporting strips to make connection between the rotor collars and the divided halves of the outer coil. A third collar is mounted on the rotor shaft outside the assembly, with a connection brought through the drilled center of the shaft from the center tap on the rotor coil.

<sup>3</sup> Ferrill, "New Ideas for Transmitters," *QST*, September, 1939.

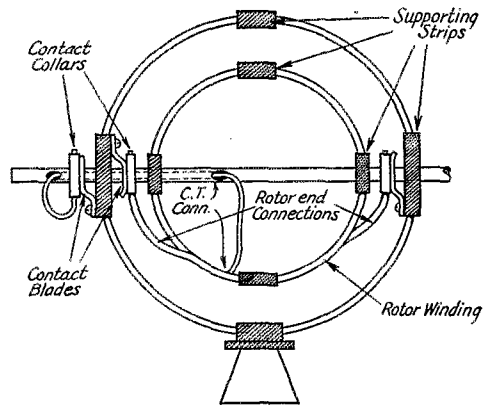

Fig. 3—Contact details for the low-frequency coil assembly. The collars and contact blades are the type used in transmitting condensers.

This collar, with a third wiping blade, provides the d.c. connection to the center of the inductance. Details of the low-frequency coil connections are shown in Fig. 3.

### Applications

The combination 5-band tank may be a balanced or unbalanced arrangement, depending on the circuit in which it is used. For the plate circuits of transmitting triodes, single or push-pull, and for all push-pull plate circuits with screen-grid, beam-power, and pentode tubes, the balanced arrangement of Fig. 1-A is preferable. The unbalanced tank is suitable for the grid circuits of single-tube r.f. stages, but the balanced arrangement is much more suitable for push-pull grid circuits. The double links mentioned above are suitable for coupling a single-ended plate tank to a balanced grid or antenna tank, or for coupling a balanced plate tank to an unbalanced grid tank.

A special tank condenser similar to that of the photograph, but employing only one large-capacity and one small-capacity section, is used in the single-ended tank. Coils for the single-ended tank are similar to those for the balanced unit, except that no center-tap connection is used on the low-frequency section and the link coils are wound around the cold end of the coil.

Some misgivings were felt about the sharpness of tuning of a tank which covers such a wide continuous frequency range in 180-degree dial rotation. Experience has shown, however, that while the tuning is sharp it still can be accomplished quite satisfactorily without a vernier dial. This is especially true with the tank circuit loaded in actual operation. As an illustration, the tuning ranges with the unit described on a 100-division dial are as follows: 1.75 Mc., 3 to 18 on the dial; 3.5 Mc., 40 to 49; 7 Mc., 75 to 80; 14 Mc., 29 to 34; 28 Mc., 90 to 97. On the other hand, vernier

(Continued on page 86)

# Revamping the 30FXB for 28 and 56 Mc.

**An R.F. Unit to Work with Existing Power Supply and Modulation Equipment**

BY LLEWELLYN BATES KEIM,\* W2IKV

**M**ANY an amateur who owns a Collins 30FXB has had the desire to take a fling at ten meters, but the r.f. unit in this transmitter is not especially intended for the higher frequencies and will not percolate there without circuit losses that consume more of the input than ever reaches the antenna. Owning a 30FXB is my good fortune, along with many other American and foreign amateurs, and I shall try to describe how I have fared in putting this outfit on the higher frequencies.

All efforts to revamp the present r.f. line-up were abandoned at the outset, partly because it worked so very well on the frequencies for which it was originally designed, and partly because as the idea of expanding the frequency range of the outfit grew, along with it came the desire for bandswitching. In consequence, the new unit was designed to use the audio, modulator, and power sections of the 30FXB, so that only a radio-frequency chassis need be constructed for 28 and 56 Mc. Needless to say, this is a most economical approach to the problem, since the auxiliary equipment is the most costly part of any 'phone rig.

\* 33 Sunset Drive, White Plains, N. Y

Serious consideration was given to the question of how best to obtain 200 watts input, making use of the available voltages from the Collins power supply. Early in the process it became evident that much better results could be obtained through the incorporation of two filament transformers in the new unit, forgetting about the voltages already at hand. However the plate and bias voltages were more than adequate, and with the system of plugs and two switches to be described you can shift from one r.f. unit to the other in less time than it takes in telling. And the new unit is fully metered in all stages, through the use of the meters already installed in the FXB.

The matter of cost is important to every ham, and in consequence a budget of fifty dollars was set for this job, this to include everything necessary except crystals for 28 Mc. With about 300 ma. at 1000 volts available, without overloading the power supply, the problem of obtaining the most output for this available source of plate supply resolved itself into the use of suitable tubes. Others than those chosen might be used, but from the performance in the past month of the new unit, my recommendation is to follow the present layout.

The diagram shows the wiring of the unit. The T21 harmonic oscillator uses a 40-meter crystal, and delivers 20-meter output. The second T21 doubles to ten meters, driving the TZ20 to about 28 ma. rectified grid current without plate voltage on this stage. In working on 56 Mc. this stage serves as a power doubler, and will deliver ample excitation for plate modulation of the two T40's in pushpull in the final amplifier. If 5-meter operation is not contemplated a T20 can be used in the driver, but the ease of excitation of the higher mu tube is certainly in its favor.

All parts used are standard; those mentioned in the list at the end of the article were used in the author's outfit, but others of similar characteristics can be substituted. The small standoff insulators packed with the sockets specified were all needed for

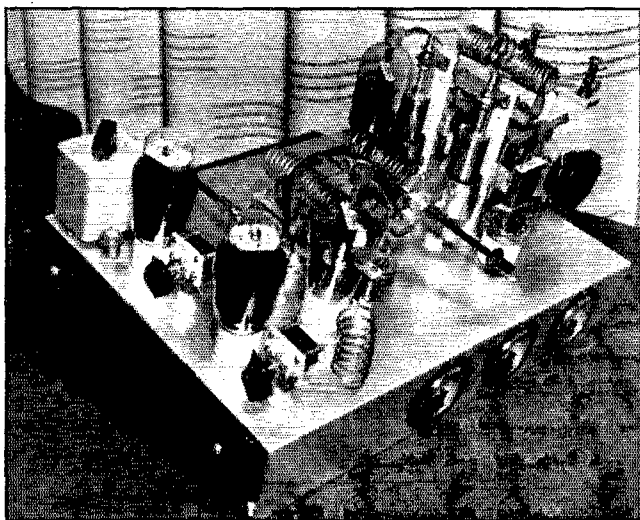

The new unit is a complete 28-56-Mc. r.f. section, independent of the r.f. end in the 30FXB. This view shows it fitted with brackets to mount behind the regular r.f. section inside the cabinet.

the outfit, and a change in this item might mean the purchase of a few additional units. Otherwise you can select your own preference, but please observe one point: The values as specified are rather critical, and use of something from the junk box may mean untold grief, especially in the harmonic generator stage, if the values are far off the specifications.

There are two ways of mounting the new transmitter on the 30FXB. It can either be mounted on the rear with a pair of chassis brackets turned out, as shown in one of the photographs, or it can be mounted on top of the transmitter, in which case a somewhat different parts arrangement will be necessary to present a uniform panel appearance and give full control of all circuit tuning adjustments from the front panel.

However it was not practical in my case to follow the latter layout, and so the unit was mounted as first described. Because of the position of the transmitter in the room, there is a slight cutting of corners in the photo, but it more than illustrates the general idea. And it shows the parts layout clearly, especially the final amplifier. The other photograph shows the oscillator section and doubler stages more in detail.

Everyone has his own particular scheme for parts layout, but that shown evolved from a careful study of the problem of making all leads as short as possible (under the chassis as well as above) and still allowing adequate room for the proper placement of the components in each stage. Adequate by-passing is an essential at high frequencies, and though it may appear as if more than the ordinary amount of by-pass condensers are indicated, they are all essential for the proper

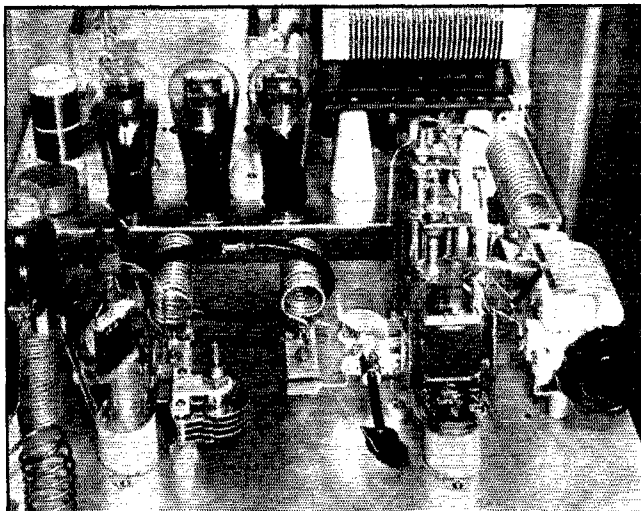

Mounted in place in the transmitter cabinet, the 28-56-Mc. transmitter requires only a few simple connections to the existing power supplies and modulation equipment.

performance of the unit. Since the oscillator and doubler stages do not involve a shift of frequency, their plate coils were soldered to the tuning condensers, and the whole assembly supported by a  $\frac{1}{8}$ -inch standoff. This makes for short leads, and the coil turns can be spaced to allow the least possible mesh of the condenser plates to hit resonance. The buffer tank and final grid and plate tank coils are mounted on jack bars made of isolantite,  $3\frac{3}{4}$  by  $\frac{3}{4}$  by  $\frac{1}{4}$  inches in size. These plug into jack standoff insulators, as shown, since these three coils must be changed in going from 28 to 56 Mc. All coil dimensions are given in Table I. The only parts that are not standard are the brackets which support the final tank coil on the condenser, and which serve as the tank leads between the coil and condenser. They were fashioned from a piece of  $\frac{1}{2}$ - by  $\frac{1}{2}$ -inch right-angle aluminum, with all ends and edges rounded. Holes were drilled to pass the banana jacks and the screws available on the condenser frame. The isolantite pillar at the extreme end supports the antenna coupling coil and terminals, on an isolantite bar of the same dimensions as those used for mounting the coils and their jack bases. You may have a bit of trouble locating a pair of double binding posts for this purpose, but they can be had, and serve most handily.

TABLE I  
COIL DATA

$L_1$	— 16 turns No. 12, 1-inch diameter, air-wound, 2 inches long
$L_2$	— 6 turns No. 10, 1-inch diameter, air-wound, $1\frac{1}{4}$ inches long
$L_3$	— 28 Mc.: 14 turns No. 10, 1-inch diameter, air-wound, $2\frac{3}{4}$ inches long
	56 Mc.: 6 turns No. 10, 1-inch diameter, air-wound, $1\frac{1}{4}$ inches long
$L_4$	— 28 Mc.: 12 turns No. 10, 1-inch diameter, air-wound, $2\frac{1}{4}$ inches long
	56 Mc.: 4 turns No. 10, 1-inch diameter, air-wound, 1 inch long
$L_5$	— 28 Mc.: 16 turns No. 10, 1-inch diameter, air-wound, $2\frac{3}{4}$ inches long
	56 Mc.: 6 turns No. 10, 1 inch diameter, air-wound, $1\frac{1}{4}$ inches long

Some good dope, not only for the owners of 30FXB transmitters, but also for others looking for a ten-and five-meter outfit of the 200-watt input level. Not difficult or expensive to build, modern design — and satisfying performance.

Two types of final tank coil are shown in the photographs. Either is suitable, but the split one is handier to use with the sliding link, to adjust the degree of coupling. They each have the same number of turns, with one-inch spacing at the center of the split coil.

The 30FXB uses one four- and one five-prong plug to bring the power to the r.f. unit. These are removed from their respective sockets, and inserted in the sockets which are attached to the new unit. These sockets must be on sixteen-inch leads, since the Collins plugs just reach their unit, and the new plugs are inserted in the sockets vacated by the Collins plugs. The two double-pole

double-throw switches shown are mounted on the base plate of the ten-meter unit and are supplemented by a toggle switch to control the filament transformers. Thus three simple switches control the frequency on which the transmitter will run.

Whereas there were three stages originally, we now have four to be metered. The "First Amplifier" meter measures the plate and screen current of the harmonic generator when the switch beneath it is open, and the combined current of this and the doubler stage when closed. This is the same process as followed in the Collins scheme. The TZZ20 plate supply is carried through a piece

(Continued on page 90)

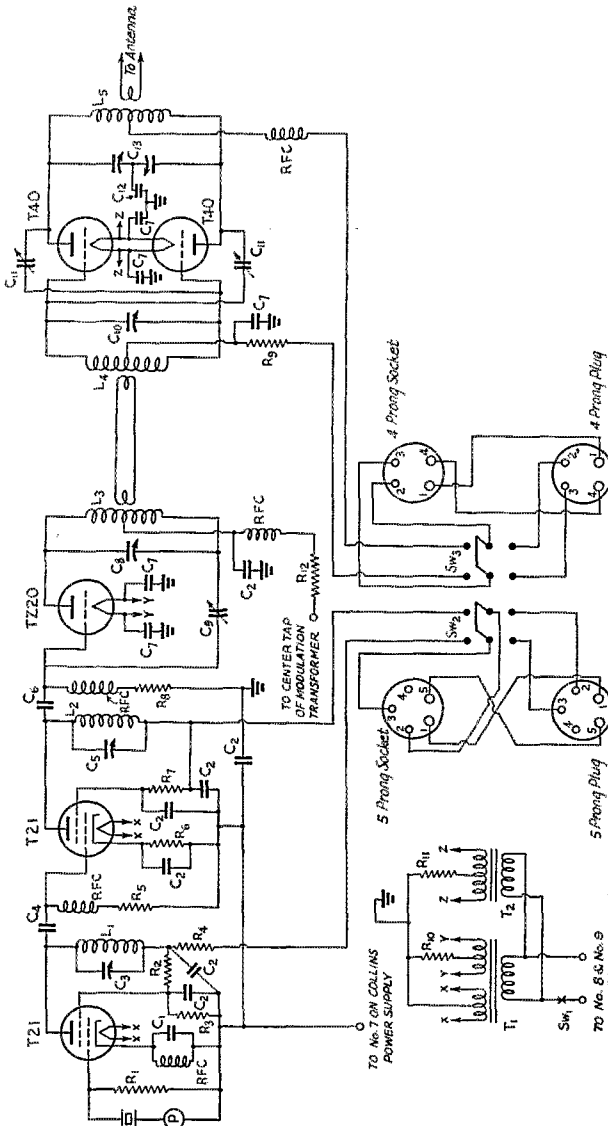
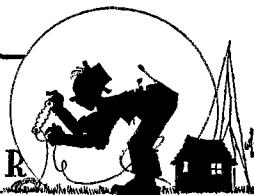

Fig. 1 — Circuit diagram of the 28-56 Mc. R.F. unit

- R1 — 100,000 ohms, 1-watt (IRC).
- R2 — 10,000 ohms, 10-watt (Ohmite).
- R3 — 35,000 ohms, 2-watt (IRC).
- R4 — 5000 ohms, 20-watt (Ohmite).
- R5 — 50,000 ohms, 10-watt (Ohmite).
- R6 — 200 ohms, 20-watt (Atlas).
- R7 — 25,000 ohms, 10-watt (Ohmite).
- R8 — 5000 ohms, 10-watt (Ohmite).
- R9 — 2500 ohms, 10-watt (Ohmite).
- R10 — 400 ohms, 10-watt (Ohmite).
- R11 — 200 ohms, 10-watt (Ohmite).
- R12 — 3500 ohms, 50-watt (Ohmite).
- R13 — 150,000 ohms, 600-volt (C.D.).
- C1 — 150- $\mu$ fd. mica, 600-volt (C.D.).
- C2 — 0.01- $\mu$ fd. paper, 600-volt (C.D.).
- C3 — 350- $\mu$ fd. variable (Cardwell ZR-35-AS).
- C4 — 100- $\mu$ fd. mica, 2500-volt (Sangamo).
- C5 — 0.002- $\mu$ fd. mica, 600-volt (C.D.).
- C6, C7, C8, C9, C10 — 35- $\mu$ fd variable (Hamamathud MC-35-MX).
- C11 — 18- $\mu$ fd. neutralizing (National NC18).
- C12 — 12- $\mu$ fd. neutralizing (Johnson N-125).
- C13 — 0.001- $\mu$ fd. mica, 2500-volt (Sangamo).
- C14 — 35- $\mu$ fd. split-stator variable (Cardwell NP-35ND).
- RFC — 2.5-mh. radio-frequency chokes.
- P — Pilot light, 6.3-volt, 150 ma.
- SW1 — Toggle switch s.p.s.t.
- SW2, SW3 — Double-pole double-throw porcelain switches, miniature, with mounting standoff insulators.
- T1 — Filament transformer, 6.3-volt, 4-amp. and 7.5-volt, 3-amp.
- T2 — Filament transformer, 7.5-volt, 8-amp.
- T3 — Filament transformer, 7.5-volt, 4-prong plug and socket.
- T4 — 4-prong National sockets CIR.
- T5 — 5-prong National sockets CIR.
- T6 — 6-prong National sockets CIR.
- T7 — Pairs of "Burt-Ins,"  $\frac{5}{8}$ -inch feed-through insulators,  $2\frac{3}{4}$ " jack standoffs/insulators.



# HINTS AND KINKS FOR THE EXPERIMENTER



## AN EFFICIENT AND EASILY-MADE FEEDER SPREADER

IN THIS day of more and longer transmission lines, the average ham finds that the cost of feeder spreaders is an important item if the commercial variety is used. Wooden spreaders, although cheap, introduce serious losses in wet weather, particularly if used on tuned lines.

After giving the matter considerable thought, the spreader shown in the sketch of Fig. 1 was conceived and a number of them made up and put to use. They have proved to be perfectly satisfactory.

The body of the spreader is made of ordinary glass tubing cut to the length desired. The tubing used here was 8 millimeters outside diameter which is the easiest to work, although tubing as small as 6 millimeters o.d. can be used. After cutting to length the ends of the tubing should be smoothed with emery paper or fire polished in a gas flame. Next, a stick of ordinary sealing wax is softened cautiously over a flame or hot plate until it can just be molded with the fingers and is formed into a rod approximately the size of the inside of the tubing. The end of the tubing is warmed above the melting point of the wax and the rod of wax inserted about  $\frac{3}{4}$  inch into the end of the tube. If necessary, the tube may be warmed again to insure adhesion of the wax to the inside of the tube, sealing out moisture.

Next, a number of pieces of No. 18 bare copper wire, 4 inches long, are cut and bent to a hairpin shape and each leg is bent again,  $\frac{3}{4}$  inch from the loop, to form a T, as shown in dotted lines. Now, holding one side of the T, the loop is heated

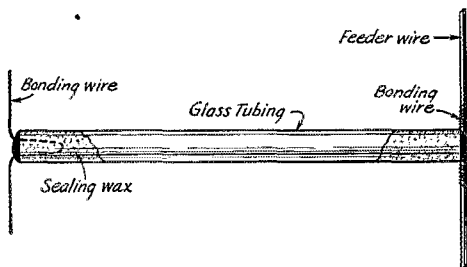

Fig. 1 -- A homemade light-weight feeder spreader made from glass tubing. The bonding wires are fastened in the ends of the tubing with sealing wax and then wrapped around the feeder wires.

over a flame and inserted in the sealing wax until the top of the T is even with the end of the glass tubing. The wire must be hot enough to insure that the wax seals to it firmly. After cooling thoroughly the end may be held momentarily over a flame to smooth it up and give a finished appearance. Care must be used to avoid getting the wax too hot, otherwise it will run out of the tube.

In use the two wires are merely twisted tightly around the feeder wires, as shown in the sketch. None used here has loosened up perceptibly as yet. The advantages of this spreader are: low cost (approximately one cent each for tubing for a 6-inch spreader); ease of construction and very light weight. A completed 6-inch spreader made of 8-mm. tubing weighs less than  $\frac{1}{2}$  ounce. The tubing can be obtained at any laboratory supply house at a list price of 50 cents per pound. 8-mm. tubing runs 24 feet to the pound. For the fastidious, Pyrex tubing may be used equally well and lists at 80 cents per pound.

The first set of these feeder spreaders was installed here six months ago and has proven perfectly satisfactory in every respect.

— Omar E. Snyder, W8QZP

## MATCHING SYSTEM FOR LOW- IMPEDANCE RADIATORS

Fig. 2 is a sketch of a feed system I am using on my rig here, which might be of interest to the gang. I have never seen it in print before, although the underlying ideas are very simple.

Having erected a four-element close-spaced beam, here at W6DSZ, we finally came down to the troublesome question of feeding it. The radiator's center impedance of only 5 ohms or so presented a problem, since we wished to use open-wire lines if possible and yet be able to rotate the beam without having to resort to slip rings or similar means. We finally hit upon the idea shown which seems to work very well.

Beginning at the antenna end, the piece of EO-1 cable is delta-matched to the antenna at the center. This cable is just long enough to pass through the center supporting shaft with enough slack to turn the beam around. The bottom end of the EO-1 cable is matched to a 600-ohm line with a standard 20-meter Johnson Q section. Of course, a home-built quarterwave section of 212 ohms surge impedance will do as well.

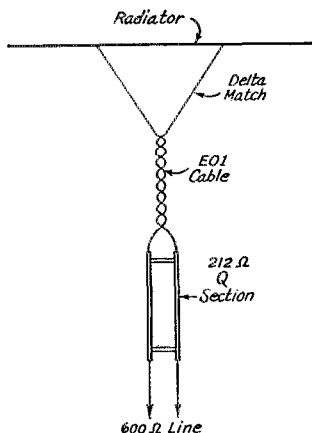

Fig. 2 — Feeding low-impedance beam radiator. In the specific case described by W6DSZ, the delta is attached 30 inches each side of the center of the 14-Mc. radiator of a four-element beam. The distance from the center of the radiator to the junction with the EO-1 cable is 60 inches.

The advantages of this system are obvious. First, since only enough EO-1 cable is used to reach through the supporting shaft, losses due to long lengths of this cable are reduced. Second, since the section that is used is operated as a flat 72-ohm line, rather than as a Q section as some systems use it, losses are further reduced to the absolute minimum possible with this type of line. In our case where only 6 feet or so is used, losses are considered negligible.

In operation, the 600-ohm part of the line shows substantially the same r.f. voltage and current along its length; the voltage falls off gradually as we progress up the Q section toward the antenna. The voltage is very low all the way up the EO-1 cable to the antenna — scarcely enough to light a 1/2-watt neon lamp even with a full kilowatt input.

We might also mention that the antenna can be rotated four times in either direction without any difficulty from feeders twisting up.

With suitable change of the Q section length and spacing of the delta match, this system could be used on any type of beam having radiation

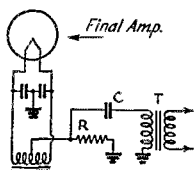

Fig. 3 — Circuit of the simple 'phone monitoring system. R — Approximately 1 per cent of the load resistance represented by plate circuit of Class-C amplifier. C — 4- $\mu$ fd., low-voltage. T — transformer with primary to suit R and secondary to suit monitoring speaker or line.

resistance less than 72 ohms and at any frequency.

— Fred Clapp, W6DSZ

### SIMPLE 'PHONE MONITORING SYSTEM

MANY of the 'phone gang will not use a monitor because of the tubes involved. Fig. 3 shows a monitoring arrangement used here which requires no tubes and certainly is O.K.

The 50-ohm primary of a small output transformer is connected across a 50-ohm resistance connected in series with the filament center tap of the final amplifier. The 4- $\mu$ fd. condenser prevents the flow of d.c. through the transformer primary winding. The secondary winding should be suitable for the monitoring device. In my case, I feed the output into a 500-ohm line to a remote speaker or headphones. My final amplifier runs at 500 watts input and I find that the 50-ohm resistance will supply sufficient voltage for monitoring.

— C. H. Haas, W6EAH

### COMPACT MULTIPLE CRYSTAL HOLDER

I HAVE just completed a simple and compact multiple crystal holder. A sketch is shown in Fig. 4. B is a strip of metal, preferably brass, 3/16 or 1/4 inch thick 1 inch wide and 6 inches long. This strip forms a common plate for one side of all crystals and the surface should be made as flat as possible. The individual top plates A are made

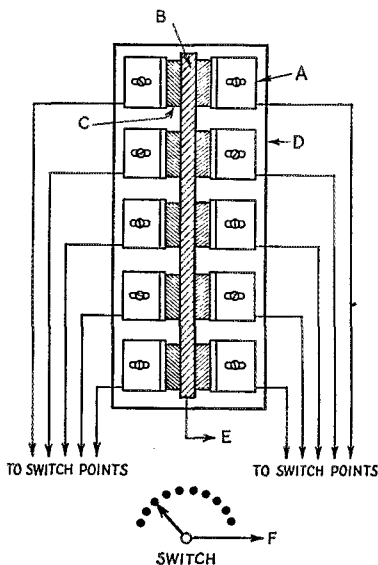

Fig. 4 — A compact multiple crystal holder. B is the contact plate common to all crystals. A indicates the individual adjustable top plates. C indicates the crystals and E and F external connections to the circuit.



from pieces of brass angle stock. The surfaces next to the crystals are also ground flat. These pieces are mounted on a sheet of bakelite, or preferably polystyrene, 3 inches wide and 6 inches long. The mounting holes are filed or drilled out to form a slot so that the positions of the top plates are adjustable. Holes for the 6-32 mounting screws are tapped in the base.

It is not necessary that the common central bar be fastened to the base. Before installing the crystals, loosen all the mounting screws and pull the two end pairs up tight against the bar and tighten the mounting screws. Then tighten up the remaining pairs in like manner. Each top plate may then be loosened up individually while inserting the crystal.

The unit is wired up as shown in the sketch, soldering the top-plate connections directly to the plates. The whole thing may be built for a few cents and will take up very little space in a crystal oven.

— Ronald Patrie, W9CWD

### SELF-BIASING SYSTEM FOR CLASS-B MODULATORS

IT IS well known that biasing systems which introduce resistance in the d.c. grid circuit of a Class-B modulator should be avoided because the variable grid current of the Class-B stage will cause a change in bias over the audio cycle resulting in non-linearity. For this reason a regulated supply or battery supply is universally recommended for Class-B applications.

It is possible, however, to filter out the variations in biasing voltage caused by changing cur-

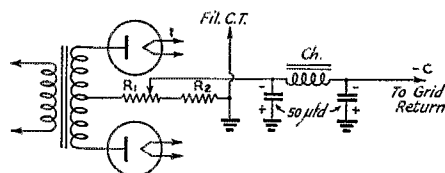

Fig. 5 — Self-biasing system for Class-B modulators. The low-pass filter in the grid lead holds the biasing voltage constant with change in cathode current. The filter is made up of an ordinary low-current choke and a pair of 50- $\mu$ fd. electrolytic condensers.

rent through a biasing resistance. Fig. 5 shows a circuit which is used frequently in commercial practice. The biasing voltage for the modulator is obtained from a variable tap on a resistance connected between filament center tap and negative high voltage. A low-pass filter is connected in series with the biasing lead to the Class-B stage.

The resistance required may be computed by Ohm's Law; it is necessary to know the total current flowing in the center tap and the desired biasing voltage. It is desirable to have a protective minimum bias and this can be provided by making part of the center-tap resistance fixed. By using a fixed resistance of 100 ohms in series with

a 150-ohm variable resistance, the resulting bias (at a center-tap current of 225 ma.) would be variable between 22.5 and 56.25 volts.

This system permits panel control of the Class-B bias and allows adjustments to be made in idle plate current of the modulator.

— Merle B. Parten, W8BWC

### Strays

Central Techno-Services, 320 Fifth Ave., New York, makes a nomographic chart called the "Vectrig Chart" which is very useful to electrical and mechanical engineers in the computation of vector quantities. Large enough to give three-place accuracy on all computations, it is only necessary to lay a straight-edge across it to convert vectors from the rectangular to the polar form or vice versa.

— . . . . .

How are you on copying on a mill? You may not know it, but if you ever expect to serve in the Navy, you'll have to know how, as all their stuff is taken down on typewriters. We think the Army is the same as far down as division organizations. We know some chaps who can read code at 40 and type at 80 but who can't copy code at over 10. Fortunately that's only because ear and hand haven't been coördinated; it yields readily to practice. It's a good thing to know how to do.

— . . . . .

If you are annoyed or your family is kept awake by the loud clicking of power-supply switches being flipped on and off, try one of the new mercury silent switches. They are made by Arrow-H & H, listed as No. 821, and others. The rating of this particular model is 5 amperes at 250 volts. They retail for 70 cents. Incidentally, these switches minimize noise in the receiver but do not entirely eliminate it. — W4BAB.

— . . . . .

For those of the gang who have beams made of tubing and are annoyed at the ungraceful curves, here's a hint. First, measure the sag of the end of the tubing in normal position. Then, put an upward bend in the tubing which will compensate for the sag. It is possible to make two 17-foot sections of type-M copper hang perfectly straight although supported for only 5 feet of the length. — W1FGO.

— . . . . .

"Push-button" b.c. sets may easily and conveniently be tuned to the i.f. of a converter by lining up one of the push-button circuits with the i.f. desired.

— . . . . .

To remove the danger of accidental contact with the adjusting screw of panel-mounted meters, cement one of National's new miniature victron coil forms, type PRC, over the screw with Duco cement. A hole in the bottom of the form will still permit adjustment of the screw if found necessary. — W7CQK.

# More on Cathode Modulation

**A 'Phone-C.W. Transmitter with Volume Compression and Adjustable Audio Response**

**BY FRANK EDMONDS,\* W2DIY**

A FLOOD of correspondence on the subject of cathode-modulated transmitters was responsible for the writer building a new rig, in which are incorporated a number of features of interest to the amateur. While it is not expected that the transmitter might be duplicated exactly, most of the ideas can be applied to any transmitter.

Before describing the transmitter, it might be well to add a little more to the story of cathode modulation as presented last month. It has been found that the audio power required for 100% cathode modulation runs around 10% of the d.c. input to the modulated amplifier, when the cathode transformer is properly matched to the

modulated stage. The cathode impedance can be approximated closely enough for all practical purposes from<sup>1</sup>

$$Z = \frac{2P}{I^2}$$

where  $Z$  = cathode impedance in ohms

$P$  = audio power in watts required for 100% modulation (10% of d.c. input to amplifier)

$I$  = the d.c. cathode current in ma. — sum of plate and grid currents

For example, with 250 watts input and a total cathode current of 190 ma., the cathode impedance works out to be

$$\frac{2 \times 25}{190^2} = 1385 \text{ ohms.}$$

\* United Transformer Corp., 150 Varick St., New York City.

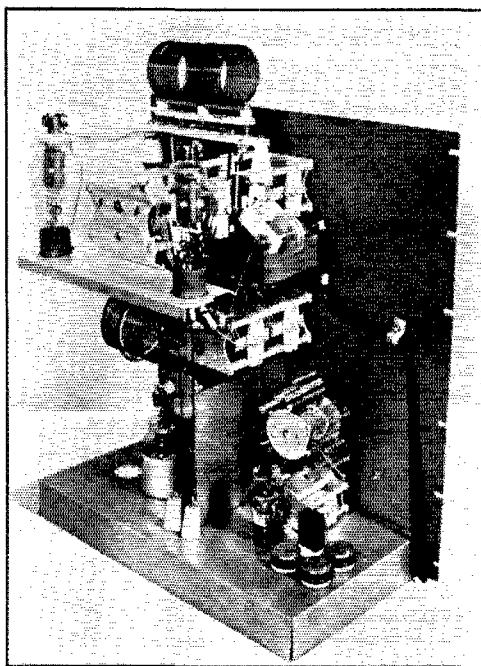

The entire r.f. assembly is mounted on a single panel. The 6V6 oscillator with hand-switching tanks can be seen at the lower right, and the 807 buffer and switched tanks can be seen at the lower left. The final grid and plate tuning condensers act as supports for the 812's and the grid and plate coils.

This panel is just one unit of the complete transmitter, which is housed in a large metal cabinet.

The match does not have to be exact, and any value close to this will be satisfactory.

It is interesting to note that the danger of parasitic oscillations is less in cathode-modulated transmitters than in plate-modulated rigs, because the peak plate voltage at 100% modulation is not a great deal higher than the average plate voltage, while under plate modulation it reaches a point twice that value. In any event, however, the amplifier must be perfectly neutralized and the modulator should be capable of furnishing the necessary power without overloading. Because the plate voltage does not rise as high, the plate tank condenser does not require the usual large spacing found in plate-modulated stages.<sup>2</sup> Condensers suitable for c.w. operation will be found to have adequate spacing.

It is, of course, just as easy to overmodulate a cathode-modulated transmitter as any other, so provision should be made for monitoring the output and limiting the audio peaks. The transmitter to be described uses a compression circuit which feeds back rectified voltage from the output of the modulator to the suppressor grid of the first speech amplifier tube, thus limiting the peak audio output and at the same time permitting a higher average percentage of modulation. Since it is possible to overmodulate even with compression, it is advisable to use visual monitoring to

<sup>1</sup> Jones, "Cathode Modulation," Pacific Radio Publishing Co.

<sup>2</sup> By removing the d.c. from across the condenser plates as described in the Dec., 1938, issue of *QST*, the spacing necessary for 'phone (and c.w.) operation can also be greatly reduced. — Ed.

avoid the radiation of side-band splatter caused by overmodulation.

The speech system of this transmitter makes use of a combination filter in the plate circuit of the second speech amplifier tube to control the overall audio frequency characteristic of the transmitter. It has been found that this filter, which acts as a high-pass low-pass or band-pass filter, effectively increases the range of the transmitter under severe QRM conditions by limiting the audio frequencies to only those useful for intelligibility. In the band-pass position, the amplifier passes audio frequencies ranging from 350 to 4200 cycles. The lower frequencies are usually lost in the QRM and the higher frequencies are not passed by the average communications-type receiver, and by transmitting only the useful frequencies, the signal appears to be louder at the receiving end. In actual working on the 3.9 Mc. band, it was found that, with the band-pass filter in, it was possible to get 5-9 reports from stations which reported less than 10% in-

Here is some more on cathode modulation which, as was predicted, has excited considerable interest. The story also points out that the power is effectively doubled by using a band-pass filter in the audio.

telligibility when the full frequency response was used. In effect, it increases the power of the transmitter two or three times, since most of the audio power goes into the low frequencies below 500 cycles in the usual system.

### The Circuit

As can be seen from the wiring diagram of the r.f. portion (Fig. 1), a band-switching exciter is used to drive a pair of 812's in the final amplifier. The exciter uses a 6V6 regenerative crystal oscillator to drive an 807 buffer-doubler. The new B & W turret assemblies are used in the plate cir-

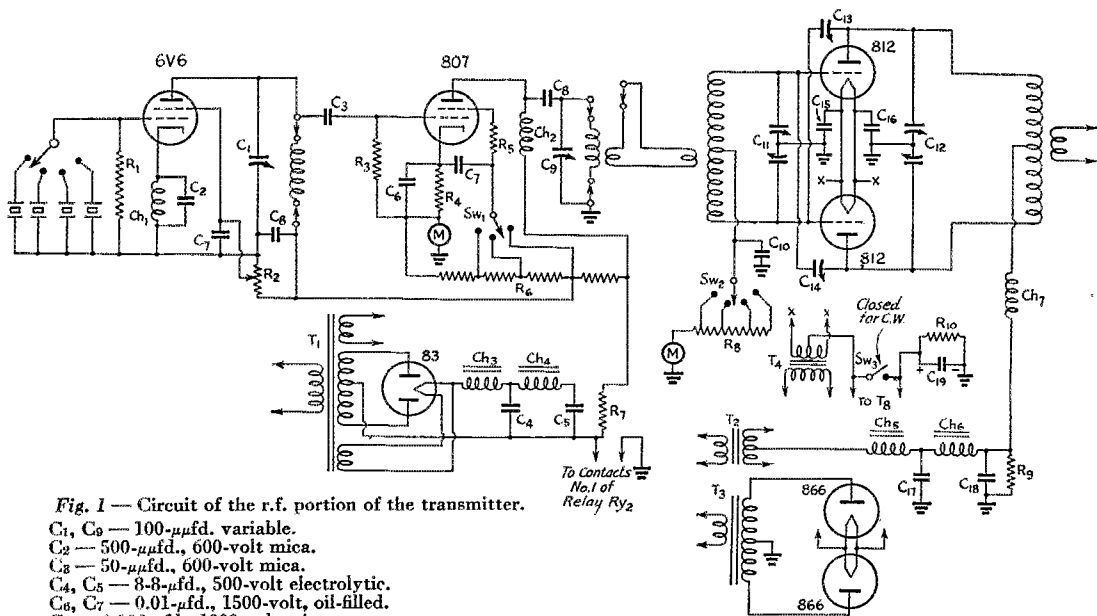

Fig. 1 — Circuit of the r.f. portion of the transmitter.

- C<sub>1</sub>, C<sub>9</sub> — 100- $\mu$ fd. variable.
- C<sub>2</sub> — 500- $\mu$ fd., 600-volt mica.
- C<sub>3</sub> — 50- $\mu$ fd., 600-volt mica.
- C<sub>4</sub>, C<sub>5</sub> — 8-8- $\mu$ fd., 500-volt electrolytic.
- C<sub>6</sub>, C<sub>7</sub> — 0.01- $\mu$ fd., 1500-volt, oil-filled.
- C<sub>8</sub> — 0.002- $\mu$ fd., 1000-volt mica.
- C<sub>10</sub> — 1- $\mu$ fd., 600-volt, oil-filled.
- C<sub>11</sub> — 150- $\mu$ fd. per section dual variable.
- C<sub>12</sub> — 100- $\mu$ fd. per section dual variable, 0.07-inch spacing.
- C<sub>13</sub>, C<sub>14</sub> — 10- $\mu$ fd. neutralizing condensers.
- C<sub>15</sub>, C<sub>16</sub> — 0.001- $\mu$ fd., 1000-volt mica.
- C<sub>17</sub>, C<sub>18</sub> — 4- $\mu$ fd., 1500-volt filter condensers.
- C<sub>19</sub> — 8- $\mu$ fd., 100-volt electrolytic.
- CH<sub>1</sub>, CH<sub>2</sub> — 2.5-mh., 125-ma. r.f. choke.
- CH<sub>3</sub> — 5-25-henry input choke, 175 ma. (S-30).
- CH<sub>4</sub> — 10-henry, 175-Ma. filter choke (S-29).
- CH<sub>5</sub> — 5-25-henry input choke, 300 ma. (S-34).
- CH<sub>6</sub> — 20-henry, 300-ma. filter choke (S-33).
- CH<sub>7</sub> — 500-ma. r.f. choke.
- R<sub>1</sub> — 50,000 ohms, 1-watt.
- R<sub>2</sub> — 25,000 ohms, 25-watt bleeder.
- R<sub>3</sub> — 50,000 ohms, 2-watt.

- R<sub>4</sub> — 200 ohms, 10-watt.
- R<sub>5</sub> — 100 ohms, 1-watt.
- R<sub>6</sub> — 25,000 ohms, 50-watt, tapped every 5000 ohms.
- R<sub>7</sub> — 30,000 ohms, 50-watt bleeder.
- R<sub>8</sub> — One 10,000-ohm and ten 2000-ohm, 20-watt in series.
- R<sub>9</sub> — 50,000-ohm, 10-watt bleeder.
- R<sub>10</sub> — 100 ohms, 50-watt.
- T<sub>1</sub> — 500 volts at 175 ma., plus filament windings (S-39)
- T<sub>2</sub> — 2.5 volts at 10 amperes (S-57).
- T<sub>3</sub> — 1500 volts at 300 ma. a.c. (S-47).
- T<sub>4</sub> — 6.3 volts at 9 amperes (S-61).
- SW<sub>1</sub> — Single-circuit 4-position switch.
- SW<sub>2</sub> — Single-circuit 10-position switch.
- SW<sub>3</sub> — S.p.s.t. toggle.

(Figures in parenthesis refer to UTC type numbers.)

cuits of both tubes, permitting immediate switching to any band from 160 to 10 meters. The crystals are also switched, to expedite the band-changing operation.

The final amplifier (push-pull 812's) seems to be very easy to drive. It requires approximately 15 watts drive for c.w. operation and from 6 to 10 watts on 'phone, with cathode modulation. The measured output is 200 watts on c.w. and 140 watts on 'phone, at a plate input of 247 watts (190 ma. at 1300 volts). At this input, the grid current for the cathode-modulated amplifier was 10 ma.

For c.w. operation, the bias resistance is decreased to 10,000 ohms and the grid drive is increased. Switching allows ready adjustment of the grid-bias resistance, and another switch controls the output of the 807 driver by selecting the proper voltage on the divider that supplies the 807 screen grid. The variable grid-bias resistor is made up of one 10,000-ohm and ten 2000-ohm, 10-watt resistors and a conventional rotary tap switch. Since the bias voltage developed is fairly high, the a.f. grid by-pass condenser  $C_{10}$  should at least be rated at 600 volts. As mentioned in the article last month, the antenna loading must be quite heavy, as in the case of a Class-B linear amplifier. As the loading is increased, the antenna current will increase up to a certain point and beyond that it will fall off. A point just beyond maximum will give the best modulation linearity.

The audio requirements of the transmitter are quite low, and a pair of 6L6's furnishes plenty of audio to modulate completely the quarter-kilowatt input. Two input channels through 6J7's are available, to avoid the necessity for passing the microphone around the room when guests are present in the shack. The two inputs are mixed in a 6N7 which works, through the band-pass filter, into a pair of 6C5's used to drive the 6L6's. For volume compression, power from the output of the 6L6's is rectified by a 6H6 and used to control the suppressor grids of the 6J7 input tubes. The amount of

(Continued on page 87)

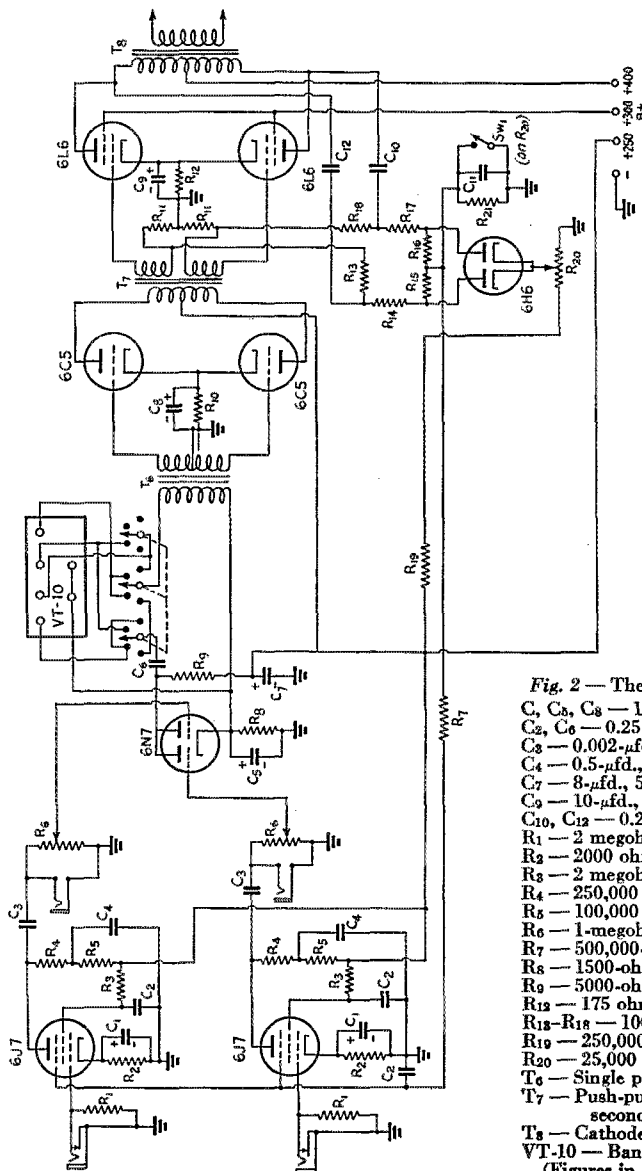
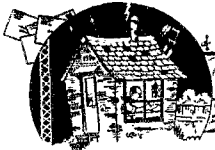

Fig. 2 — The speech amplifier and modulator circuit.

- $C_1, C_3, C_8$  — 10- $\mu$ fd., 250-volt electrolytic.
  - $C_2, C_6$  — 0.25- $\mu$ fd., 400-volt tubular.
  - $C_3$  — 0.002- $\mu$ fd., 400-volt tubular.
  - $C_4$  — 0.5- $\mu$ fd., 400-volt.
  - $C_7$  — 8- $\mu$ fd., 500-volt electrolytic.
  - $C_9$  — 10- $\mu$ fd., 50-volt electrolytic.
  - $C_{10}, C_{12}$  — 0.25- $\mu$ fd., 400-volt.  $C_{11}$  — 1- $\mu$ fd., 400-volt.
  - $R_1$  — 2 megohms,  $\frac{1}{2}$ -watt.
  - $R_2$  — 2000 ohms,  $\frac{1}{2}$ -watt.
  - $R_3$  — 2 megohms,  $\frac{1}{2}$ -watt.
  - $R_4$  — 250,000 ohms,  $\frac{1}{2}$ -watt.
  - $R_5$  — 100,000 ohms,  $\frac{1}{2}$ -watt.
  - $R_6$  — 1-megohm potentiometer.
  - $R_7$  — 500,000-ohm,  $\frac{1}{2}$ -watt.
  - $R_8$  — 1500-ohm, 1-watt.  $R_{10}$  — 600 ohms, 1-watt.
  - $R_9$  — 5000-ohm, 1-watt.  $R_{11}$  — 10,000 ohms,  $\frac{1}{2}$ -watt.
  - $R_{12}$  — 175 ohms, 20-watt.
  - $R_{13}-R_{18}$  — 100,000 ohms,  $\frac{1}{2}$ -watt.
  - $R_{19}$  — 250,000 ohms,  $\frac{1}{2}$ -watt.
  - $R_{20}$  — 25,000 ohms,  $\frac{1}{2}$ -watt.
  - $T_6$  — Single plate to push-pull grids.
  - $T_7$  — Push-pull plates to push-pull grids, with split secondary.
  - $T_8$  — Cathode-modulation transformer (CM-16).
  - VT-10 — Band-pass filter (VT-10).
- (Figures in parenthesis refer to UTC type numbers.)



# CORRESPONDENCE FROM MEMBERS

The Publishers of *QST* assume no responsibility for statements made herein by correspondents

## MORE S.F. TRIBUTE

Route 3, Cenoka, Minn.

Editor, *QST*:

In your October, 1939, issue . . . you have written an article headed "Farewell, S.F. System," where you state that there were originally three S.F. stations, of which one was W1XP of M.L.T.

On page 42 of your May issue of 1930 you will note that there were then two stations, namely, W1AXV and W9XL. Being one of the operators of the latter, and knowing the time and labor given gratis by these men, I think it only fair that this station be mentioned.

— Ivan H. Anderson, Supervisor of WCCO Transmitter

**Edron's Note.**— Mr. Anderson goes back farther than we did, but the things he says about W9XL's work are none-the-less true. W9XL and W1AXV pioneered amateur-band standard frequency transmissions under the Official Frequency Station Committee, a part of the A.R.R.L. Experimenter's Section. This committee included Don C. Wallace, W6AM, chairman, Prof. C. M. Jansky, Jr., and Killian V. R. Lansingh, W6QX. W6QX was in charge of the Standard Frequency Transmissions. This system was the forerunner of the W1XP-W9XAN-W6XK triumvirate which comprised the A.R.R.L. Standard Frequency System referred to in the editorial. The splendid pioneering work of W9XL and W1AXV cannot be praised too highly.

## BLACKOUT

178-15 Henley Road, Jamaica, L. I., N. Y.

Editor, *QST*:

. . . I couldn't let this opportunity go by without writing to express to you my thanks and to offer you my heartiest congratulations on your editorial in the October *QST* under the heading "Blackout." To me you have expressed the inner thoughts of all good amateurs. Something must have inspired you to write such an understanding article. All of us, I am sure — and I know I am speaking my own thoughts at the moment — feel, as you have so aptly put it, that this amateur game of ours is something much finer than just another QSO, and not even war can take away the inner feeling that we have for all of our friends, who are guided undoubtedly against their wishes to do the things they know inside themselves should not be done. Our radio friendships . . . are something we can all treasure, and we hope that some day all this trouble will be forgotten, and that we shall again be able to continue with our contacts in the greatest of all hobbies, one that knows no boundary lines. . . .

— Reese O. Strock, W2GTZ

29 Kechill Gdns., Mayes, Bromley, Kent, England  
Editor, *QST*:

May I take this opportunity to congratulate you on your magnificent editorial in October *QST*.

I am sure that it represents the feelings of hams in all countries whatever their nationality. As you say, the ham when caught up in the wickedness of war is expected to kill his friends — not just semi-mystical people who merely appear in the columns of his daily newspaper, but real people who talk and who have come into his own home.

We are the pioneers of a new world outlook wherever we may be.

A word to my many friends in the new world: You are the custodians of a great trust for the amateurs of the rest of the world. Keep our bands open for us, and if anyone gate-crashes on them with war as the excuse, keep them out whoever they are!

— Arthur O. Milne, G2MI

## CATHODE MODULATION

15 East 49th St., New York, N. Y.

Editor, *QST*:

The introduction to the article on cathode modulation, appearing on page 23 of the October, 1939, issue of *QST*, strikes the writers as being slightly funny. The "bushel" that cathode modulation has been hiding its light under has been very small indeed. If you will look back over your files you will find, under date of July 28, 1937, a letter from us outlining our progress in experimenting with a cathode-modulated transmitter and the success achieved in our work.

In this letter we pointed out that although we had applied cathode modulation only to an oscillator, we saw no reason why similar results could not be had in modulating an r.f. amplifier.

You replied promptly under date of August 3, 1937, and stated you were setting up a duplicate transmitter for test. You further stated that the circuit was originated by us, at least as far as *QST* was concerned, and suggested that we write up and forward to you a complete description in article form for possible publication.

The article was duly written, and forwarded to you under date of August 5, 1937. The article was finally published in *QST* of February, 1938.

As you probably know, F. C. Jones has just published a comprehensive book titled "Cathode Modulation." In the publisher's introduction great pains are taken to point out that, in a publication of 1934, "Five Meter Radiotelephony," Jones first introduced cathode modulation by means of inserting a carbon mike in the cathode circuit of a tube. Upon perusing these publications, we find that he did insert a mike in the filament (cathode) circuit of a transceiver using a 19 tube, but apparently he did not realize this himself as this is shown only in the diagram and in the text he consistently refers to grid modulation. In view of this evidence, it is plain that we were the originators of both the name and the method of application of cathode modulation.

Yours sincerely,

—Everett C. Geiger, W2FZQ  
Edward McGrath, W2GNL

## B.C.L. QRM—WHOSE FAULT?

2153 West 111th St., Chicago, Ill.

Editor, *QST*:

Received my ORS/OPS bulletin to-day, and the article pertaining to b.c.l. QRM generated the necessary pound of steam to cause my safety valve to blow and make a request that some action be taken by the members of the League regarding the matter. . . . Action is necessary, that is evident. There has been too much talk about how much b.c.l. QRM there is, and suggested gadgets to bring the selectivity or rejection characteristics of the so-called "modern" receiver of to-day to a point where interference from amateurs is eliminated. In some cases the ham is at fault, no doubt; but I believe I am safe in saying that in 90 per cent of the cases it is the fault of the receiver the b.c.l. is using.

Why does A.R.R.L. Headquarters keep harping on "b.c.l. QRM caused by amateurs" and especially the 160-meter 'phone gang? Why not get at the source of the trouble — "b.c.l. trouble caused by the manufacture of b.c.l. sets to meet a price, not quality"?

A.R.R.L. has the backing of enough members to bring about a petition, or what have you to suggest, to cause action that will force all manufacturers to meet a certain standard. If the present receivers advertised and sold as the "ultra" in b.c.l. receivers aren't evidence of misrepresentation carried to the Nth degree, what is?

(Continued on page 82)



# NAVAL COMMUNICATION RESERVE NOTES

## The Twelfth Naval District

BY LIEUT. COMDR. SYDNEY J. FASS, U.S.N.R. (N6NZ)

AN EXCELLENT article on the Naval Communication Reserve of the Twelfth Naval District appeared in the January, 1939, issue of this magazine. Several changes have been made in organization and personnel since then and are here noted.

Lieut. Comdr. Henry K. Huppert, U.S.N.R., N6NV, assumed command of the Naval Communication Reserve of the Twelfth Naval District last fall. As his Executive Officer he selected Lieut. Wilfred Munter, U.S.N.R., N6DAA. Lieut. Comdr. Huppert is a veteran of the N.C.R. and has had command of various units and sections prior to his assumption of his present office.

This district was formerly divided into ten sections, geographically, each headed by a section commander. This number has been reduced to seven; with a total of twenty-six units, or subdivisions. In this way the work of the section and unit commanders will be more evenly distributed.

Inasmuch as other articles in the magazine have dealt with organization, etc., it might be more interesting to tell of some of the unusual events that have been participated in by the members of the Naval Communication Reserve of this district.

For several years past, the Navy Department has held a national N.C.R. competition amongst the various naval districts. This competition consists of several factors, in which all personnel have an active part. A silver cup is the prize, and permanent possession of it goes to the district that wins it three times in a succession. The N.C.R. of this district won the first cup and it is proudly displayed at headquarters. On September 22nd the Commandant of this district presented the second cup to our officers and men for win-

ning the competition for the season of 1938-39. This was also won in the 1937-38 season and the winning of it for the present season would again give this district permanent possession.

About four years ago a schedule was initiated in this district which has proven very popular. This is known as the "Fox Schedule." NPG, the regular navy radio station, in San Francisco sends, for thirty minutes prior to the Tuesday evening drills, a broadcast to all members of the Naval Communication Reserve in this district, giving news and information of general

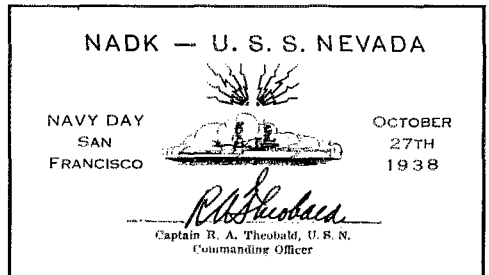

QSL card sent from the U.S.S. Nevada last Navy Day, Oct. 27, 1938. Sent only to N.C.R. members of the 12th Naval District worked.

interest as well as occasional problems, etc. All personnel in the district copy this schedule.

Every year, during the Labor Day holidays, a three-day meeting is held at some point convenient to the majority of the officers. This event is known as "The Officers' Yearly Conference." This year the meeting was held in and around San Francisco. On Saturday evening a regular "navy chow" was had by the officers and their ladies at Yerba Buena Island, the naval station in San Francisco Bay, which was followed by a dance at the Army and Navy Club in the Fairmont Hotel, San Francisco. The following day, Sunday, was Naval Communication Reserve Day at the Golden Gate International Exposit-



Lieut. Comdr. Huppert, N6NV presents Stuart Ayres, W6GEA, manager of W6USA, with the Navy Certificate while Lieut. Comdr. Fass, N6NZ, Officer of the Day, looks on. Also in the photo are Bob Hanson, W6MPC, the operator at W6USA; Lieut. Munter, N6DAA; Ensign Geritz, N6CTX and other officers and men of the N.C.R., most of whom are active amateurs.



QSL card sent from the Exposition on Naval Communication Reserve Day, Sept. 3, 1939.

tion, to which all officers and men were invited with their families. Arrangements were made for free admission to all who were in naval uniform. Several special events were planned. The de-luxe exposition amateur station, W6USA, was taken over by the N.C.R. and manned by it. All stations worked were sent a special QSL card with the call N6USA on it. Several hundred of our people attended and had an enjoyable day. Monday, the officers held their conference and the problems of the Reserve were discussed. An excellent address was made by Lieut. Comdr. Huppert, who told of the competition, drills, educational program, etc., for the coming season. The meeting was adjourned early so that those who desired could attend the A.R.R.L. convention in San Francisco.

On Navy Day (October 27th) for the past several years an unusual radio exercise has been conducted in this district. The Navy Department gives special permission to the N.C.R. stations in this district to communicate with a naval station, either aboard ship or ashore. The N.C.R. transmits on their unit frequencies and the navy station works on a naval frequency. Last year, one transmitter and three receivers were in continuous use on the U.S.S. *Nevada* during the period from 4 P.M. to 10 P.M. N.C.R. messages are in the form of greetings to friends in the service, or to the officers and crew of the ship

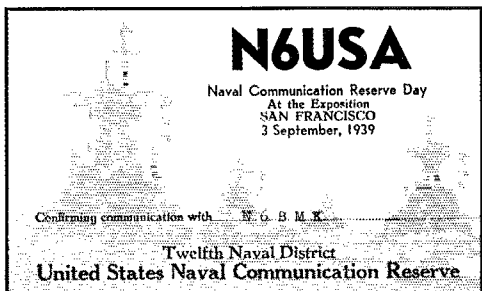

QSL card sent from NPG this Navy Day, Oct. 27, 1939, to members of the N.C.R. worked.

or station worked. Each message contains the name and address of the originator so that a special QSL card can be mailed to everyone worked. There being no naval vessels in San Francisco Bay this year, NPG, Radio San Francisco is to be the contact. This exercise has been very popular and over 130 stations were worked last Navy Day. This exercise, of course, in no way supplants the message to amateurs from the Secretary of the Navy which is copied by most of the N.C.R.

The N.C.R. has striven to make its organization comparable to the highly efficient United States Navy. The slogan of the organization is "Preparation in time of peace, so that we may take our place in the regular service with honor in case of necessity."

## More On Cathode Modulation

(Continued from page 54)

compression is controlled by adjustment of resistor R20. Degeneration is included in the 6L6 modulator stage for better audio quality.

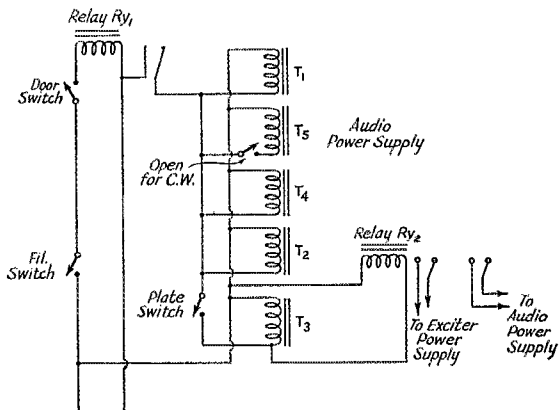

Fig. 3—Circuit of the transformer primaries, showing where the interlock switch is connected and how relay R1 is used to break the total current instead of the filament switch.

For safety, all of the power supplies are tied into an interlock switch that opens when the door of the cabinet is opened. All meters are mounted behind a plate glass window, and a tubular frosted lamp mounted above the inside of the meter panel provides indirect illumination of the meters without glare. All power transformers and high-voltage condensers are mounted with their terminals below the chassis to lessen the possibility of accidental contact.

# ★ I. A. R. U. NEWS ★

Devoted to the interests and activities of the

## INTERNATIONAL AMATEUR RADIO UNION

Headquarters Society: THE AMERICAN RADIO RELAY LEAGUE, West Hartford, Conn.

### MEMBER SOCIETIES

American Radio Relay League  
Asociatia Amatorilor Romani de Unde  
Scurte  
Associazione Radiotecnica Italiana  
Canadian Section A.R.R.L.  
Ceskoslovenski Amatéri Vysilaci  
Deutscher Amateur Sende-und-Empfangs  
Dienst  
Eesti Raadio Amatooride Uhing  
Experimental Radio Society of Egypt  
Experimenterende Danske Radioamatorer  
Federation des Emetteurs Belges  
Irish Radio Transmitters Society

日本アマチュア無線聯盟 Japan  
Liga Colombiana de Radio Aficionados  
Liga Mexicana de Radio Experimentadores  
Magyar Rövidhullámú Amatőrök Országos  
Egyesülete  
Nederlandsche Vereeniging voor Interna-  
tionaal Radioamateurisme  
Nederlandsch-Indische Vereeniging Voor  
International Radioamateurisme  
Newfoundland Amateur Radio Association  
New Zealand Association of Radio Trans-  
mitters  
Norsk Radio Relæ Liga

Polski Związek Krotkofalowcow  
Radio Club de Cuba  
Radio Club Venezolano  
Radio Society of Great Britain  
Rede dos Emissores Portugueses  
Reseau des Emetteurs Français  
Reseau Luxembourgeois des Ama-  
teurs d'Ondes Courtes  
South African Radio Relay League  
Suomen Radioamatöörlitto r.y.  
Sveriges Sändareamatörer  
Unión de Radioemisores Españoles  
Union Schweiz Kurzwellen Amateure  
Wireless Institute of Australia

### WAR ECHOES

#### South Africa

Perhaps it was too good to last. At any rate, ZS amateurs were closed down October 29th, and spent a busy evening that date saying good-bye to their many friends on the air. At the moment no official word has been received as to whether or not there was any timely event which precipitated the action, but it is logical to believe it is for the same reason that has caused shut-downs in every belligerent country (except Germany). The cessation of amateur radio activity is now complete in every part of the British Empire.

G. Ross Kent, ZS6L, vice-president of S.A.R.R.L., sent the following note to Union headquarters the day before the deadline: "We go off the air tomorrow so we take this opportunity of sending greetings to all amateurs and of wishing them good luck, long life and 73 until we meet again."

#### Germany

The D.A.S.D.'s Secretary, H. von Bulow, has volunteered his services, leaving B. Garnatz, D4AQF, formerly manager of the QSL and licensing departments, in charge. All publications of the society have been suspended until further notice excepting "CQ," which is expected to appear, in decreased size, every other month. Meetings of local clubs have been discontinued. A special D.A.S.D. bulletin says:

"Each executive and each member of the D.A.S.D. shall do everything in his power to maintain contact with the other D.A.S.D. comrades, whenever possible, thereby keeping the foundation of the organization intact. It is expected of every D.A.S.D. member that he makes

available his knowledge and ability, as well as the apparatus and material at his disposal, and fulfill the duty assigned to him by his superiors."

#### France

It is disheartening to learn that since mobilization called into the services many of their executive and administrative staff, including the editor of "Radio REF," the *Reseau des Emetteurs Français* decided the only possible action open to it was discontinuance of all activities. May it, and its cause, be not for long! The society is now completely closed down; publication of supplies and the official journal has ceased; the QSL Bureau is no longer functioning (interested amateurs should note cards can no longer be successfully routed via the bureau system).

#### Australia

The W.I.A. is making every effort to continue its normal activities, including meetings, at which receiving problems and allied subjects will be given principal attention. Here, again, amateurs are serving their country; not only have those amateurs affiliated with the air force wireless reserve reported for active duty, but the amateur society has offered the services of its remaining operators to the P.M.G. Department for monitoring purposes, should they be desired. If the proposal is accepted, each division will undertake to monitor a portion of the short-wave spectrum. In addition, code classes are being offered by the New South Wales Division to improve the operating abilities of members.

#### Cuba

It seems that Cuban amateurs are not the only members of the radio groups in that country



to experience trouble with authorities. Five commercial broadcast stations, with possibilities of a number of others, are also closed down, because of frequency variation and use of excessive power which caused interference to other services. In the case of amateurs, the suspension period will on November 9th have completed its second month, the maximum length of time prescribed in the decree ordering the suspension. We hope and expect to hear amateurs in Cuba back on the air by that time.

### Great Britain

To crush any mythical "spy" they fear might exist in the amateur ranks, government authorities have subjected their licensed amateurs to the inconvenience, not to mention the financial loss, of confiscation. The R.S.G.B. believes that the post-office department handling amateur matters would have been content to just seal up the equipment, but higher officials decreed otherwise — and in a great hurry in the bargain; consequently, in many cases unskilled and non-radio men had to be sent out to recover the gear. This resulted in a first-class muddle; some of the fellows had their stations nearly wrecked, while others experienced only the loss of a part or two. Some received receipts for their equipment; others did not. Such is war. . . . But with something over 2000 stations licensed, the G.P.O. certainly undertook a formidable task. Imagine the apparatus in your own station multiplied 2000 times!

The executive order terminating English licenses as of September 1st applied to the "artificial aerial" stations as well. Receiving equipment may still be used by any person. Television stations of the B.B.C. have been closed. The rush to purchase b.c. receivers has been extraordinary; the number of receiving licenses increased some 25,000 in September. A large number of R.S.G.B. members have gone into the services, and the October issue of the Society's journal carries a list of those serving with the armed forces.

The G's are determined to apply to experimental and development work the time formerly spent on operating. To take care of the demand for technical literature, the society has just reprinted a supply of its "Amateur Radio Handbook." (See page 92, February *QST*.) Any amateur would enjoy this book; the price is 2/6, post-paid.

### Denmark

On August 26th, the directorate general of radio granted amateurs the frequencies 1805-20 kc., climaxing a long fight by the E.D.R. to secure a small 160-meter band instead of the three former spot channels of 1730, 1830 and 1970 kc. We hope our OZ friends will be as fortunate when the present ban on all transmitting is lifted (they were closed Oct. 1st), as the battle may have to be fought all over again.

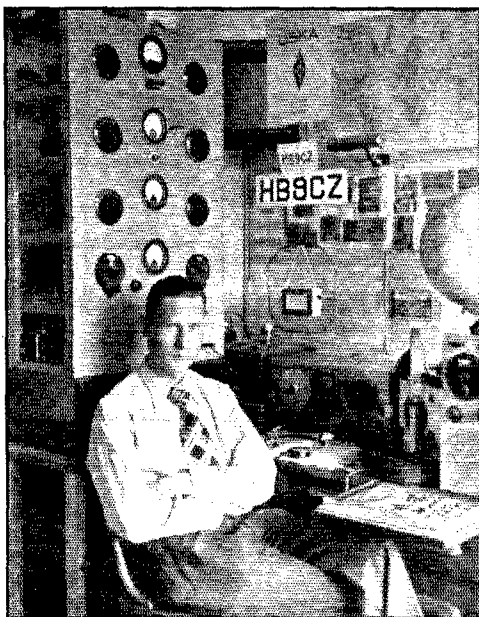

Hans Baeni, HB9CZ with his eye on a DX CC certificate, worked 82 countries before Swiss amateurs were closed down.

### Ireland

Although Ireland is neutral, EI amateur licenses were revoked on September 1st, and P. & T. Department officials ordered the civic guards to seize all transmitting apparatus immediately, which resulted in all-night activity. Amateurs had to pack their gear at a moment's notice, with no concern allowed for tubes, meters, etc. I.R.T.S. has appointed a committee to contact authorities regarding suitable protection of their apparatus in storage and packing. A second "emergency" committee has been formed to handle the affairs of the society. The society terminated its affiliation with the B.E.R.U., since there were several Irish amateurs who refused to join the I.R.T.S. on that account, and it was felt that at the present time nothing should stand in the way of national unity.

Peter Daly, formerly EI5G, presents some interesting sidelights on the situation. . . . "Conditions have been remarkably good and signals from the Antipodes have been rollicking in — they would! It's curious to think that a short month ago we were engaged in friendly competition with the D's in their annual contest — what a pity it is that statesmen can't take a leaf from the radio amateur's book. . . . Isn't it a bit of a come-down to have to become a short-wave listener once more? Staunch old S.W.L.s are going to have a good old laugh at us. Neverthe-

(Continued on page 86)



The **A.R.R.L. Copying Bee** is scheduled for Friday evening, December 8th. The transmitting station lineup is arranged to cover the country well, by location of the stations in different sections geographically, and by a wide selection of frequencies. If you are not satisfied with the first copy from the first station heard, continue to try for other Copying Bee stations . . . different texts of equal length and difficulty will be sent at hourly intervals during the evening. Give it a whirl, and *send in what you receive*. In due course you will get your copy back with the correct texts. The Bee is an established activity, a chance to test our hearing and ability to write down what we hear, a stimulus toward copying accuracy enabling us to get a private idea of our personal proficiency. The Bee is open to all amateurs. It is a whale of a lot of *fun*. Mark your calendar now. Try it, in line with the detailed announcement elsewhere in this issue, and let us hear from you. "Bee" in on the Bee!

The **U.H.F. Contest** (November) was a bushel of fun, full of thrills and surprises for all. While too early to hear from the whole country, reports are pouring in, as we go to press. There were dozens of successful multi-hop relays. In the northeastern part of the country the gang was favored with all kinds of u.h.f. weather, good consistent DX signals Saturday evening followed by a relapse, and then a big surprise — a break through between the 9th district and the east coast! W1HDQ will have some highlights by next issue, and we'll be pasting copies of messages into continuous chains to show routings for at least the next month before the whole story can be told. The forming of relay routes is coming on fine, and the old romance of the u.h.f. possibilities to be explored is right there, with the unexpected around the corner adding a lot of zip to this particular party.

Congrats to W9WYX and W9VTK on extension of the previous 112-Mc. Colorado record. This band is coming right to the front. See details of the 160-mile, 112-Mc. work elsewhere in this *QST*.

**Surveillance!** Last month we urgently recommended that all amateurs avoid any two-way work with amateur stations in the theatre of war, and especially avoid having contacts with stations *located in belligerent countries*, in whatever continents! We renew that recommendation. Our neutrality code must be carefully observed, and we should go beyond it, to avoid the possibility of any slightest suspicion being directed against our amateur radio. Since amateurs in foreign belliger-

ent countries are practically without exception off the air, this avoidance of work with un-neutral, as well as all unlicensed, unauthorized stations, should be easy. We hear no further reports of direct invitations to violate our neutrality code such as were mentioned last month in the case of the D's and F's heard trying to work W's.

As mentioned last month, *there is surveillance*. Just as a reminder we ought to mention that a Pennsylvania amateur reported an investigation of his legitimate operating in an A.R.R.L. activity, by local police, at the teletyped request of the Coast Guard! With several government agencies on the job guarding every phase of this country's neutrality every hour of the day, it is but natural that some of our normal, individual, and quite-in-order radio activity will be checked from time to time. It is our job to see that regulations of the F.C.C. are most carefully observed, that our log is scrupulously correct, that any one of us can stand any kind of inspection at any time, and pass with flying colors, in such a way that the full *responsibility* and trustworthiness of each individual amateur is emphasized. Re-read the details of the F.C.C. warning in November *QST*, if you missed that. Each operator who reads these lines can help, not only watching his own conversations, but advising other operators at once against any irresponsible or unwise actions, whether just talk about the war (taboo), or a positive violation of the A.R.R.L. Neutrality Code or our F.C.C. regulations for the amateur service.

**A.R.R.L. Official Observers** are now of four kinds, examined and classified by their SCMs for the type of work in which they engage. Those who receive their helpful advice and reports on A.R.R.L. forms may note a Roman numeral designation, after the signature of the Observer. This indicates the class of Observer sending you the report. The established classes are as follows:

- I. Precise frequency checking.
- II. General Frequency Checks and Harmonic Measurements (to  $\pm 5$  kc. at 14 Mc.)
- III. Radiotelephone Checks of Modulation, Frequency Stability, and/or Quality.
- IV. Poor signal checking, for notes, broadness, etc. (c.w.)

No individual without a 100 kc. or comparable standard with multivibrator for direct calibrations on WWV may be considered by his S.C.M. for appointment as Class I Observer. Furthermore, both Class I and II Observers are obliged to report on at least one transmission measurement of several pre-scheduled transmissions of accurately known frequencies, after the fashion

of a former frequency measuring test, to demonstrate continued accuracy and proficiency, within prescribed standards for their O.O. Classification. New observers must pass such a test to qualify. By January 1, 1940, the A.R.R.L. Official Observers all will be on the new footing, requiring extremely high standards of equipment and performance for making checks. August *QST* (page 62) listed the amateurs who specialize in giving assistance to other amateurs through observations and measurements. They will be pleased to have you call upon them for a measurement schedule or other information with the scope of their particular duties as specified in one of the above categories. "Friendly service to brother amateurs" is the watchword of the individual A.R.R.L. Observers.

— F. E. H.

### PRIZES FOR BEST ARTICLE

The article by Mr. George E. Starek, W9RCC \* wins the C.D. article contest prize this month.

Each month we print the most interesting and valuable article received marked "for the C.D. contest." Contributions may be on any phase of amateur operating or communication activity (DX, 'phone, traffic, rag-chewing, clubs, fraternalism, etc.) which adds constructively to amateur organization work. Prize winners may select a 1940 bound *Handbook*, *QST*, Binder and League Emblem, six logs, eight pads radiogram blanks, DX Map and three pads or any other combination of A.R.R.L. supplies of equivalent value. Try your luck. Send your contribution to-day.

## "How's Your QSO Personality?"

BY GEORGE E. STAREK, W9RCC\*

**A**DDING that personal touch to a QSO means the difference between a very enjoyable contact and the "rubber stamp" type.

Noting that my QSOs were falling into the routine "cut and dried" class, I realized something had to be done to sustain not only my interest in contacting other stations, but also to keep the other fellow on the opposite end as interested and absorbed in the contact as much as possible.

What was wrong?

Evidently I had not learned proper operating procedure. With this idea in mind, I proceeded to find the cause of my dull and uninteresting contacts.

Some obvious causes that were weakening the effectiveness of my contacts were unearthed during the process of investigation.

In order of their importance, they were:

(a) The time devoted to each contact was altogether too short. My log revealed the length of time spent on each contact averaged eight minutes. I reasoned that a contact cannot be called pleasant and enjoyable if only from five to ten minutes are given to each QSO.

(b) My fist was either too fast or too slow. I also knew that during certain QSOs, my fist was terrible because the bug I was using was *adjusted too fast* for my naturally slow

\* 1341 Douglas Avenue, Racine, Wis.

fist. I attributed this fact mostly to carelessness and negligence on my part. A slight touch of inferiority complex or vanity aided me in making a mess out of what looked like a good old-fashioned rag-chew.

(c) My ability to chat interestingly was practically nil. This fact has always been and still is a thorn in my side.

Now that I had gathered together these faults which were undermining my contacts, I planned new methods of approach which later proved to be startling and very surprising.

Opening a QSO with a new station, I would greet him by referring to him by his name. (My call-book did the trick.) This invariably caused my newly-made friend to ask me what my name was, and if we had ever made a contact before. Evidently this intimate touch seems to break down the strain of formality which is predominant in so many amateur radio contacts of today.

Secondly, I would ask for complete data regarding his station. Following that, I would usually confine my queries toward one particular object. For example, his transmitter. Many times I could detect traces of restrained pride as my friend extolled the virtues of his pet transmitter; how he "worked" that choice DX last week with only 8 watts input! Here was the logical place for congratulations and words of encouragement.

Utilizing your personality to advantage, an interesting chat can be had by discovering what the other fellow's technical problems were, so that by comparing pet theories the obvious cause could be determined more easily. This fact proved somewhat surprising to say the least. Especially so, was this evident in the cases of most of the newly licensed fellows. Many of them took advantage of the opportunity to release their unsolved difficulties. The object of this problematic discussion, I believe, is to show that you are genuinely interested in him.

Trying faithfully to correct my poor operating technique and being thoroughly convinced I was not the fastest operator in the world, I regretfully moved the weights of the Mac Key back to approximately 15 w.p.m. From this point I started to learn the correct way to use a high-speed key, sending slowly and as evenly as I could. Obviously, the only way to acquire a good fist is to begin sending slowly. It must be remembered that as the sending speed is increased, the number of operators who can copy your speed is decreased proportionally.

I have also acquired the habit of asking the other fellow what his occupation was, his age, what his favorite meal consisted of and, in fact, all the trivial things that go to make up his everyday life. This may sound too personal to some, but try it once and note how quickly the feeling of the contact will develop into a warmer and more cordial one.

Especially during the past year and a half, have I really enjoyed amateur radio. My contacts have added a sparkle and an eager anticipation that I had not known existed at one time.

Amateur radio contacts provide some of the greatest thrills and offer genuine pleasure to those who know how to put their personality into a QSO. It isn't difficult, really it isn't. . . .

### BRIEFS

The Tu-Boro Radio Club (Woodhaven, L. I., N. Y.) has had a number of interesting meetings this season, and just held a successful 5th annual club dinner on November 18th. The Club Station, formerly W2JIQ, has now received the call W2BMW, in memory of Jerome Dodman, one of the founders of the club.

### Visit the Clubs

At A.R.R.L. headquarters there are recorded the addresses of the several hundred amateur radio clubs affiliated with the League, their places and times of meetings. Clubs are splendid places to get acquainted with other amateurs and to participate in interesting discussions on amateur radio. Why not drop in at your local club and "meet the gang"? Address the Communications Manager (enclosing 3¢ stamp, please) for data on affiliated clubs in your vicinity. Give your itinerary if you are planning a trip and wish to visit clubs en route.

## Brass Pounders' League

(September 16th—October 15th)

Call	Orig. Del.		Extra Del.		Total
	Orig.	Del.	Rel.	Credit	
W4PL	11	35	1844	17	1907
W3EML	106	258	994	242	1600
W9QIL	82	144	1078	114	1418
W7EBQ	23	57	1232	42	1354
W6IOX	52	101	916	99	1168
W6DH	94	319	422	293	1128
W5MNN	24	115	868	100	1107
W5FDR	150	184	622	106	1062
W3BWT	42	63	498	55	658
W9YXH	20	50	540	36	646
W2JDC*	23	19	546	18	606
W4IR	9	490	39	33	571
W1LWH	21	62	450	30	563
W3CIZ	38	123	273	120	554
W9FAM	2	2	542	8	554
W2SC	32	149	112	255	548
W9EKQ	8	24	470	0	502

### MORE-THAN-ONE-OPERATOR STATIONS

Call	Orig. Del.		Extra Del.		Total
	Orig.	Del.	Rel.	Credit	
KAIHR	466	586	107	574	1733
W5OW	189	129	1164	65	1547
KAIHR**	607	357	86	357	1409
KAIHQ	252	99	466	88	905
W1AW	32	109	321	106	568
W9BNT	83	116	304	25	528

These stations "make" the B.P.L. with total of 500 or over. One hundred deliveries + Ex. Del. Credits also rate B.P.L. standing. The following one-operator stations make the B.P.L. on deliveries. Deliveries count.

W3QP, 302	W6MTS, 128	W2KL, 108
W4ABS, 220	W8MJK, 121	W2LZR, 108
W6NLL, 159	W9ESA, 121	W3HRS, 100
W6BIP, 142	W1JJY, 114	W6EJA, 100
W5CEZ, 139	W3GKO, 114	W9UN, 100
	W1KCT, 108	

### A.A.R.S.

#### MORE-THAN-ONE-OPERATOR STATION

Call	Orig. Del.		Extra Del.		Total
	Orig.	Del.	Rel.	Credit	
WLM (W3CXL)	133	114	2616	35	2898

A total of 500 or more or 100 deliveries Ex. D. Cr. will put you in line for a place in the B.P.L.

\* Aug.—Sept.

\*\* Corrected total, June—July.

## BRIEFS

### Contest Score Corrections

Club certificate winner for the Milwaukee Radio Amateurs' Club in the '39 DX Contest was W9VDY, rather than W9GIL as reported in October *QST*. W3FLH (E. Pa.) was erroneously listed as W3FZH; W2BDQ (N. N. J.) was listed as W2DBQ, and W2ITN (N. Y. C.-L. I.) was listed as W2LJN.

W2KHA's score of 3,851,354 (143 QSOs, 37 sections, 130 different stations) in the July '39 O.R.S. Party was omitted from the list of high scorers in October *QST*.

In the results of the VE/W Contest, November *QST*, W3GYQ (Md.—Del.-D. C.) was listed as W3GYP; VE3AKG was listed as VE3AQC.

### Checkers by Radio

Considerable interest is shown in playing checkers by radio. All that is necessary is to letter your board to identify the moves. Each player in any given game must, of course, have his board lettered the same as the other contestant. Among those interested in lining up radio checker games are W6PGL, W1JUS, W6IPG, W8PQE and W9FB.

Definition of a ham: An individual sitting in front of a new \$200 radio receiver patching a pair of three-year-old overshoes. (W1KTB recently found himself doing this very thing!)

W1AW scheduled W9ZBG, Chicago, from September 25th through October 23rd, three times weekly, on 1.75-Mc. c.w. Out of 11 schedules, only twice were ZBG's signals inaudible. On all other schedules his signals averaged S6, always perfectly readable. W9ZBG was using an input of 90 watts.

KAIHQ, Fort William McKinley, P. I., one of the Philippines' most active traffic stations, uses a 211 final with 180 watts input. Transmitting antenna is a diamond, 360 feet on each leg and 60 feet high, directed at San Francisco. This antenna makes possible KAIHQ's consistent work on moderate power.

### Three—"Fair" Hook-up

On September 11th, opening day of the Mid-South Fair, Memphis, Tenn., amateur radio exhibit stations at the three existing fairs in the United States made contact on a pre-arranged schedule—Golden Gate Exposition, W6USA; New York World's Fair, W2USA; Mid-South Fair, W4USA. The Governor of Tennessee transmitted his greeting over W4USA. Oscar Oehmen, W2KU, operator at W2USA, relayed message of greeting from Grover Whalen.

On September 22nd, the W2USA Radio Club presented the first of a series of broadcasts over W2XJI, 25.3 Mc. The program originated at Mutual's studios in the Crosley Building at the New York Fair and consisted of informal interviews of local and visiting radio amateurs and S.W.L.'s. It was presented by Arthur Lynch, W2DKJ, Managing Director of the club, and Kay I. Kibling, W2HXQ, Secretary. Guests on the first program were Fred Seid, W2MQ, radio operator on the Ellsworth Antarctic Expedition, 1938-39, and Bob Gunderson, Instructor of Radio at the Institute for the Blind, New York City.

W1BMB, Rockland, Mass., operating 3932-cc. 'phone, is interested in hearing from other amateurs who are in a position to contact revolver or rifle clubs to arrange "radio matches." Interested operators should write direct to W1BMB.

W8FU suggests that in keeping a log it makes it easy to pick out DX or local contacts if you use red or other colored ink for the DX entries and black ink for the local entries. Another use for this idea is to use the colored ink on one day and black ink the next day, alternating, thereby making it easy to distinguish between work on different days.

On August 30, 1939, Mrs. Chauvin of Beaumont, Texas, was critically injured. It was necessary to contact her sister, Mrs. J. I. Wilkins, who was traveling somewhere between San Francisco, Denver and Salt Lake City. W5FDI of Beaumont was requested to assist in contacting the auto travelers. W6DSX and W6BUW of Salt Lake were advised and informed the State Police. W9FUH of Denver obtained radio, newspaper and police aid. Mrs. Wilkins and party were found in Denver and given the message. Hams serve again!

On a visit to the World's Fair, W1HAX stopped in to operate W2USA. As he signed the log book he noticed the call W1DDG among the visitors and discovered that DDG was also present at that time. After introductions were made, W1HAX explained that W1DDG was his first QSO after receiving his ticket, six years before!

### Volunteers Needed for Railroad Nets

Chicago, Milwaukee, St. Paul and Pacific R. R.

C. A. Conklin, W9EFI, Madrid, Iowa, is heading the organization of an amateur radio emergency net for the Chi-

ago, Milwaukee, St. Paul & Pacific R. R. This is being done in a spirit of public service so that amateurs may best serve in time of disaster. Stations are needed in every town served by the Chicago, Milwaukee, St. Paul & Pacific system. Operators willing to cooperate should get in touch with W9EFI for complete information.

#### Boston & Maine R. R.

An emergency net for the Boston & Maine R. R. is being organized by Ralph H. Wickens, W1ZZC, and John E. Gibson, W1CTS. It is desired to cover the following localities: Newburyport, Mass.; Portsmouth, N. H.; Portland, Me.; Dover, N. H.; Concord, N. H.; Greenfield, Mass.; Fitchburg, Mass.; Rochester, N. H.; White River Jct., Vt.; Bellows Falls, Vt.; Springfield, Mass.; and points between these cities. It is planned to have one main frequency, probably in the 3.5-Mc. band. Amateurs wishing to serve in this net should communicate with W1ZZC, 31 Estes St., Lynn, Mass.; or W1CTS, John E. Gibson, c/o Boston & Maine R. R., North Station, Boston, Mass.

W2GVX has appointed himself a "committee of one" to help improve general amateur operating practices. Whenever he hears an operator doing anything he believes is not according to recommended practice, he calls him and tells him so. If he cannot raise the offender he drops him a post card explaining the situation. Off-frequency operation, long CQ's, long calls right on the frequency of the station called, trying to break up a DX QSO for one's own gain, bad notes, over-modulation, are all among the subjects of his crusade. Believing that the average operator will not know of his wrong-doings unless told, W2GVX urges other amateurs to be frank with brother hams in pointing out their faults.

The first annual hamfest and basket picnic of the Mon-Yough Amateur Transmitters' Association (McKeesport, Pa.) held at Renziehausen Park, Sunday, August 27, 1939, was well attended and all reported a good time. The afternoon was spent in playing mushball and Indian ball. W8IZG and his team defeated W8QVF's team at mushball, 11 to 7. Supper was furnished by the ladies.

W5GZK of Ada, Okla., and W5GKZ, Fort Smith, Ark., made contact on 28 Mc. on August 23, 1939, completing W.A.S. for each operator!

W2TY of Hollis, L. I., claims he is the first ham to have a hill moved to improve 56-Mc. transmission, the conventional method being to raise the skywire. Two blocks northwest of his shack, a ridge rising 30 feet above the radiator has been a thorn in the side of ultra-high frequency work for three years. This summer a speculative building company bought the ridge, flattened it out with steam shovels to permit the sale of nice, flat lots!

Calling CQ one night on 7120 kc., W2SC was answered on the same frequency by W6SC, San Francisco. The operator of W2SC hails originally from S. F., making the coincidence complete!

The Fort Smith (Ark.) Amateur Radio Club, at the request of the Fort Smith Police Department, took part in the Bob Burns Home-Coming Celebration. Members of the club set up portable rigs in strategic parts of the city for two-way communication with police headquarters. They were to be used to provide information to visitors as well as help the police force report in on official business. The amateurs participating were W5GAS, W5HYS, W5BRW, W5CFQ, W5HNU, W5ICS, W5GWT, W5GTS and W5HPL. The rigs were operated on both 1.75 and 28 Mcs. and were in constant communication with police headquarters for most of the day and until about 9:00 p.m., on the date of August 7, 1939. Plenty of practice was provided in setting up portable equipment, and amateur radio reached new heights in the city of Fort Smith.

## Cruise of the "California"

THE world cruise of the Yacht *California* is to take one and one-half years and carries the party of nine from San Francisco to the Marquesas Island, first of the South Sea Group (Windward Island), through all the South Sea Group to Bali and Java, Borneo, Straits Settlement, and Penang and Ceylon to Madagascar, South Africa, Cape Town and various other island groups to England, from England to the Azores, Windward Island, Panama to San Francisco. The ship sailed early in September.

Harold T. Mapes (W7DXV), the radio operator, is an old timer in the radio game, having operated BX in Mexico for eight years, and is well known throughout amateur circles. He has been an amateur since 1916. During the World War, he operated on the tanker *Silver Shell*. The *California's* call is WLFW, and they are licensed to operate on 6226 kc., having authority from the F.C.C. to handle traffic with amateurs. A daily schedule is held with W6BIP at 7:00 a.m. PST daily. After completing traffic work with BIP, WLFW will call CQ for replies from amateurs. The radio apparatus consists of two receivers, a reconstructed SW3 and a Skyrider Defiant. The transmitter consists of a 6L6 oscillator and 6L6 amplifier with 25 watts input. In addition to the regular power source, there is an auxiliary power supply consisting of a motor-generating outfit, which will keep the storage battery charged and furnish a 32-wolt lighting system.

— Wm. A. Ladley, W8RBQ



#### MINNEAPOLIS CENTENNIAL CELEBRATION

The City of Minneapolis celebrated its 100th birthday the week of October 2-7, 1939. The Minneapolis Radio Club upheld the part of amateur radio. Geo. Collier, W9CWI, club president, appointed Geo. Smith, W9ZXX, chairman of a committee to produce a suitable exhibit. Following the trend of the celebration, the display depicted the progress of radio. It's surprising how much radio equipment of another day there is around the shacks of the "old timers." Nothing was left to the imagination in the exhibit, unless it was some of the spirit of the spark days which could only be brought out with the crash of a spark or the climbing song of a rotary gap coming up to speed!

Much interest was shown in this display of the forerunner of modern day radio. And as for modern day radio, there were the latest in receivers and transmitters, as well as a complete emergency set-up including a gasoline-powered generator. W9ZXV's newly completed rack and panel transmitter, with T40's in the final, was operated from the booth in the Minneapolis Auditorium during the entire week. A 90-foot vertical Zepp was suspended from the ceiling of the mammoth building. The various noise limiters in the receivers did their stuff with the many forms of noise-makers in surrounding exhibits. When broadcast receivers were brought into other booths to listen to the World Series and football games couldn't huck the noise, the amateur booth "carried the mail."

Those who served at the amateur exhibit believe much good was accomplished in bettering public relations. Active in assisting W9ZXX to make the exhibit a success were W9SJK, W9LEB, W9TAT, W9RTE, W9YPT, W9BP, W9ZXV, W9OTE, W9ITQ and W9CCX.

— A. A. Emerson, W9ITQ

# How's DX?

**HOW:**

**W**ELL, you fellows certainly are optimistic, turning to this page this month. Pickings have been mighty slim — every time we start listening for DX these days we're reminded of that Robert Service poem that starts out "Were you ever out in the great alone?"

But we'll have to hand it to the DX boys — they're really persistent. Just let a hunk of DX raise his peep out of the background and the lads are all over him — and he comes back to somebody else. A few mornings of that and some of the weaker gentry get discouraged, in a way. Not all of them give up, though, but simply turn to other methods, like the one WIBGY told us about the other day. BGY is QSL Manager for the First District, you know, and a fair hand at DX himself. It seems that some brilliant W1, discouraged a trifle by being unable to raise the stuff but awfully anxious to make the DXCC, wrote BGY a letter saying he had a lot of transformers, condensers and tubes kicking around and that Jules was welcome to them. In return the fellow only wanted a few DX cards, and named the prefixes! No kidding — we can show you the letter — and he coolly admitted that typewritten ones were preferable because, we suppose, they're easier to alter. The ignorance of the guy! The poor, misguided dope! Doesn't he know that QSL Managers only accept cash?

We hope none of the QSL Managers will take us seriously — we've had dealings with most of them and we know they're a swell bunch, in spite of the fact that their normally-thankless job would be enough to turn anyone after a while. It only takes a letter of thanks to your QSL Manager when you send in an extra envelope to make the thing worth while for him, but too many fellows seem to think the guy's a hired servant and treat him as no well-bred person would treat even a servant.

Of course, QSL Managers have their weaknesses, too, but that kind of manager doesn't last long. There was the Central-American fellow a few years back who was handling the cards for his country and when he applied for WAC, three of the six cards were ones originally intended for someone else. And a North-American QSL Manager was recently dropped from the DXCC because some of the cards he submitted were never meant for him. We'd tell you his call but we hate tar-and-feather parties — they're so messy.

**WHERE:**

**A**LTHOUGH transmission conditions seem to be fairly good, the stations just aren't on the air. It would appear that almost all of the Europeans are off the air, with the

exception of the Russians and one or two German stations. an odd EA, an occasional I and once in a while a few from some of the smaller countries. As you know, the very-active ZS have been closed down and, with the belligerent colonies off in Africa, not much comes from there. Most of the gang seems to be concentrating on the stuff over around China and KA and a lot of new ones have appeared out that way . . . . We have received word that the F QSL Bureau is inactive at present, although the G Bureau still functions . . . . We should like to answer some of the questions about the EA's, but we haven't any dope we can trust . . . . In South America, the LU's have been restricted to four hours' operating out of the twenty-four, but they have their choice of any four hours. They have to work on fixed frequencies, and are no longer allowed to jump around . . . . The order making the HK's speak only Spanish has apparently been rescinded, having lasted only about two weeks . . . . We jumped the gun last month when we got all happy about AC4JS. WIAB says that XU8MI told him that AC4JS wasn't in Tibet but in XU4 . . . . Jerry Petranek, whom we mentioned was going to be on in U. S. Samoa, is out there, but can't convince the governor that a ham station won't do any harm. Jerry wasn't using KH6KKR, as some of the gang thought . . . . Our spy ring isn't functioning as well as it used to, else we'd be able to give you some dope on AR3AF (14,370-400 T9), worked by W2BHW, W1ICA, W1IOZ, W4FIN and others. The guy gives his address as Box 107, Beyrouth, Syria, and shows up in the right direction, but we'll believe it when we see a card. "Remember the AR3MO," we always say . . . . The smart lads are keeping one ear open on 40, as you know if you've listened there lately and found how many of the gang are up there. W2BHW got it via the grapevine that that's where LB6U, Jan Mayen, hangs out, which is inducement for 'most anyone . . . . W9NTA gives the address of CR7BN (14,330 T9) as Cremildo Pereira, P. O. Box 943, Lourenco Marques, Mozambique . . . . W1CBZ scared up EK1AA (14,375-14,350 T9 with drift) during the late afternoon and adds that you have to kinda dig for the 9-watt signal . . . . QSL U0AD (14,395 T8) via W9RBI . . . . We wouldn't know about Y16ZC (14,390 T9C) except that he says to QSL via the R.S.G.B. and spells it "Bahgdad," which is something . . . . QSL VO5BA via W3LN . . . . W6QL gives the address of XU6UK (14,390) as Box 164, Kukong, Kwangtung Province . . . . W1ADM can't get straight on the CR6's. He worked CR6AI a while back and was told to QSL via R.E.P. Then CR6AF said to QSL via 6AI, and later he heard 6AK tell someone to QSL via 6AF. If they ride around enough times, someone may get the brass ring and a free ride.



Most of these fellows are well-known to you because of their roaring signals that have pounded through year after year from South America. From left to right, rear row: LU2AX, LU2DD, LU8AD, LU4BH, LU3DH, M. Suarez, ex-LU1ZA. Center row: LU1EP, LU7AZ, LU2CW, LU9AX, LU1CA. Front: LU6DG, LU6AX.

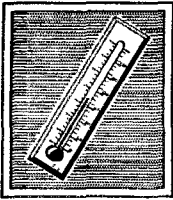

LIKE automobiles, communication receivers have reached a stage of development where progress is measured by details that were considered of secondary importance ten years ago. Although designed back in 1931, the little 3-tube SW-3 regenerative receiver is a very capable performer so far as sensitivity is concerned, and it is still widely used where there is not too much interference. But modern conditions

being what they are, sensitivity is not enough. It does not do much good to pull in a signal if interference makes it unreadable, and razor-sharp selectivity is worse than useless if the receiver (and transmitter) is not stable enough to stay put. Problems like these are so basic in modern receiver design that we would like to keep you posted on what we are doing about them.

For a start, let us take a look at the problem of temperature drift. It is a tough one, and no one has it completely solved as yet, although a lot of progress has been made. Nearly everything in the receiver is affected by a change of temperature (even the wiring), and furthermore different parts of the chassis do not heat up and cool off at the same time. When the set is first turned on, the tubes heat first, together with the power transformer, if there is one. The heat from these sources gradually warms up other parts. It may take several hours for the coils to reach maximum temperature inside their shields. With different parts of the set at different temperatures, there is no simple device that can be used to compensate for all of them.

One of the best attacks on this problem that we know of is the work that Stuart Briggs (W1KHE) has been doing with his NC-101X. He mounts a 10 mmf. compensating condenser close to, and slightly above, the high frequency oscillator tube. In this position it is affected rapidly by the temperature of the tube, and more slowly by the other parts of the receiver. He has obtained excellent results on 20 meters. We should expect results to be equally good on 40 meters, possibly good on 10 meters, and doubtful on 80 meters. The 160 meter band seems to be out, because the 10 mmf. is more capacity than the circuit permits.

Aside from the fact that it does not give perfect compensation during the warm-up period, the main defect of this system is that it can compensate for only one value of tuning capacity. On a receiver like the NC-101X, where the whole range of the tuning condenser is used to cover each amateur band, the frequency range on any one band is small enough to make the system work very well. But unless this sort of electrical bandspread is used, the scheme is not practical.

Of course, the best way would be to compensate each part individually. Good air dielectric condensers can be designed to have very low drift. Coils are more of a problem, but with care temperature changes can be minimized. There is still a lot of room for improvement, but our receivers are remarkably stable once they have warmed up. One of the air lines remotely operates its HRO's without a tuning control at the operating position. They are left running all the time, and they stay tuned right on the nose. As we remarked once before on this page, it is excellent operating procedure to leave filaments turned on all the time. Tubes last longer that way, and the receiver is always ready to go.

This is not the final answer, of course. One of these days we hope to be able to tell you that the problem has been licked.

CALVIN HADLOCK



# For Amateur Radio Hardware See MALLORY-YAXLEY

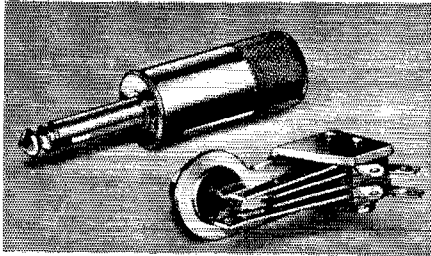

Two-way phone plug No. 75N, with shielded nickel shell. Other types—three-way, tie cord, etc.—in both bakelite and nickel shells.

Junior Jack No. 704—springs are parallel to panel for compactness—thirteen combinations available in this type.

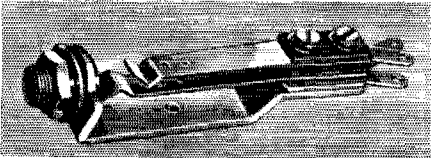

This three circuit microphone jack No. 2B is typical of the famous Mallory-Yaxley Line. A variety of spring combinations is available for practically any application and special models can be furnished on order.

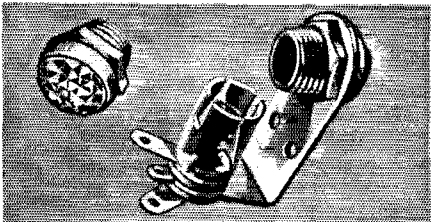

Avoid run down batteries, or increased power bills by using Mallory-Yaxley Pilot Lights and Jewels as indicators. They will keep you "informed" at all times, and enhance the appearance of your rig.

**P. R. MALLORY & CO., Inc.**  
INDIANAPOLIS INDIANA  
Cable Address—PELMALLO

Use

P. R. MALLORY & CO. Inc.

**MALLORY**  
APPROVED RADIO  
PRECISION PRODUCTS

Use

**YAXLEY**  
APPROVED RADIO  
PRECISION PRODUCTS

## WHEN:

The 10-meter band is perking along right well, with lots of Central and South American 'phones on. The Africans were bouncing through until they had to quit. Even a few c.w. fellows get on during weekends and, if they're not careful, they may start working some DX there again. But all honors go to the 'phone men these days.

As mentioned earlier, the smart lads keep an ear on 7 Mc. W2BHW tells us that Z54P, in Basutoland, was on 40 for a while, and W6PCP scared up J8CL, PK1FO, and KA3RA, and heard some MX, MZ, and some of the South Sea islanders, but these latter are weak and hard to raise because of the QRN they have to work through. You'll find a lot of the old 14,400-ke. W's up on 40 during the evenings, swapping lies, and telephone numbers.

It's a little difficult to know how much of the dope we should use, because the picture may be changed still further by the time the magazine is out. It doesn't help much, for example, to list the flock of new Z's that were reported because they aren't available . . . . Asians seem to be the order of the day, and W2HHF has his share: XUGAL (14,300 T8), XUEHM (14,400), XU2MC (14,350 T8), MX3H (14,320 T8), J8CH (14,400 T8), J2KN (14,400 T9), XU6TL (14,360), J8CL (14,370 T8), XU8WS (14,400, -350, -380), XU8MA (14,370 T8), XU5YT (14,255 T8), XU6K (14,220 T8) and XU5WT (14,340 T8) . . . . W2BHW doesn't lag anyone, with PK5AB (14,330 T8), J8PG (14,315 T6), PK1HX (14,260 T9), MX1A (14,400 T8), MX3I (14,400 T7), XU5LT (14,370 T8), XU7A (14,400 T8), XU4CV (14,400 T7), XU60 (14,370 T7), PK1VK (14,180 T9), XU5HC (14,300 T7) and CR6AK (14,350 T7c), mostly in the morning between 8 and 12, with a few coming through around 5:30 P.M. . . . . Some of the Russians reported through various sources include UX1CP (14,400 T8), U4AL (14,375), UK9AN (14,400 T7), U9BC (14,400 T9), UK3AH (14,400 T7), U9ML (14,400 T9x), UB1B (14,380), U0AX (14,365 T6), U0AC (14,400 T8), U3BM (14,400 T9) and U3BG (14,400 T9) . . . . W2AV reports KF6OWR (14,380 T9), while W1CBZ adds KB6RWZ (14,385), KB6RSJ (14,390), CR6AI (14,300), CR6AF (14,380), J8CA (14,395), XUBMI (14,350), KALFC (14,320), J2KQ (14,300), LZ1ID (14,300), PK1XZ (14,250), PK1BX (14,350), PK3ST (14,300) and PK1TM (14,340) . . . . W4BYF gives us KAIHR (14,320 T9), WIADM CEC3B (14,400) and OQ5IM (14,360), and W7HAD HAZ1 (14,290 T8), KAILZ (14,270 T9), HCIAR (14,325 T6) and LU3DD (14,400 T9) . . . . W1IOZ has been busy with J3FP (14,375), CE3BF (14,400), HK4DD (14,300), PK1TT (14,345) and KAIWW (14,340).

## \*PHONE:

The 28-Mc. band is doing all right for itself, with conditions so good you have to have a walloping signal before they'll answer you. W5FTA reports ES5X (28,430), K6OQM (28,975), LU4HG (28,090), LUIDJ (28,160), CE3AG (28,350), T99AA (28,335), YNSDG (28,160), CE3CZ (28,250), XE1GE (28,450), TI2RC (28,450), TI3AV (28,345), K6MNV (28,900), LU2BC (28,200), YV1AQ (28,190) and XE1CQ (28,350).

On 20, W3BET has a nice list which includes KA1BB (14,250), KAILZ (14,250), KA1CS (14,150), KA7EF (14,150, -250), CX2BK (14,100), IIMZ (14,135), HA1K (14,145), LU2BG (14,120), PY7AI (14,090), LU1QA (14,095), KA1FH (14,150) and KA1CW (14,150) . . . . W9RBI gives XU8AM (14,080) and EA7BE (14,140), while WIADM is in with K7HCK (14,210), PK1OG (14,040), XU8ZA (14,040), XU6KL (14,030), CR6AF (14,210) and PY7AE (14,270) . . . . W6IKQ added to his list with OZ5BW (14,080) and KB6ILT (14,245), while a new rhombic at W6ITH accounts for HK3CY (14,140), LU8AG (14,100), LU4CJ (14,145), CE1AC (14,140), LU2DG (14,090) and others down that way. EK1AF (14,065) seems to be the best coming through from Africa, although OQ5AB (28,215) is on occasionally.

## WHO:

KB6RWZ needs N. H., Maine and R. I. for WAS . . . . W9UXI made his 'phone WAC with 35 watts input and a 3-element rotatable . . . . G2ZQ, G6WY, G5ZJ and G6FO are all officers in the R.A.F. . . . . W1RR forwards a letter from a G telling about the close-down over there. G.P.O. engineers drive up to the amateur's door with a van and a warrant, remove power packs, crystals, coils, tubes, freqmeters and keys, and then make a



# BIG *for its size*

Size considered, this little tube has tremendous power capabilities. In class "B" audio, a pair of these tubes are capable of a power output of some 250 watts with only 1500 volts on the plates. A single 35T with 2000 volts on the plate will produce a strong 250 watt carrier in class "C" telegraphy. Extremely low interelectrode capacities and a high order of electrical efficiency make it ideal for use as crystal oscillator or frequency multiplier.

The long life and sensational performance records established by Eimac 35T tubes has yet to be equalled.

35T

## BIG *for its price* \$6

*All Eimac tubes are unconditionally guaranteed against tube failures which result from gas released internally.*

### NEW . . . Eimac 35TG

Designed especially for use on ultra high frequencies . . . grid lead taken directly through the bulb. Ratings exactly the same as Eimac 35T except for the following:

Grid to plate capacity 1.7 mmfds

Grid to filament capacity . . . . 1.9 mmfds

LIST PRICE \$6.75

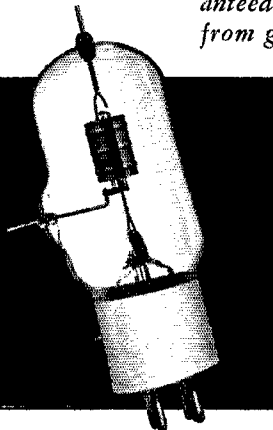

# *Eimac* TUBES

EITEL-McCULLOUGH, INC.

770 San Mateo Ave., San Bruno, California

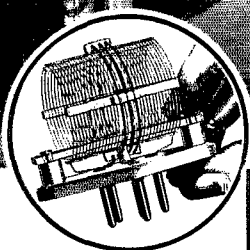
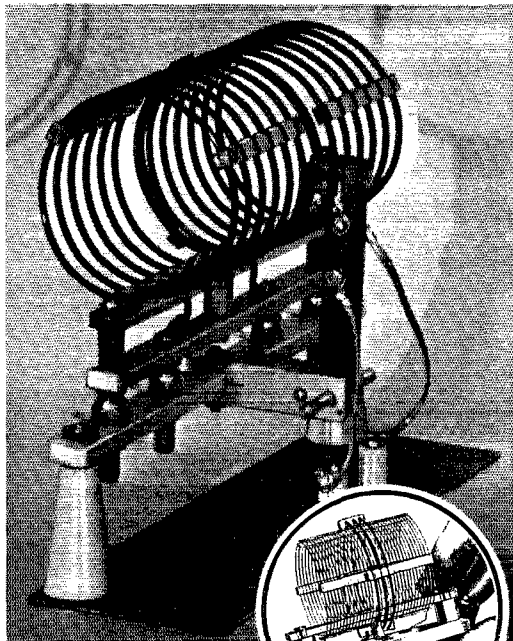

From the  
**LARGEST** TO THE SMALLEST  
 . . . Every AIR INDUCTOR is  
 Champion of Its Class!

All down the line -- from the rugged, heavy-duty 1 K.W. HDVL Assembly to the extra-small 25 Watt "Babies" -- B&W has pioneered and perfected new methods of construction, new ideas in design and new refinements in coil winding technique which make AIR INDUCTORS absolutely "tops" in all-round dollar-for-dollar value.

The types illustrated here are but a few of the newer B&W developments -- the complete B&W line includes three sizes of Variable Link Assemblies, sixteen Variable Link Coil types, six Band Switching Turrets, ten Antenna Coils and more than forty types of Standard and Fixed Link Coils, including the famous B&W "Babies." Here is the efficient, economical answer to every amateur coil problem!

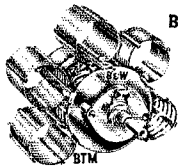

**BAND SWITCHING SIMPLIFIED!**

These 35-Watt Baby Turrets, another B&W "first", provide efficient front-of-panel coverage of the 10- to 160-meter bands, yet require a minimum of space. Four types deliver highly efficient band-switching in all low-power transmitter and exciter stage applications. \$8.50 each, Net.

**CRAMPED FOR SPACE?**

The "BAND-HOPPER" (Type 2A Band Switch) is the answer to the crowded rig question! Covers all five bands, 10 to 160, from front of panel, yet squeezes in a space only 2 1/4" x 3" x 2". A real investment in accuracy, speed and convenience! Net \$3.25.



See AIR INDUCTORS at your jobber's—  
 or write for details

**BARKER & WILLIAMSON**

Radio Manufacturing Engineers • ARDMORE, PENNSYLVANIA

Export Address: ROYAL NATIONAL CO., 89 Broad St., New York, N. Y.

thorough search for anything that may be concealed, after checking to make sure the antenna is down. The gear is, of course, stored in the government warehouses and will be returned if and when . . . GM3TR writes to say that he had to change his address in a hurry, and had to leave his log and cards behind, with the result that some W's may not receive the cards they had coming from him for some time, until he can get back his log . . . J2MI is supposed to be in Mongolia and, since he was heard on 14,055 a few weeks back, might be worth going after . . . W2AZ has moved out to Ohio, after being the first to make the CC on 'phone . . . We have a QSO list from PZ1AB, in case you worked him and would like DXCC credit. He's off the air now, temporarily, we hope . . . PK1TT is working hard for WAS, but still needs 19 states . . . W5ADZ is keeping his chin in these days. He was one of the first to work VJ2AA, who said he was on San Ambrosio Island. ADZ expressed a certain amount of doubt in no uncertain terms and signed with the guy. He'd forgotten about the whole thing when his mailbox started filling with cards and letters from the gang addressed to VJ2AA care of W5ADZ! VJ2AA was telling all his contacts to QSL care of W5ADZ, and now Brad wonders if that's the BL's method of paying him back for being a skeptic!

— W1JPE

**Ham Loses License for Obscenity**

The license of Deron Terzian, W6ONO, Modesto, Calif., has been revoked, following the charge that Terzian transmitted obscene, indecent and profane language while engaged in the operation of his amateur radio station.

Station KPAB, Laredo, Texas, 1500 kc., broadcasts a daily "Mexico Tourist Program." Time is midnight to 6:00 A.M. CST, except from the 8th through the 14th of the month, when the program runs from midnight to 2:00 A.M. Reports are requested from radio amateurs. For every report of reception, souvenirs of Old Mexico will be sent.

L. M. Sparks, W4DRE, suggests that a "Guest Register" would make a useful addition to the average amateur station. Many hams have visitors sign the station log, but a register in which all guests could sign their names, whether or not they operated the rig, would make an interesting record. Any of the available books designed as guest registers would serve nicely, but an ordinary bound notebook could be ruled "as you like it." The principal items would be (1) date, (2) name, and call, if any, and (3) address. The "guest register" in use at W1AW is rapidly getting filled up!

W6LIF points out that it is the practice in the airlines to refer to cities by their teletype designation, the same being used as an identification for the C.A.A. beacon at the respective cities. For example, Oakland is always OA, Chicago CG, Cheyenne CX, etc. W6LIF suggests that amateurs might make use of these letter-designations in referring to names of cities. It is believed that the C.A.A. Radio Facility List, which contains approximately 140 cities and designations for same, could be procured at local flying fields. Hams interested in the idea of putting the scheme to work in their operating should get one of those convenient lists.

**DARN THESE LIARS!**

The familiar story (to Official Observers), "The station I was working gave me T9 . . . said it sounded swell. W4 --- had the same experience but got no 'friendly notice.' The rig is crystal or e.c.o. and it was the e.c.o. I was using at the time my sig. was T4. I certainly want to thank you . . ."

W4FNR suggests to Observer W1IBF that QST urge ham operators to grasp the point that *truthful reports are appreciated, that untruthful reports can lead to hard feelings against the fellows who give them, be the reports ever so flattering.* FNR says, "Don't lie! Give the fellow what his report really is. If he indicates his feelings are hurt, he isn't much of a ham." At any rate one can put the unappreciative fellow down, as a ham who doesn't care how much of the band his signal takes, and isn't considerate of the other fellow, so perhaps his own feelings don't have to be given too much consideration by the reporter. At any rate Observers report that *real hams* always do appreciate a chance to avoid F.C.C. citations, and to make their signal one in which the fraternity can take pride. W4FNR writes, "DARN THESE LIARS!" The moral to all? *Give truthful reports.*

*Your eyes can't  
tell them apart*

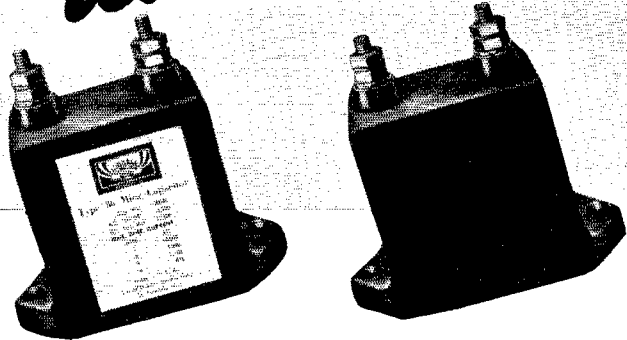

*but*

. . . your meters can! Typical of the extra quality Cornell-Dubilier builds into capacitors are these features of the C-D Type 86 Mica Transmitting Capacitor—Patented series mica stack—eliminates corona losses. Horizontal stack construction—wide separation of leads, maximum insulation. India ruby mica dielectric—low power-factor, high Q. Vacuum impregnated assembly—low loss, high insulation, no air voids. Special low loss filter—reduces stray losses. Short heavy brass stud terminals—low resistance connection. Insulated clamp holder—no internal voltage arc-over. Black glazed porcelain dehydrated case—low r.f. losses.

Next time you order capacitors, be particular. Ask for, insist on and get C-Ds. They cost no more. *Catalog No. 175A free on request. Product of the world's largest manufacturer of capacitors.*

**MICA • DYKANOL • PAPER • WET AND DRY ELECTROLYTICS**

*demand*

**CORNELL-DUBILIER**

*a great name in capacitors*



**CORNELL-DUBILIER  
ELECTRIC CORPORATION**

1013 Hamilton Boulevard, South Plainfield, New Jersey

Cable Address: "CORDU"

# "Split-Hairs"

To CARDWELL, "splitting hairs" over the extent of accuracy in mechanical and electrical characteristics is like taking castor oil . . . unpleasant but absolutely necessary.

Recognized as a standard of comparison, CARDWELL components must never fail to justify their acceptance and selection by designers of fine commercial and amateur equipment.

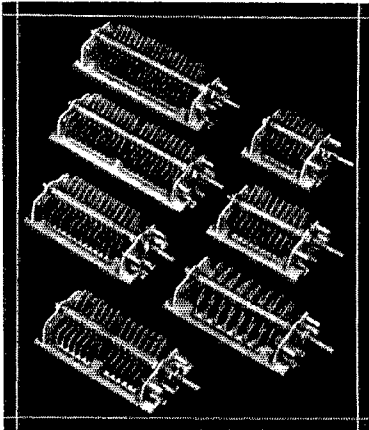

## Specifications of "N" TYPE U.H.F. SERIES

**FRAME** — No frame or tie rods. Aluminum end plates supported directly on heavy lateral ceramic bars which carry stators.

**SHAFT** — 1/4" cadmium plated steel on which rotor assembly is securely locked.

**PLATES** — Aluminum alloy .040" thick with edges rounded.

**BEARINGS** — Long, nickel-plated brass, shoulder type front bearing, with ball thrust rear bearing. Laminated phosphor bronze rotor contactor.

**AIRGAP** — .070" — 3000 V. peak — (NT)  
 .084" — 4200 V. peak — (NP)  
 .171" — 6000 V. peak — (NG)

**MOUNTING** — Single hole, front panel with mounting posts or chassis mounting on feet which form part of end plate. Or use type "M" bracket and mount upside down for lowest capacity to ground.

## ★ ULTRA-HIGH FREQUENCY SINGLES

Type	Max. Cap.	Min. Cap.	Nr. Plates	Air-gap	*Dim. "A"	Net Price
NP-50-DS	50	9	13	.084"	2 1/4"	\$2.10
NP-75-DS	75	11.0	19	.084"	3 1/16"	2.46
NP-100-DS	100	13	25	.084"	4 1/8"	3.82
NP-150-DS	150	19	39	.084"	5 5/8"	3.66
NP-35-DS	35	11	15	.171"	4 1/8"	3.12

## ★ ULTRA-HIGH FREQUENCY DUALS

Type	Per Section			Air-gap	*Dim. "A"	Net Price
	Max. Cap.	Min. Cap.	Nr. Plates			
NT-50-GD†	50	7	11	.070"	3 1/16"	\$3.60
NP-35-ND†	35	5	9	.084"	3 1/16"	3.60
NP-50-DD	50	9	13	.084"	4 1/8"	3.21
NP-75-DD	75	11	19	.084"	5 5/8"	3.60

\*Dimension "A" is distance between inside faces of end plates. For overall length back of panel, add 1 3/32" to "A" dimension.

†.040" plates, buffed and polished.  
 †.025" plates, buffed and polished.

## MEMBERS, DX CENTURY CLUB

W6GRL..... 147	W8NJP..... 115	W6TJ..... 104
W8CRA..... 144	W1HX..... 115	W3BEN..... 104
G6WY..... 144	G5BD..... 115	W1CGX..... 104
W2GT..... 144	W9KA..... 114	W9CWW..... 104
W2GTZ..... 142	G5RV..... 114	W2BMM..... 104
W1TW..... 141	W8BKP..... 114	W9RBI..... 104
W6KIP..... 140	W2DC..... 114	G6KP..... 103
W8DFH..... 139	G5BY..... 114	W8KKG..... 103
W9TJ..... 139	G2DH..... 113	J2JJ..... 103
W1SZ..... 137	W8MTY..... 113	W5CUJ..... 103
ON4AU..... 137	G6CL..... 112	W3KT..... 103
W2ZV..... 136	W6GAL..... 112	W8DOD..... 103
W2GW..... 135	W3EVT..... 112	W9NNZ..... 103
W3EMM..... 135	W4CYU..... 112	W4IO..... 103
W6CXW..... 134	W3GAU..... 112	W4CBY..... 102
W1LZ..... 133	W1ADM..... 112	W8AU..... 102
W1TS..... 132	W8QXT..... 112	W8OXO..... 102
W8BTI..... 132	W2AAL..... 111	W1FTR..... 102
W4BPD..... 132	W3BES..... 111	W2BXA..... 102
G6RH..... 131	ON4UU..... 110	W1GDY..... 102
W2BHW..... 131	PA0XF..... 110	W1GNE..... 102
W5VV..... 130	W2CJM..... 110	W4BVD..... 102
HB9J..... 129	W6FZL..... 110	W2AY..... 102
W8DHC..... 129	W2DSB..... 110	W3ZX..... 102
W5BB..... 129	W9UM..... 110	W3GEH..... 102
W3EPV..... 128	W2AER..... 110	F8RJ..... 101
W8OSL..... 127	W8IWI..... 110	VK3XJ..... 101
W2CMY..... 127	W5QL..... 110	W4AJX..... 101
W9KG..... 126	W1WV..... 109	W6DOB..... 101
W2UK..... 126	W3DDM..... 109	SUI1WM..... 101
W8ADG..... 126	VE2AX..... 109	W8EUY..... 101
W3CHE..... 126	W6FZY..... 109	W1CC..... 101
W9ARL..... 125	W2GRG..... 109	SUI1SG..... 101
W8HFF..... 125	W6HX..... 108	G6MK..... 101
W1FH..... 125	Z5ZX..... 108	W6AHZ..... 101
W1DF..... 124	W1DUK..... 107	W4MR..... 101
W8QOF..... 124	W2CBO..... 107	W6GHU..... 101
W8DWV..... 123	G5BJ..... 107	W6BAM..... 101
W8LEC..... 123	VK2DG..... 107	W2GNQ..... 101
W4CEN..... 123	W7DL..... 107	W6KWA..... 101
D4AFF..... 123	W6MVK..... 107	W1RY..... 101
W9TB..... 122	VK3QK..... 107	W4EQK..... 101
W2JT..... 122	W1BXC..... 107	G6NF..... 100
W2ZA..... 121	W3FQP..... 107	W6KRI..... 100
W8JMP..... 120	W1IAS..... 107	W9DUQ..... 100
J5CC..... 120	G2TR..... 106	VE2EE..... 100
W2GVZ..... 120	W1GH..... 106	VK2ADE..... 100
W9GDH..... 119	W3AG..... 106	Z1LIX..... 100
W3FRY..... 119	HB9BG..... 106	HB9X..... 100
W1BUX..... 118	W1BVG..... 106	W9RCQ..... 100
W3EDP..... 118	VE3QD..... 106	W1ZT..... 100
Z1IHY..... 118	HB9CE..... 106	Z1LIM..... 100
W9ADN..... 118	W2VY..... 106	PAQOF..... 100
W1JPE..... 118	W2QA..... 105	W8BSF..... 100
W9FS..... 118	W4DRD..... 105	D3BMP..... 100
W7AMX..... 117	G5QY..... 105	W3AGV..... 100
W9PST..... 117	VK3CX..... 105	W8JTW..... 100
W3EVW..... 116	G2MI..... 105	W8GHW..... 100
W5KC..... 116	W1ICA..... 105	W8JAH..... 100
W2BYP..... 116	W2IOP..... 105	W9LBB..... 100
W1AXA..... 116	W4TO..... 105	W4CH..... 100
W6ADP..... 115	W8LYQ..... 105	W8LFE..... 100
W9EF..... 115	E1SF..... 104	W2ARB..... 100
VK5WR..... 115	W1ZB..... 104	Radiotelephone
W2CYS..... 115	F8RR..... 104	W2AZ..... 102

The following have submitted proof of contact with 75-or-more countries: W8AAJ, W9VDY, W8QDU, W9AJA 99; VK6SA, W2ALO, W6ADT 98; G6GH, W2BJ, W2JME, W8LZK 97; W1AW, W2CTO, W6ASG, W8BOX 96; F8LX, F8RAB, G6XL, W3AU, W3EMA, W8IQB 95; W3A00, W8CJN, W9BEZ 94; G6ZO, ON4GK, PA0QZ, W1IOZ, W3WC, W6FKZ, W6MEK 93; SP1LE, W3GHD, W4DME, W6TT 92; W3FLH, W3OP, W9GBJ 91; D3CSC, G6YB, LU7AZ, ON4FE, SP1AR, W1CBZ, W4TZ, W8KTW, W8PQQ, W9JDP 90; W2CUQ 89; G2DZ, W3JM, W9PG8 88; G8IG, W1KHE, W2BZB, W6GPE, W9AEH 87; W1BGC, W8DAE, W9PLH, W9VKF 86; VK2TI, W1DOV, W4CFD, W6GK, W8LAV 85; SM6WL, W1BFT, W6AM, W8WBW, W90VU 84; OZ7CC, VE2GA, VK3HG, W2AWF, W2FLG, W6DTB, W6KUT, W8BFG 83; E14J, W1EWD, W3AYS, W8OUK 82; W9GY 81; W1PBN, W2BNX, W8ATV, W3OVN, W3EPE, W4OG, W6LJD, W8AAT, W8BWC, W8DGP, W8ITK, W9DIE, W9GKS, W9GMV 80; PY2DN, W3EJ, W8JFC, W9MRV 79; W3DRD, W4EPV, W6NLZ, W8FJN 78; G3BD, LA2X, W8CED 77; PA0JMW, W3BSB, W9HUV, ZELJI 76; W4AHF, W9YNB 75.

Radiotelephone: W6OCH 98; G5RV, W2LKY, W4CYU 89; W3EMM 85; W1AKY, W2IKV, W8LFE 80; W1ADM 78.

**THE ALLEN D. CARDWELL**  
**MANUFACTURING CORPORATION**  
 83 PROSPECT STREET, BROOKLYN, NEW YORK

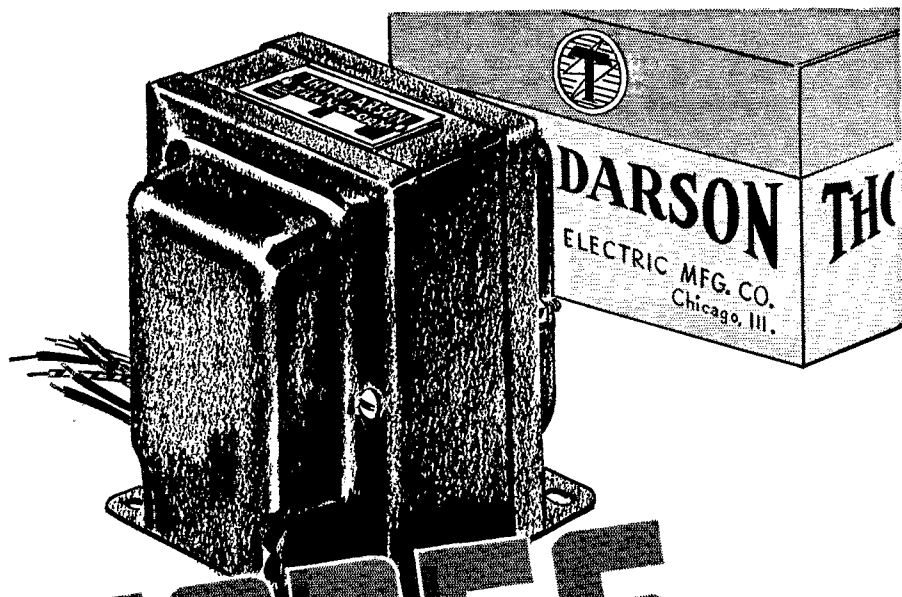

# T-19P56

That code word spells "DEPENDABILITY" in the minds of amateurs in every country on earth. Because the THORDARSON T-19P56 is the world's largest-selling Plate Supply Transformer!

Ten pounds of iron and copper, engineered by forty-four years of actual experience!

Ask your Parts Jobber for THORDARSON catalog No. 400-D.

# THORDARSON

Elec. Mfg. Co., Chicago

"THERE IS 44 YEARS OF EXPERIENCE BUILT INTO EVERY THORDARSON TRANSFORMER"

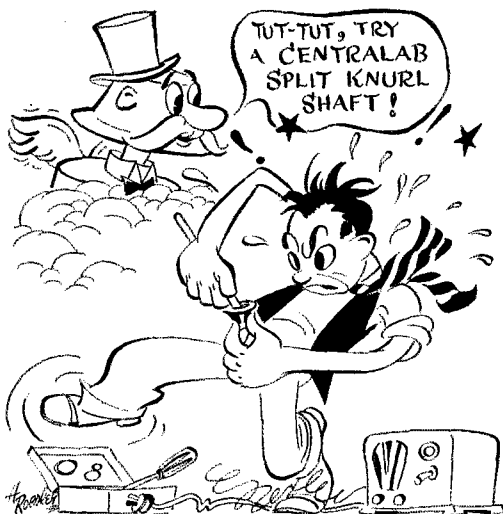

# Centralab

## UNIVERSAL SPLIT-KNURL CONTROL

Sh! It's a dank dark secret... known only to several thousand service men... it takes a special shaft to fit the knobs on many of the new (1938-39-40) sets.

So, instead of tearing your heart out thinking up new cuss words, get in touch with your nearest Centralab jobber for a Universal Split-Knurl control with the shaft that cuts as easily as butter.

Shaft is brass —  $3\frac{3}{8}$ " long from mounting surface. For switch type add Midget Radiohm switch covers K155, K156, K157, or K158.

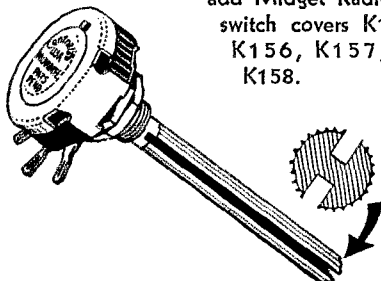

**CENTRALAB**  
Div. of Globe-Union Inc.  
Milwaukee, Wisc.

Local emergency preparedness is one thing, with established nets and methods of operation. We should also in every other possible manner show our value and worth. This is to a great extent a matter of personal ability. Now is the time to study our individual attributes — do it every few weeks — to see how we size up. High pressure mental work, such as emergency operating of all sorts, needs as much or more physical care and training as would a purely physical ordeal, and, if we are to be relied upon fully by our government and public, our physical preparedness must be as much an accomplished fact as our operating and mechanical ability.

— W3QP

### Interested in A.A.R.S.?

A bulletin describing in detail the aims and functions of the Army Amateur Radio System and outlining what a radio amateur must do to become a member has been prepared by the Radio Aide of the Sixth Corps Area and the Signal Office of that Area. A copy of this bulletin is available to anyone wishing to know more about the interesting work of Army Amateur Radio Stations. Address requests to Philip Haller, W9HPG, Radio Aide, Sixth Corps Area, 503 North LeClair Ave., Chicago, Ill.

The possibilities of 2-Mc. c.w. for traffic work are very great. To those that think high power is needed, the following report may be enlightening: Between September 25th and October 23rd, W9ZBG, using but 90 watts input, has kept thrice weekly schedules on "160 c.w." The Chicago signal has averaged strength-6, always perfectly readable at WIAW, and, of eleven skeds kept, signals were inaudible only twice.

A WIAW practice, which is heartily recommended to all progressive voice operators, is the avoidance of unnecessary abbreviations. Since the new station opened, the operators have given reports as READABILITY . . . . STRENGTH . . . ., which avoids all misunderstanding and argument about the conflicting interpretation of abbreviations. In addition, *bona fide* words with syllables are more understandable (through interference and noise) than the letters of abbreviations. We recommend giving reports, following the words READABILITY and STRENGTH as a good way to demonstrate the best practice in use-of-voice.

### Test Pests

Are you a test pest? These creatures shout "hello test" for hours on the 'phone bands just to hear themselves talk. Then there is the lower type of test pest who parks on a crowded c.w. frequency and sends for his own amusement. This type is one that arouses the ire of any ham, especially when on his own frequency or that of a station being worked. Some of these "bugs" are plain ignorant of the havoc they create. Others know they are causing QRM, but just don't care. If only the monitoring stations would send out little pink slips for such actions! Then ham radio would lose much of its number one enemy — QRM.

The ignorant test pests are not hopeless cases. They can be taught the error of their ways. They will build and use simple dummy antenna systems while testing. The other type, who don't care, are a tougher problem. There is, of course, a rule regarding superfluous signals that might be invoked! The hams of to-day are always kicking about lost frequencies. Why don't they conserve the kilocycles that they now have? One local 'phone station testing with his antenna on the rig will take up a valuable slice of the band.

The question is — How to make these pests see the light? Other operators can tell them about their poor practice. Give it a try. It's a way to help yourself to better band conditions, as well as to give a boost to the whole fraternity!

— John C. Nelson, W8FU

### O.B.S.

The following is a supplement to the list of A.R.R.L. Official Broadcasting Stations in October *QST* (page 78): W1ATE, W1COL, W1EHT, W1HDJ, W2JDC, W3BHE, W3EKZ, W3OQ, W4FWB, W5MH, W6KTY, W6OCH, W7BOZ, W7EKT, W7FPN, W7GPR, W7GVH, W9JWC, W9OAV, W9RIL, W9WWL, W9YQN, W9YTW.

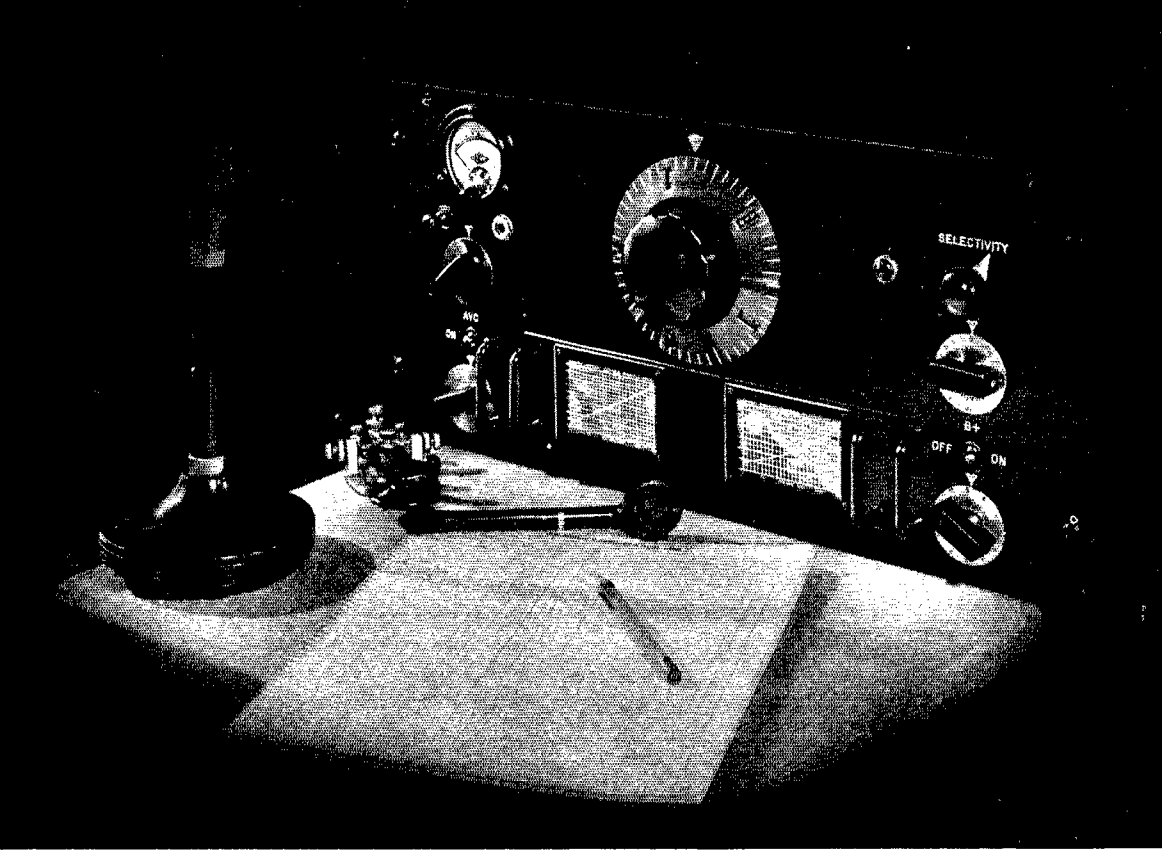

**W**ITH a record of five years of high performance behind it, the HRO is the acknowledged master of difficult operating conditions. Its complete endorsement by men who have spent years mastering the fine points of high-frequency communication is a tribute to its performance of which we are very proud.

*Our new catalog describing our full line of amateur communication equipment will be mailed on request*

NATIONAL  COMPANY

# KENYON QUALITY SWEEPS COUNTRY

JOBBERS EVERYWHERE SWING TO THIS FAST SELLING TRANSFORMER



Wherever you go — Amateurs are talking about KENYON TRANSFORMERS. Long recognized for their outstanding quality . . . it was somehow thought that KENYONS were expensive.

BUT THE TRUTH IS OUT! Dollar for dollar . . . measured by on-the-air-service hours. KENYON TRANSFORMERS are an excellent buy. No wonder amateurs demand them . . . no wonder jobbers everywhere are stocking KENYON to take care of this insistent and growing demand.

Some of the new jobbers recently appointed by Kenyon are listed below. Each of these jobbers has an experienced Ham in charge of amateur equipment. You will find his call letters listed below. Ask for him when you call at any of these jobbers.

- |       |                             |                      |
|-------|-----------------------------|----------------------|
| W5ATB | Radio Inc.                  | Tulsa, Okla.         |
| W9ECY | Auto Equipment              | Denver, Colo.        |
| W9EVD | Beam Radio Co.              | Little Rock, Ark.    |
| W3BE  | G. E. Electric Supply Corp. | Washington, D. C.    |
| W9GFQ | Wholesale Radio Labs.       | Council Bluffs, Iowa |
| W6ITW | Radio Supply Inc.           | Salt Lake City, Utah |
| W7EIN | Spokane Radio               | Spokane, Wash.       |
| W7FNS | Stubbs Electric Co.         | Portland, Ore.       |
| W6LR  | Wholesale Radio Service     | Modesto, Calif.      |
|       | Dow Radio Supply Co.        | Pasadena, Calif.     |

Ask these men why they believe Kenyons are superior in every way!

**BE WISE — KENYONIZE**



**KENYON**  
 TRANSFORMER CO., INC.  
 340 BARRY STREET • NEW YORK, N. Y.  
 Export Department: 25 Warren St., New York, N. Y.

## ELECTION NOTICES

To all A. R. R. L. Members residing in the Sections listed below: (The list gives the Sections, closing of receipt of nominating petitions for Section Manager, the name of the present incumbent and the date of expiration of his term of office.) This notice supersedes previous notices.

In cases where no valid nominating petitions have been received from A. R. R. L. members residing in the different Sections in response to our previous notices, the closing dates for receipt of nominating petitions are set ahead to the dates given herewith. In the absence of nominating petitions from Members of a Section, the incumbent continues to hold his official position and carry on the work of the Section subject, of course, to the filing of proper nominating petitions and the holding of an election by ballot or as may be necessary. Petitions must be in West Hartford on or before noon of the dates specified.

Due to resignations in the Alaska and Louisiana Sections, nominating petitions are hereby solicited for the office of Section Communications Manager in these Sections, and the closing date for receipt of nominations at A. R. R. L. Headquarters is herewith specified as noon, Tuesday, January 2, 1940.

Section	Closing Date	Present SCM	Present Term of Office Ends
San Diego	Dec. 1, 1939	Howard K. Breedlove	Dec. 16, 1939
Brit. Col.*	Dec. 1, 1939	J. Hepburn, Jr.	Dec. 20, 1939
So. Texas	Dec. 15, 1939	Dave H. Calk	Dec. 23, 1939
Alaska	Jan. 2, 1940	Leo E. Osterman (resigned)	.....
Philippines	Jan. 2, 1940	George L. Rickard	Oct. 15, 1938
Indiana	Jan. 2, 1940	Noble Burkhardt	April 15, 1939
Idaho	Jan. 2, 1940	Carl Eichelberger	June 15, 1939
Louisiana	Jan. 2, 1940	Eugene H. Treadaway (resigned)	.....
Virginia	Jan. 2, 1940	Charles M. Waff, Jr.	Jan. 17, 1940
Alberta*	Feb. 1, 1940	C. S. Jamieson	Feb. 18, 1940

\* In Canadian sections nominating petitions for Section Managers must be addressed to Canadian General Manager Alex Reid, 169 Logan Ave., St. Lambert, Quebec. To be valid such petitions must be filed with him on or before the closing dates named.

- You are hereby notified that an election for an A. R. R. L. Section Communications Manager for the next two-year term of office is about to be held in each of these Sections in accordance with the provisions of the By-Laws.
- The elections will take place in the different Sections immediately after the closing date for receipt of nominating petitions as given opposite the different Sections. The Ballots mailed from Headquarters will list in alphabetical sequence the names of all eligible members nominating any member of the League in the Sections named in the Sections concerned. Ballots will be mailed to members as of the closing dates specified above, for receipt of nominating petitions.
- Nominating petitions from the Sections named are hereby solicited. Five or more A. R. R. L. members residing in any Section have the privilege of nominating any member of the League as candidate for Section Manager. The following form for nomination is suggested:

(Place and date)  
 Communications Manager, A. R. R. L.  
 38 La Salle Road, West Hartford, Conn.

We, the undersigned members of the A. R. R. L. residing in the . . . Section of the . . . Division hereby nominating . . . as candidate for Section Communications Manager for this Section for the next two-year term of office.

(Five or more signatures of A. R. R. L. members are required.)  
 The candidates and five or more signers must be League members in good standing in the Section and be thrown out as invalid. Each candidate must have been a licensed amateur operator for at least two years and similarly, a member of the League for at least one continuous year, immediately prior to his nomination or the petition will likewise be invalidated. The complete name, address, and station call of the candidate should be included. All such petitions must be filed at the headquarters office of the League in West Hartford, Conn., by noon of the closing date given for receipt of nominating petitions. There is no limit to the number of petitions that may be filed, but no member shall sign more than one.

Members are urged to take initiative immediately filing petitions for the officials for each Section listed above. This is your opportunity to put the man of your choice in office to carry on the work of the organization in your Section.

— F. E. Handy, Communications Manager

## ELECTION RESULTS

Valid petitions nominating a single candidate as Section Manager were filed in a number of Sections, as provided in our Constitution and By-Laws, electing the following officials, the term of office starting on the date given.

Eastern Florida	Carl G. Schnal, W4PEI	Oct. 15, 1939
Missouri	Miss Letha Allendorf, W9QUD	Oct. 19, 1939
Nevada	Edward W. Heim, W6BIC	Nov. 1, 1939
Oklahoma	Russell W. Battern, W5GFT	Nov. 1, 1939
Eastern New York	Robert E. Haight, W2LU	Nov. 1, 1939

In the West Virginia Section of the Roanoke Division, Mr. W. D. Tabler, W8OXO, and Mr. Robert Ramey, W8PBR, were nominated. Mr. Tabler received 85 votes and Mr. Ramey received 32 votes. Mr. Tabler's term of office began September 18, 1939. Since elements of this election resulted in protest, the West Virginia office was declared vacant by the Executive Committee, and at this writing a run-off election is in progress with the same candidates in the field, further result to be announced next month.

In the Maryland-Delaware-District of Columbia Section of the Atlantic Division, Mr. Hermann E. Hobbs, W3CIZ, and Mr. Frank Lyon, W3HAL, were nominated. Mr. Hobbs received 112 votes and Mr. Lyon received 93 votes. Mr. Hobbs' term of office began October 17, 1939.

(Station Activities on page 96)



# One of a Kind....

In the transmitting field there is no type of design or manufacture more exacting and painstaking than that of special equipment. For years HARVEY has worked in this field producing "one of a kind" units ranging from tiny portable 2-way emergency units to powerful 1000 watt transmitters.

Into every job has gone unlimited research, and planning, in an effort to make each unit do its job and do it well.

Out of this experience has grown the ability to build outstanding equipment rapidly and at a moderate cost.

Shown at right is an excellent example of what HARVEY can do in the way of special equipment. This transmitter, designed for rough, expeditionary service in extreme climates, has an input of 800 watts telephone and telegraph and employs both electron coupled and crystal controlled oscillator. In the RF chassis view below, note the five mounted crystals at left, which may be switched individually from the front panel. It is features like these plus sound engineering that make HARVEY equipment a leader in the field.

If you have any problems regarding special commercial equipment, we will be glad to discuss them with you. Or if you are interested in standard transmitters, write for our general catalog.

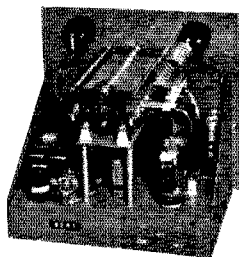

RF Section

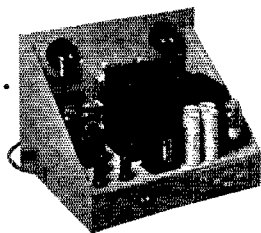

Modulator and Speech Amplifier

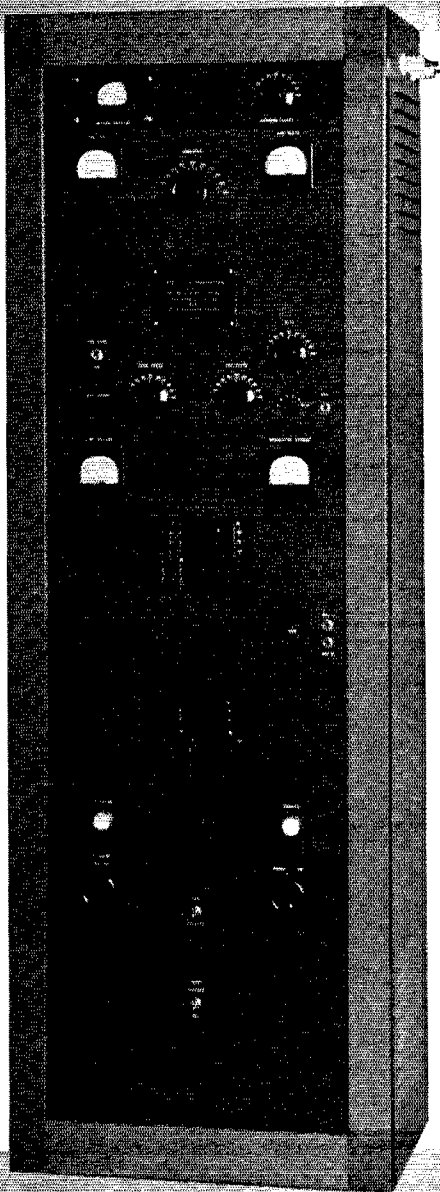

## HARVEY RADIO

**LABORATORIES, INC.**  
**25 THORNDIKE ST.**  
**CAMBRIDGE, MASS.**

Export: 25 Warren St., New York City

# Can you pick the PERFECT CRYSTAL?

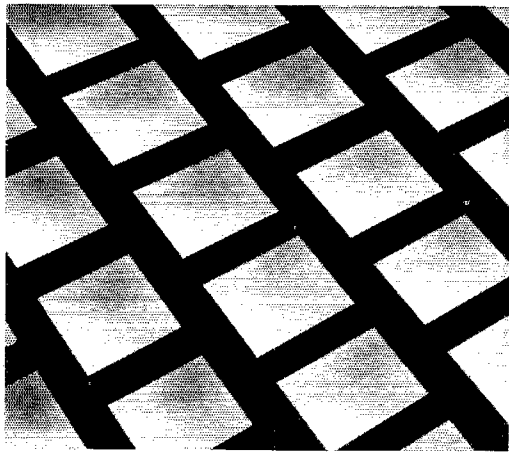

One or more of these crystals may be a reject...because certain quality requirements specified by Monitor have not been met. But can you pick the perfect crystal? Monitor does it with nearly ten years experience plus a series of twenty to thirty rigid examinations. *And in not one test can a Monitor crystal be deficient!*

Monitor has ground and tested thousands of crystals...put them through every kind of performance test to assure you superior crystal control. Yet this care in manufacture costs you nothing extra. It's a Monitor feature that guarantees you the highest possible quality in crystals—a feature that has made Monitor the preferred crystal for commercial as well as amateur installations all over the world.

Monitor crystals are available in various cuts and prices covering all frequencies in the amateur and commercial bands. Regardless of your particular requirements, Monitor gives you *quality higher than the price!*

Available at your dealer's or write direct to us.

# MONITOR

Piezo  Products Co.

1138 MISSION ST., SOUTH PASADENA, CALIF.

76

## “Dish-Type” Construction

(Continued from page 28)

the positive high-voltage terminal are new safety items made by Millen. The barriers between the contacts of the terminal strip prevent accidental short-circuits as well as personal contact. The high-voltage terminal leaves no metal exposed after connection has been made. The sections are threaded together so that an unexpected strain on the connecting wire will not pull the connection apart.

### Wiring

It is always a good plan to make sure that all the required holes are drilled in the chassis before starting the assembly because it is often difficult to drill additional holes after the apparatus is mounted. The holes which will be required for wires passing through the chassis should not be overlooked.

In doing the r.f. wiring, care should be taken to keep it as symmetrical as possible. In forming the long wires between the neutralizing condensers and the tank-condenser stators, the lengths should be made identical. The wire connecting to the rear condenser stator should go directly in a straight line, while the one going to the front stator section may be bent to make up for the difference in distance between the neutralizing condensers and the two stators. The plate leads to the tube should be tapped on these long wires at points which will make the wire length between neutralizing condenser and plate and between tank condenser and plate equal on each side.

The positive high-voltage lead, run inside the chassis with high-voltage cable, comes up through a feed-through insulator near the plate choke.

The leads from the neutralizing condensers to the grid terminals are crossed over before they pass through small feed-through points mounted in the partition. The grid r.f. chokes are self-supporting between the tube grid terminals and feed-through points in the chassis which carry the biasing leads inside to the individual grid leaks. Filament wires are run through  $\frac{3}{8}$ " holes lined with rubber grommets.

Inside the chassis, the leaks and meter-shunting resistances are supported on fibre lug strips. The leads going to the switch should be soldered in place, formed into cables and the other ends connected to the switch on the panel as the last operation before putting the panel in place. The panel is fastened to the chassis with six 8-32 flat-head machine screws after holes have been drilled and tapped in the folded edges of the chassis.

A pair of Millen type 39001 45-degree flexible shaft couplings with Isolantite insulation is used to permit right-angle control of the plate tank condenser shaft. One of these is fitted on the shortened condenser shaft while the other is placed on the extension shaft which runs through a bearing in the chassis to the one in the front

# CHRISTMAS GREETINGS



## from Taylor Tubes



ONCE MORE the air is filled with the comforting message of Christmas. Into the hearts of everyone, the Christmas spirit brings a warm message of Peace, Good-Fellowship and Cheer. To radio amateurs,

in every country of the world, this spirit of brotherhood means a great deal and it is lived up to by them, faithfully day in and day out, through every season of the year. We, here at Taylor Tubes, know and respect this vital comradeship which the magic of amateur radio has made possible. To us—you, our loyal friends—represent a trust which we zealously and honestly serve. Through Taylor Tubes the price of radio transmitting tubes has been brought within the reach of all. Through us an absolute guarantee of satisfaction has been made a universal practice. A friendly cooperative engineering staff has constantly served you. Through Taylor research at our plant new and more efficient tubes have been created and placed at your service and here at Taylor Tubes the same spirit, which a QSO on the ham bands represents, completely governs our daily actions. It is small wonder then that we salute our many friends throughout the radio world, wishing them peace and the continued joy of close amateur friendship.

*Yes, and to those men who so ably serve you—your Radio Parts Distributors—we extend our sincere thanks for carrying to the radio amateur, Taylor Tubes and the Taylor policy of fair play.*

### TO DAD, MOTHER, WIFE OR SWEETHEART

WE SUGGEST, as the ideal gift, Taylor transmitting tubes. Every radio amateur will welcome any of the many transmitting tube types made by Taylor Tubes. We will be happy to help you select such a gift, or see the parts distributor who serves your amateur, he will gladly help you.

### BIG TAYLOR CHRISTMAS GIFT READY

YES, that big new 1940 Taylor Manual and Catalog will be ready for you before Christmas. Get your copy at your parts distributor free, or send us five cents in stamps or coin and we will mail it direct. Chock-full of New circuits—New tube uses—New tubes and all the latest transmitter data you want. Profusely illustrated with circuit diagrams, graphs and photos.

*Merry Christmas and a Happy New Year*

FRANK HAJEK W9ECA

WARREN TAYLOR

BILL BISHOP W9UI

JOE HAJEK

REX MUNGER W9LIP

*"More Watts Per Dollar"*

TAYLOR TUBES, INC., 2341 WABANSIA AVE., CHICAGO, ILLINOIS

**GET MORE** *out of*  
*your* **STATION...**

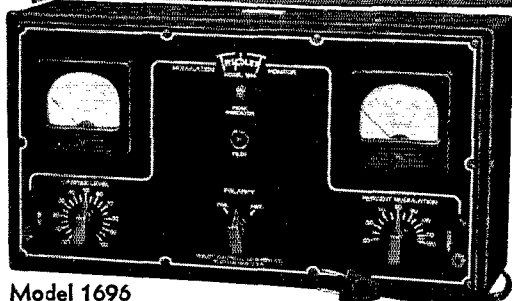

Model 1696

with **TRIPLET**

## MODULATION MONITOR

... AT A PRICE!

- Usable on All Amateur Bands ● Permits Compliance With Federal Regulations ● 110 Volt AC 60 Cycle Operation ● Two Meters — One for Carrier, One for Per Cent Modulation ● Calibrated Modulation control for neon flasher from 50% to 120%. Polarity switch permits checking positive and negative peaks. Tip Jacks for Phone Connection ● Uses Vacuum Tube Rectification ● RED ● DOT Lifetime Guaranteed Meters. In Metal Case. DEALER NET PRICE **\$33.00**

Also available as rack panel mounting unit. DEALER NET PRICE... **\$33.67**

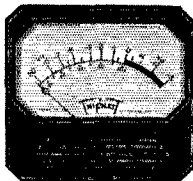

Model 426

## V. U. METER

Volume Unit Meters for measurement of sound or noise levels. Carefully determined dynamic, electrical and other characteristics. Steady state reference of 1 milliwatt. Impedance of circuit across which instrument is calibrated 600 ohms.

WRITE FOR CATALOG  
Section 2512 Harmon Ave.

THE TRIPLET ELECTRICAL INSTRUMENT CO.  
Bluffton, Ohio

panel. Between the two couplings a short length of connecting shaft is used. The length of this section and the position of the coupling on the condenser shaft should be adjusted carefully for true running; otherwise an undue strain may be placed on the coupling causing it to part. The collar on the shaft inside the chassis may be set to take care of end thrust.

No difficulties in neutralizing nor with parasitics was encountered in tuning up this amplifier, quite probably results of care in wiring symmetry and the difference in lengths of plate and grid leads. Both grid and plate currents checked the same within less than ten per cent.

The meter when switched to read grid current forms a good neutralizing indicator. Both neutralizing condensers should be kept at equal settings and adjusted simultaneously until the grid current remains perfectly steady as the plate tank is tuned through resonance. When not neutralized, there will be a pronounced dip in grid current at resonance. Neutralizing is, of course, always done with plate voltage removed.

The amplifier requires a driver delivering 25 to 40 watts for high-efficiency operation. An 809 in this case provided plenty of margin. Where high efficiency in c.w. operation is of less importance than high-power gain, the driving requirements will be considerably reduced.

If the amplifier is to be protected with fixed bias against failure of excitation, the grid-leak resistance of each tube should be adjusted so that the total grid voltage under operating conditions will be not less than 125 volts without exceeding the maximum grid-current rating of 25 ma. per tube when the amplifier is loaded to rated plate current.

## A Four-Tube Superhet

(Continued from page 19)

setting the oscillator coil so that it gives the proper amount of output. This is done by moving the plate coil away from the grid coil (to reduce output) or by moving it closer (to increase output). It will be found that the signal will be loudest at some one setting of the mixer gain control — if it occurs with the control nearly all the way off, too much oscillator voltage is present and the oscillator plate coil should be moved away from the grid coil. If the maximum signal is obtained with the control fully advanced, not enough oscillator voltage is available, and the oscillator plate control should be moved closer. A setting of the mixer gain control between half and three-quarters full is about right.

With all these things working smoothly, the i.f. can be trimmed up a bit. Tune in a commercial signal sending V's and, with the b.f.o. off, advance the i.f. gain control until the i.f. oscillates, as shown by a beat note with the incoming signal. The plate tuning condenser of the input i.f. transformer can then be adjusted to the point where the i.f. gain control must be advanced the farthest

Dear Family:—  
 If you really want to  
 know what I want for Xmas,  
 see what I have checked  
 on this list.

-----  
 (SIGN YOUR OWN NAME HERE)

**TEAR  
 OUT  
 THIS  
 PAGE**

and leave it  
 casually on the  
 dining room  
 table.

(Catalog Numbers from new  
 Johnson Catalog 966J)

- |   |  |
|---|--|
| <input type="checkbox"/> 1 100DD90 CONDENSER<br><i>(Going to drive this from center, like I saw in Nov. QST, Page 42)</i> | <input type="checkbox"/> 1 set 680 Series INDUCTORS  |
| <input type="checkbox"/> 2 N250 Neut. CONDENSERS<br><i>(I'll lay 'em down — save lotsa room)</i>                          | <input type="checkbox"/> 1 set 660 Series INDUCTORS  |
| <input type="checkbox"/> 1 10-20 METER "Q" BEAM<br><i>(Will I ever get out with that!)</i>                                | <input type="checkbox"/> 1 150ED30 CONDENSER   |
| <input type="checkbox"/> (A few bucks for Johnson Insulators 'n things will help no end.)                                 | <input type="checkbox"/> 2 210 SOCKETS   |
| <input type="checkbox"/> .....  | <input type="checkbox"/> 1 754 R.F. CHOKE  |
| <input type="checkbox"/> .....  | <input type="checkbox"/> 1 100HD15 CONDENSER.<br><i>(That new "H" is sure F.B. I'll throw out that klunk in my exciter.)</i> |
| <input type="checkbox"/> .....  | <input type="checkbox"/> .....   |
| <input type="checkbox"/> .....  | <input type="checkbox"/> .....   |

*Private and Aside*  
**TO THE FAMILY**

If you haven't that swell new catalog 966J, hurry up and get it from your JOHNSON jobber or direct.

"To make him happy, give him some of these real 'necessities of life'. It will make a bigger hit than a bushel of sox or ties. He wants the best he can get for his rig, and that means JOHNSON in any Ham's dictionary."



**E. F. JOHNSON CO.**

WASECA, MINNESOTA

EXPORT: 25 WARREN ST., NEW YORK, N. Y.

**"MANUFACTURERS OF RADIO TRANSMITTING EQUIPMENT"**

**6000**  
Volts AC-DC **10**  
MEG OHMS **12**  
AMPERES

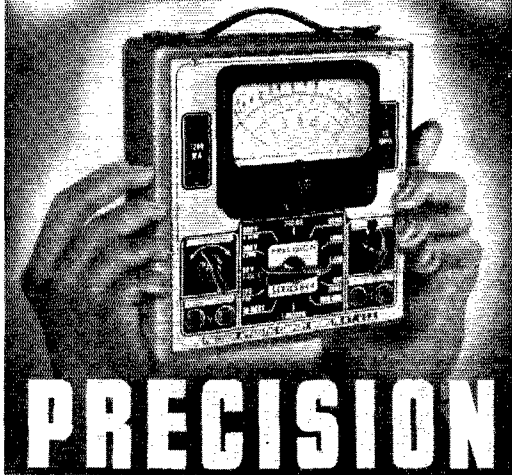

## Series 844-34 Range AC-DC VOLT-OHM-DECIBEL-MILLIAMMETER

**PROVIDES** complete facilities for obtaining all measurement requirements for Amateur, Service, Laboratory, Television and Industrial use.

- Large 4 $\frac{1}{2}$ " Precision square type meter; D'Arsonval type; "bridge type" construction; 400 microamperes full scale sensitivity.
- Precision wire wound shunts and matched molded metallized multipliers of an accuracy within 1%.
- Individually calibrated and sealed against laboratory standards assuring 2% DC and 3% AC overall accuracy.

### SPECIFICATIONS

- ★ SIX A.C. and D.C. VOLTAGE RANGES at 1000 ohms per volt: 0-12; 0-60; 0-300; 0-600; 0-1200; 0-6000 volts.
- ★ SIX D.C. CURRENT RANGES: 0-1.2; 0-12; 0-60; 0-300; 0-1200 MA; and 0-12 Amperes.
- ★ FOUR RESISTANCE RANGES: 0-400; 0-100,000; 0-1 Meg.; and 0-10 Megs.
- ★ Provisions for Mounting Ohmmeter Batteries (4 $\frac{1}{2}$  and 45 volts) on inside of case.
- ★ SIX DECIBEL RANGES from -12 to 70DB.
- ★ SIX OUTPUT RANGES: 0-12; 0-60; 0-300; 0-600; 0-1200; 0-6000 volts.

844-L — Housed in walnut finished hardwood case with carrying handle. Compact in size (7 x 8 x 4). Less batteries and test leads. Net **\$22.95**

844-P — Closed type with removable cover and tool compactment. . . . . **\$24.95**

**PRECISION TEST EQUIPMENT**  
Standard of Accuracy SEE THEM AT YOUR JOBBER

**PRECISION APPARATUS COMPANY**  
647 Kent Avenue Brooklyn, New York  
Export Division: 458 Broadway, New York City, U. S. A.  
Cable Address: Morhanex

for oscillation. This will put the i.f. in exact tune. If the gain control does not have to be advanced nearly all the way for oscillation, even with everything in exact tune, loosen the twist of the wire from the plate to the 6K7 grid until it does.

The final step is the adjustment of the antenna coupling and the mixer regeneration. The antenna coupling, with any particular antenna, should be the maximum that can be used that still allows the mixer to be tuned fairly sharply and gives no trouble from image response. If images show up (on the 14-Mc. band most likely), the coupling should be reduced, by cutting down the number of turns or by moving the coil farther away from the grid coil.

For mixer regeneration, the jumper used to replace the plate coil is removed and a small coil is added. This can be twisted around inside the grid coil until the proper degree of regeneration is obtained. It may be possible to make the mixer oscillate by advancing the mixer gain control to the full-on position, but normally this degree of regeneration will not be required. Usually only a small amount will be necessary to boost the signal a bit and also increase the input selectivity. The regeneration was left out on the 7- and 3.5-Mc. bands because it wasn't necessary. On the bands where regeneration is used, it will be found that the mixer oscillates freely with the antenna removed, but there should be no trace of oscilla-

### COIL DATA FOR THE FOUR-TUBE SUPERHET

- 3.5 Mc.:  $L_1$  — 7 turns No. 24 d.c.c. close-wound next to  $L_2$ .  
 $L_2$  — 27 turns No. 24 d.s.c. wound to occupy 1 $\frac{1}{2}$  inches, tapped at the 25th turn.  
 $L_3$  — none. Wire jumper used.  
 $L_4$  — 6 turns No. 20 enam. wound to occupy  $\frac{3}{8}$  inches,  $\frac{1}{2}$  inch away from  $L_5$ .  
 $L_5$  — 14 turns No. 20 enam. wound to occupy 1 inch, tapped at the 13th turn.
- 7 Mc.:  $L_1$  — 6 turns No. 24 d.c.c. close-wound  $\frac{1}{4}$  inch from  $L_2$ .  
 $L_2$  — 19 turns No. 20 enam. wound to occupy 1 $\frac{1}{4}$  inches, tapped at 11th turn.  
 $L_3$  —  $\frac{1}{2}$  turn No. 18 enam., mounted inside of coil form.  
 $L_4$  — 2 turns No. 20 enam. close-wound  $\frac{1}{2}$  inch from  $L_5$ .  
 $L_5$  — 10 turns No. 20 enam. spaced to occupy 1 inch, tapped at 5th turn.
- 14 Mc.:  $L_1$  — 6 turns No. 24 d.c.c. close-wound  $\frac{1}{4}$  inch from  $L_2$ .  
 $L_2$  — 9 turns No. 18 enam. spaced to occupy 1 inch, tapped at 4th turn.  
 $L_3$  — 1 turn No. 18 enam.  $\frac{1}{8}$ -inch diam., mounted inside of coil form at level of ground end of  $L_2$ .  
 $L_4$  — 2 turns No. 18 enam. close-wound  $\frac{3}{4}$  inches from  $L_5$ .  
 $L_5$  — 6 turns No. 18 enam. wound to occupy 1 $\frac{1}{4}$  inches, tapped at 2nd turn.
- 28 Mc.:  $L_1$  — 3 turns 24 d.c.c. close-wound  $\frac{1}{8}$  inch from  $L_2$ .  
 $L_2$  — 3 turns No. 18 enam. wound to occupy  $\frac{3}{4}$  inches, tapped at 2 $\frac{1}{2}$  turns.  
 $L_3$  — 1 turn No. 18 enam.  $\frac{1}{8}$ -inch diam. inside form at level of ground end of  $L_2$ .  
 $L_4$  — 1 turn No. 18 $\frac{1}{4}$  inch from  $L_5$ .  
 $L_5$  — 2 turns No. 18 enam. wound to occupy  $\frac{1}{2}$  inch, tapped at 1 $\frac{1}{2}$  turns.

All coils wound on 1 $\frac{1}{2}$ -inch forms (Hammarlund SWF), 6-prong for mixer coils, 5-prong for oscillator coils.

*For those who want the best*

**EASIEST  
TO  
DRIVE!**

**6 OUTSTANDING  
FEATURES INSURE  
LONGER LIFE**

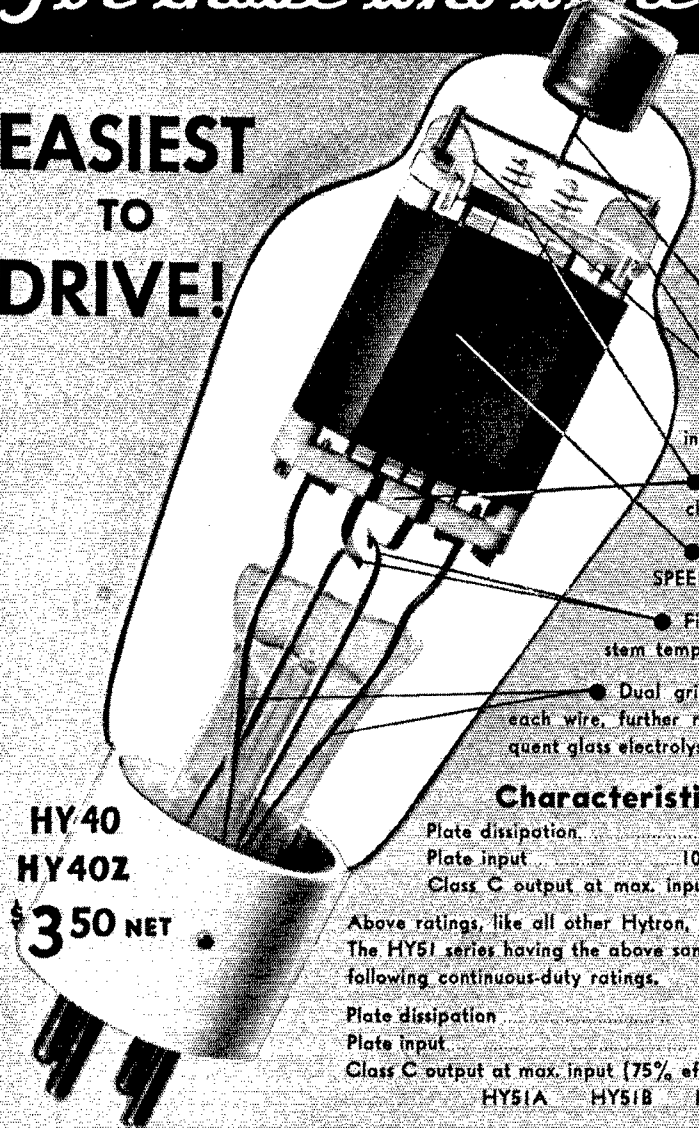

- Short, direct connections to both sides of plate.
- Mica snubbers support elements in dome of bulb — increase strength — absorb shock.
- Lava low-loss insulation used exclusively.
- Heavy, non-warping, over-size SPEER graphite anode.
- Filament heat radiators to reduce stem temperature.
- Dual grid leads to halve grid current in each wire, further reducing stem heating and subsequent glass electrolysis.

**Characteristics of HY40 & HY40Z**

Plate dissipation.....	40 max. watts
Plate input.....	1000 max. watts and 115 max. ma.
Class C output at max. input (75% eff.).....	86 watts

Above ratings, like all other Hytron, are for continuous-duty operation. The HY51 series having the above same outstanding features carries the following continuous-duty ratings.

Plate dissipation.....	65 max. watts
Plate input.....	1000 max. volts and 175 max. ma.
Class C output at max. input (75% eff.).....	131 watts

HY51A	HY51B	HY51Z	\$4.50 net
-------	-------	-------	------------

All Hytron transmitting tubes are economically priced and have been designed for extremely efficient operation with low-cost radio parts. Thus the amateur makes a dual saving. Further advantage is that Hytron tubes require no voltages in excess of 1000 for full output.

exclusive manufacture of radio tubes. The Hytron Corporation, the originator of the now popular *Bantam*\* "GT" series tubes as well as the pioneer of the ultra-small low-drain *Bantam Junior*\* pentodes for wearable hearing aids.

Hytron transmitting and special purpose tubes are backed by more than 18 years continuous experience in the

Hytron tubes available at leading distributors.



**HYTRONIC LABS.**  
23 New Derby St., Salem, Mass.

**A DIVISION OF THE  
HYTRON CORP.**

**Manufacturers of Radio Tubes Since 1921**

# ABBOTT • DK2 • 2½ METER TRANSCEIVER

*The Xmas Gift  
He Will Appreciate*



List Price **\$27.50**

Less Tubes and Batteries 40% Discount to Amateurs

**GENERAL:** The DK2 is a completely self-contained 112 mc radiophone transmitter and receiver, for use in your car, plane, boat, or while being carried, for portable work. It is very simple to operate. The working range is between 2 to 30 miles depending on the location. Astonishing results have been obtained.

#### SPECIFICATIONS

**CASE:** Size 11½" long x 9½" high x 6½" wide, grey wrinkle finish metal, heavy leather handle, heavy leather case. All batteries are self-contained in case. Removable side panel for easy access to the batteries and tubes.

**FREQUENCY:** Will cover 112 mc to 118 mc (amateur 2.5 meter band).

**BATTERY REQUIREMENTS:** Three 45 volt B batteries like Burgess 5308, and four No. 6 dry cells, or two Burgess 2F2H batteries.

**TUBES USED:** One type 6J5GT<sub>x</sub>, one type 6G6G.

**SHIPPING WEIGHT:** 12 pounds.

#### Order from Your Nearest Distributor

Thomas H. Brown	.....	New Haven, Conn.
Beem Radio Co.	.....	Little Rock, Ark.
Burstein-Applebee Co.	.....	Kansas City, Mo.
Cameradio Co.	.....	Pittsburgh, Pa.
Coast Electric Co.	.....	San Diego, Calif.
Davega-City Radio	.....	New York, N. Y.
Dutch Village Radio Co.	.....	Portland, Oregon
Harrison Radio	.....	New York, N. Y.
Iowa Radio Corp.	.....	Des Moines, Iowa
H. Jappe Co.	.....	Boston, Mass.
Newark Electric Co.	.....	Chicago, Ill.
Olsen Radio Supply	.....	San Antonio, Texas
Pasadena Radio Supply	.....	Pasadena, Calif.
Radio Exchange	.....	El Paso, Texas
Radiolab	.....	Kansas City, Mo.
Radio Shack Corp.	.....	Boston, Mass.
Southwest Radio Supply	.....	Dallas, Texas
Stallman of Ithaca	.....	Ithaca, New York
Straus-Frank Co.	.....	Houston, Texas
Sun Radio Company	.....	New York, N. Y.
Eugene G. Wile	.....	Philadelphia, Pa.
Zack Radio Supply	.....	San Francisco, Calif.

If not yet stocked we will temporarily fill orders direct

BULLETIN ON REQUEST

**ABBOTT INSTRUMENT, INC.**  
51 Vesey Street New York City

tion with the antenna on, except with the gain control in the fully-advanced position. If the mixer refuses to oscillate, be sure that the plate coil and grid coil are wound in the same direction, with the grid and plate connected to opposite ends.

It will be found that peaking the mixer bandset condenser "pulls" the oscillator to some extent, particularly on the 14- and 28-Mc. bands. This is a characteristic of all capacity-coupled mixer-h.f.o. combinations, and there doesn't seem to be much that can be done about it. Probably an untuned Class-A amplifier between oscillator and mixer would do the trick — making, in effect, an electron-coupled oscillator out of the 6J5 — but that's something we'll have to try when we get our hands on the receiver again. In any event, when the two circuits have been made to track, there is no reason continually to resonate the mixer handset condenser, and the effect causes no trouble.

In the receiver described, there was apparently some coupling between the b.f.o. condenser and the power-supply cable, which was cleaned up by putting a small shield of thin aluminum over the condenser (not shown in the photographs). Another trace of body-capacity was cleaned up by putting an r.f. filter in the 'phone leads.

In operation, the receiver has a remarkably low noise level, due to the 1852 mixer, and weak signals seem to stand right out. On strong signals, it is necessary to back off on the gain controls for comfortable reception.

## On the Ultra-Highs

(Continued from page 31)

28 to 56 Mc. in the conventional manner. Antenna coupling is another hairpin similar to that used in the plate circuit. With 90 ma. at about 600 volts, this haywire doubler puts 15 very respectable watts into the antenna on 112,100 kc. Don't forget the low plate efficiencies obtaining at this frequency. It is well to run a stage operated in this way at not over 60% of the manufacturer's ratings for the tube used.

#### GENERAL:

**SINCE** getting out some preliminary correspondence announcing this column, many letters have been received from 56-Mc. men all over the country. The letters contain many interesting reports and suggestions and are appreciated, no end. Due to the limited time available, no effort has been made to analyze or report on current conditions. This will be done in the future, however, to whatever extent you deem it advisable. To all who are interested in u.h.f. activity we say that this is your column. It will contain whatever you wish it to contain — but we **MUST** have your cooperation. This department is devoted entirely to u.h.f. and to you as u.h.f. enthusiasts. Your interest, as evidenced by your reports of local conditions and activity, is what will make it "tick!"



# STANCOR

## GENERAL UTILITY AMPLIFIERS

FOR DRIVER, MODULATOR and  
PUBLIC ADDRESS SYSTEMS

THE scientific advancements contained in Stancor's 1940 line are attracting the attention of the entire industry. We illustrate a few here with brief descriptions. All are more fully illustrated and described in the new 1940 Stancor Hamanual now available upon request at your jobbers. Ask for a copy.

**STANCOR 415 AMPLIFIER KIT** — Two channel electronic mixing, three inputs, dual tone control, 2A3's in 15 watt Class AB power amplifier. Net price less accessories . . . . . **\$3150**

**STANCOR 430 AMPLIFIER KIT** — Two channel electronic mixing, three inputs, dual tone control, 6L6's in 30 watt Class AB1 power amplifier. Net price less accessories . . . . . **\$3350**

**STANCOR 460 AMPLIFIER KIT** — Two channel electronic mixing, three inputs, dual tone control, 6L6G's in 60 watt Class AB2 power amplifier. Net price less accessories . . . . . **\$3700**

*Get Your*

### STANCOR HAMANUAL

*Free . . . At Your Jobber*

This Fourth Edition thoroughly describes a host of new Transmitters and Amplifiers. Write us for dealer's name.

**STANDARD TRANSFORMER  
CORPORATION**

1500 NORTH HALSTED STREET, CHICAGO



**STANCOR**

# WHAT'S IN THE ANTENNA BOOK?

● ● ● In *Chapter 1* we find this or that type of antenna is better than another due to the nature of radio waves and the way in which they travel . . . *Chapter 2* is devoted to an explanation of how the strength of the field radiated from a section of wire carrying radio-frequency current depends upon the length of the wire and the value of the current flowing in it . . . *Chapter 3* clearly explains how the earth acting as a reflector affects the performance of an antenna, particularly with respect to its directive properties and how we must take this into consideration in its design . . . Figures, design and best methods of adjustment for feed systems to transport power from the transmitter to the antenna with a minimum of loss, will be found in *Chapter 4* . . . In *Chapter 5* radiation patterns and feeding systems for our old standby the half-wave antenna are given . . . If interested in long single wire antennas, in *Chapter 6* we find all the necessary charts and tables to design one best suited for our needs . . . *Chapter 7* gives us the data for the antenna that we can operate on several bands . . . Driven arrays and phase systems, their adjustment, with charts for directivity are fully covered in *Chapter 8* . . . Our next *Chapter, 9*, is devoted to parasitic arrays and the necessary dope for the design and adjustment of two-element to four-element beam antennas . . . As in the other chapters, all the necessary charts and tables are given in *Chapter 10* for the design of the long wire "V" antenna . . . The rhombic, or diamond, antenna is so adequately covered in *Chapter 11* that one may gain a thorough understanding as well as the practical information necessary to have such an arrangement . . . The problem of finding space for an antenna for 160 meters is minimized in *Chapter 12* by giving methods for putting up such an antenna in limited space . . . It having been found that directive systems will extend the operating range on 56-Mc. to a remarkable degree, such antenna systems are described in complete detail in *Chapter 13* . . . *Chapter 14* is devoted to special antenna systems. Flat lines for two bands, three feeder antennas, transmitting loops, dummy antennas, etc. . . . To efficiently utilize our directive arrays we need to be able to determine directions and also true north from our own location. Both of these problems are adequately covered in *Chapter 15* . . . Suggestions and details on the construction and support of the antenna and feeder systems will be found in *Chapter 16* . . . *Chapter 17* gives us proven methods of supporting and rotating beam antennas, as well as information on drive mechanisms, feeding and determining the direction that the signal is aimed . . . We find in *Chapter 18* special antennas for receiving, as well as methods for using our transmitting antenna for this purpose.

50 cents, postpaid. (No stamps, please)

**A. R. R. L.**

WEST HARTFORD

CONN.

To all five-meter men we say, "Don't give up the ship" for the winter just because skip-DX is not so frequent as in the summer. Don't forget that last fall and winter there were a number of good openings, though for shorter periods and over smaller areas than during the early summer peaks. And the band has not been so dead, this fall, as some have been led to believe. On Oct. 7th, W4FPC, St. Petersburg, Fla., worked W1CGY, W1IJ, W9ARN, W9RGH, and W9ZHB that we know of; and W5AJG of Dallas, Texas, worked W3DBC, W3BZJ, W3EEN, W8RUE, and heard W2HWX and W8NQO. W6QLZ of Phoenix, Ariz., reports that for several hours during the middle of the day recently he has been hearing commercial services operating on frequencies up to 52 Mc. in New York and New England, with particularly strong peaks on Oct. 28th. No, gang, not all the u.h.f. DX is worked in May and June!

## The "Portable Five"

(Continued from page 53)

On account of the small size of the chassis it will be necessary to use the MIP sockets (the plate molded in the socket) or else remove regular sockets from their mounting plates and mount directly in the chassis, in which case the holes must be cut to fit the sockets used.

### Chassis

The chassis is formed from No. 16 gauge or lighter aluminum, cut and drilled according to Fig. 2. To fold, make two little blocks from one-inch stuff, so-called, the exact size of the top of the chassis, 3 by 3½ inches, and clamp the sheet, with the corners cut away of course, running a few wood-screws through one block into the other, passing through the socket holes. Bend the sides down and a few taps with a hammer will square things up ship-shape. Be sure to bend in the proper direction so as not to reverse the layout — unless you prefer it reversed.

### Coils

The coils are wound on 1½-inch coil forms (like those of the "Runt Sixty") and the following are suggested. You may wish to experiment, however, to determine the best combination for your own antenna system.

#### 80 meters:

- $L_1$  — 25 turns No. 18 enameled, close-wound, length about 1¼". Inductance 19  $\mu$ h.
- $L_2$  — 9 turns No. 18 enameled close-wound

#### 40 meters:

- $L_1$  — 20 turns No. 18 enameled, close-wound, length ⅞". Inductance 14.4  $\mu$ h.
- $L_2$  — 7 turns No. 18 enameled, close-wound

#### 20 meters:

- $L_1$  — 8 turns No. 18 enameled spaced to occupy 1½". Inductance 1.6  $\mu$ h.

**QST**  
*Listen all hams!*



Why be satisfied with less when tubes with SPEER Graphite Anodes give you all of these advantages? SPEER Graphite Anodes are sold only to tube manufacturers. Write for list and Anode Booklet No. 80.



**SPEER CARBON COMPANY**

ST. MARYS, PA. CHICAGO CLEVELAND DETROIT MILWAUKEE NEW YORK PITTSBURGH

Here it is!

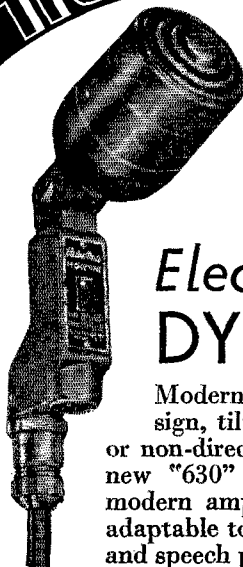

New #630

## Electro-Voice DYNAMIC

Modern in its functional design, tiltable for directional or non-directional pick-up, this new "630" is suitable for all modern amplifiers . . . readily adaptable to high fidelity music and speech pick-up.

Rugged in construction . . . made entirely of metal and bakelite, it is impervious to heat, temperature changes, rough handling and salt air . . . a "natural" for service in tropical climates.

- ★ FREQUENCY RESPONSE: 40-9000 c.p.s. with rising characteristic on upper end of curve.
- ★ OUTPUT: -56 db. (open line). Standard output impedances include Hi-Z, direct-to-grid.
- ★ VOICE COIL: Hard drawn aluminum wire for lightness, insulated with Polystyrene.
- ★ MAGNETIC CIRCUIT: Large alnico magnet with Armco magnetic iron pole pieces.
- ★ DIAPHRAGM: Heat treated Durev.
- ★ TRANSFORMER: Built-in in all models except 50 ohm. Core material has extremely high permeability.

Available in both chromium and light gunmetal finishes. Full equipment includes a three contact locking connector, 20 ft. low capacity cable, on-off switch and tilting stand mounting.

630-GM (gunmetal) list price . . . . . \$25.00

630-C (chromium) list price . . . . . 27.50

See this new "630" at your local radio parts distributor. Write for complete details.

**ELECTRO-VOICE MFG. CO., Inc.**  
1239 SOUTH BEND AVENUE  
SOUTH BEND, INDIANA

Export Division: 100 Varick St., New York, N. Y.—Cables: "Arlab"

$L_2$  — 3 turns No. 18 enameled, same spacing as  $L_1$ .  
In all coils  $L_1$  and  $L_2$  are about  $\frac{1}{8}$ " apart.

### Tuning

You should have some means of judging antenna current, and an indicator costing only a few cents has been described in previous issues.<sup>2</sup> A small rig tuned on the nose may put out more power than a larger one if the latter is inefficiently tuned. In general, tuning consists of adjusting plate and antenna condensers to secure maximum antenna current and minimum plate current. However, to obtain the best *sounding* signal from this or any other transmitter, a monitor is desirable. Frequently the receiver can be used for monitoring, but failing this a monitor such as shown in the *Handbook* can be cheaply assembled.

In spite of its small size and power this transmitter will do surprising work. You can have a lot of fun with amateur radio without working Africa or Australia!

<sup>2</sup> Sutter, "What, No Meters?," *QST*, October, 1938.

### Five Bands

(Continued from page 45)

dial tuning can be used to good advantage, and the slow-motion is far less objectionable than with ordinary one-band tuning arrangements.

Use of this type of tank circuit should prove a big step toward safety in transmitter operation, since with band-changing accomplished entirely from the front of the panel, the need for bringing the operator's hands near high-voltage circuits is eliminated. This should prove a life saver, even for the more cautious operators who try to remember to turn off plate voltage.

Of course, the comments applying to transmitter tanks of the switched and plug-in types apply similarly to these combination units — there must be a dependable insulated coupling between the condenser shaft and the tuning dial, since every metal part of the tank is at high voltage to ground, except when parallel feed is used with the unbalanced arrangement.

### I. A. R. U. News

(Continued from page 59)

less, listening is going to prove quite an interesting way of passing those winter blackout evenings. Already 600 metres has proved itself worth a whirl. . . .'

#### Canada

Not too much discouraged by the ban on transmitting, several Canadian amateur clubs are determined to carry on, with technical development as their main thought. Shielded loops,

A TRIUMPH OF RADIO CRAFTSMANSHIP

A Great New

# HOWARD

At a New Low Price!

**\$39<sup>95</sup>**

COMPLETE WITH  
TUBES & SPEAKER

## Featuring

### NOISE LIMITER

New trigger type circuit which responds to all signals having a steep wave front characteristic. Diminishes all interferences such as caused by automobile ignition systems.

### ELECTRICAL BAND SPREAD

Employs a separate condenser with linear calibration over 8" long covering 340".

### CERAMIC COIL FORMS

Used on ALL oscillator coils—Provides excellent frequency stability.

555 TO 7 METERS—54—43 MC

Complete uninterrupted tuning range.

### SEVEN TUBES

6K8G Mixer Osc., 6SK7 I. F. Amplifier, 6SQ7 Det. and 1st A. F., 6K6G Output, 6C5 B. F. O., 6H8G Noise Limiter., 80 Rectifier.

### FLYWHEEL TUNING

Employing the new HOWARD INERTIA KNOBS achieving fast and smooth tuning. Used on MAIN TUNING and BANDSPREAD.

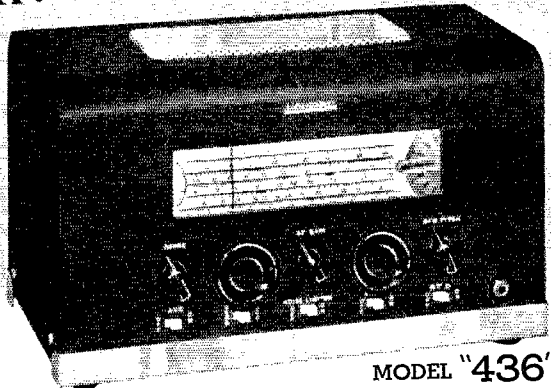

MODEL "436"

Definitely contributing to amateur radio development, the new Howard "436" communication type receiver offers a greater combination of advanced features at so low a cost that it may well be called the greatest value in amateur radio history.

Engineered to new high standards, the Howard "436", with its improved noise limiter, electrical band spreader, inertial fly-wheel tuner and ceramic coil forms, provides amazing sensitivity, selectivity and ease of operation.

Among the many other features found in the "436" are: beat frequency oscillator, iron core I. F. transformers, built-in Jensen electro-dynamic speaker, silver plated shielding, A.V.C., send-receive switch, headphone jack on front panel, doublet or standard antenna connections, and copper plated chassis. Long-wave models and models for special voltages and frequencies available. Export prices slightly higher.

Ask Your Jobber About the Startling New Howard "Progressive Series" Plan

### FOR BATTERY OPERATION

Convenient socket connection on back panel of receiver provides 6 volt operation using the efficient and highly successful Howard type "610" Power Pack. This makes an ideal arrangement for use in car, boat or rural locations where power lines are not available. Same socket may also be used for connecting signal level indicator. Howard type 600 "R" Meter.

*America's  
Oldest  
Radio  
Manufacturer*

### SEND COUPON TODAY!

Howard Radio Co., Dept. Q-12,  
1731-35 Belmont Ave., Chicago, Ill.  
Please send complete technical details about  
the new HOWARD "436". (Coupon may be  
pasted on post card or mailed in envelope.)

NAME \_\_\_\_\_

ADDRESS \_\_\_\_\_

**HOWARD RADIO CO.**  
1731-35 Belmont Ave., Chicago, Illinois

Cable Address  
**HOWARDCO, U.S.A.**

# Midland-Trained AIRLINE RADIO "OPS" are on the job from coast to coast



## HERE ARE THE FACTS

1. Our employment record tops 90%.
2. Our graduates are employed by eleven airlines.
3. We have had more calls for our graduates than we have been able to supply.
4. Indications point to an increased demand in the future.

## SPECIALIZED TRAINING

Midland training in Airline Radio Operating is prepared, approved, and supervised by men from major Airlines. Prepares for first class "fone" and second class telegraph license exams. Includes practical radio experience, broad experience in Airline procedure, meteorology, navigation, aids to air navigation, study of aircraft, touch typing, handling passengers, air mail, express and actual circuit room experience on hot "CW" and "fone" airline circuits. Either straight resident or combination extension-resident training plans available.

## HAMS PREDOMINATE

Although previous radio experience is not necessary our experience proves that "hams" are most adaptable to the work involved. A large percentage of our student body is and has been composed of "hams."

## A REAL OPPORTUNITY

If you are between the ages of 18 and 32, in normal health with no physical defects, Midland training and Airline Radio Operating offer you an unusual opportunity to qualify for steady, well-paid, fascinating jobs in Aviation.



For complete information  
write Norm Souther,  
**AVIATION DIVISION**  
**MIDLAND TELEVISION, Inc.**  
Dept. 30-M, Power & Light Bldg.  
Kansas City, Mo.

directive receiving antennas, noise limiters, audio selectivity — these are some of the subjects to receive attention. The example is an excellent one for amateur groups in all affected countries to follow, we feel.

### *New Zealand*

The executive branch of the N.Z.A.R.T., watching the position of amateur radio very closely, tells us it is still far too early to decide what the future of the association will be. Meanwhile, all activities not affected by the ban will be continued as far as possible. An attempt is being made to keep up publication of the magazine "Break-In", even though reduced in size. The executive is urging all branches to continue their meetings. It was, of course, necessary to cancel all arrangements for the Australia-New Zealand centennial DX contests.

### *Netherlands*

On Wednesday, August 30th, all PA hams received telegrams from the government bureau of communications suspending until further notice "all communications by electric radio sending devices." The N.V.I.R. have made a strong plea to members for strict adherence to the decree since evidently the government has not resorted to the harsh procedure of confiscation of equipment. Recognizing the importance of keeping the organization intact insofar as possible, in order to have a nucleus on which to rebuild after hostilities cease, the society's board has urged all clubs to continue meetings and keep in touch with each other. Here, again, attention is being turned to technical subjects of a receiving and similar nature.

### *Norway*

The blow fell for LA amateurs on September 18th, when the government telegraph service announced that all amateur radio station licenses would be cancelled immediately. An expression of confidence in the ability of amateurs is shown by the government's plan to permit operation of selected stations, under military supervision, in an endeavor to locate illegal transmitters.

### *General*

Following the precedent adopted by both armies in the Spanish civil war, some of the present belligerents, unable to find clear channels in the crowded short-wave spectrum, have been carrying on communications in the now-clear amateur bands. Many of the bulletins which emanated from Warsaw in the opening weeks of the war, some relayed to foreign audiences, were transmitted in the 7-Mc. amateur band. It is not too difficult to realize, then, why governments at war feel they must commandeer all available frequencies regardless of priority or rights of any of its citizens.

Excepting South Africa and Norway, no more close-downs of amateur radio activity have been apparent since our last report. There was a rumor to the effect that Columbian amateurs had re-

# Merry Christmas

SWITCH TO NEWARK FOR PROMPT 4-HOUR SERVICE

## CABINET BARGAIN

Complete with front panel to match **Only \$2**  
 Black crackle finish heavy gauge metal. Hinged top door. 12 1/2" high, 19" wide, 11 1/2" deep. Just right for an FB that model rig or for mobile job. Shipping \$2 wt. 16 lbs. (No. P-1)  
 Chassis to fit this cabinet, 10" x 17" x 3 1/2" **80c**

## JUST OUT

Frank C. Jones' Big New Book **CATHODE MODULATION**  
**\$100**  
 ORDER YOURS NOW

## FREE!

NEWARK'S BIG NEW **84 page Catalog**  
 Thousands of items for the Ham. Sets, parts, accessories, and supplies, fully illustrated and described with lowest prices. Newark's most complete Amateur Radio Catalog.  
**SEND FOR IT TODAY!**

## NEW NOISE LIMITER



**AT NO EXTRA COST**

in your NC100XA, NC101X or NC101XA

Taylor's **NEW TW-150**

Already a "Best Seller" — buy yours from **NEWARK**

**\$15.00**

Newark is Transmitting Tube Headquarters

Always a Complete Stock! **ALL MAKES.**

T-21 ..... \$1.95  
 T-20-TZ-20 ..... 2.25  
 T-40-TZ-40 ..... 3.50  
 T-55 ..... 6.00  
 866 SHIELDED.. 1.50

## NATIONAL

NC101X or NC101XA

**\$2580**

Only Down

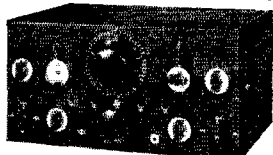

Choice of Direct Reading or Micrometer Dial. **Cash Price..... \$129**

OTHER RECEIVERS AVAILABLE ON OUR FAMOUS 6% TIME PAYMENT PLAN

- ★ Send 20% down payment with your order
- ★ Add 6% carrying charge to the balance
- ★ Divide into 12 monthly payments or less

	Cash Price	Down Payment
NATIONAL NC100XA.....	\$142.50	\$28.50
NC44.....	49.50	*
NC80-81X.....	99.00	19.80
HRO DeLuxe.....	179.70	35.94
RME 70.....	138.60	27.72
691B20 Combination.....	152.88	30.58
181,80.....		36.36
HAMMARLUND HQ120X.....	138.00	27.60
HALLICRAFTERS SN 21.....	81.50	16.30
SN 23.....	127.50	25.50
Sky Buddy.....	29.50	*
Sky Champion.....	49.50	*
Sky Rider S10.....	69.50	13.90
Sky Rider Marine.....	64.50	12.90

\* Indicates sets sold for cash only

## NEW RCA 811-812 \$350 each

Transmitting tubes in stock  
**FULL LINE HYTRON Transmitting Tubes in stock. Order NOW for IMMEDIATE SHIPMENT**

★ **Your CALL LETTERS in GOLD..... 10c** ★  
 ★ Big shadowed decalcomania letters nearly TWO INCHES high. Put them on your HAM SLACK door, auto window, etc. Send dime for yours today. Be sure to give your call letters. ★

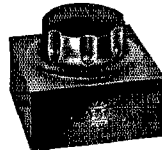

The Ideal Christmas Present

Everybody wants one — just the present for any ham.  
**Only \$3.50**

We also stock the complete **JAMES MILLEN LINE**

# NEWARK Electric Company

323 W. MADISON ST. Dept. Q CHICAGO, ILL.



Down the column we've described Models 801 and 411 — only two of the 30 different models of RCP test equipment series. Compare these instruments for performance, quality, appearance and low cost with any other equipment line. That's where the real test lies — in the value. Here is convincing proof that you get the equivalent of more individual instruments, more ranges — higher and lower ranges — better circuit design — with high quality, accuracy and attractive appearance for less money than you would pay for any other make of equipment. Check us when you check these outstanding testers.

**RCP COMBINATION TUBE and SET TESTER Model 801**

NOWHERE COULD YOU BUY these two essential instruments individually and get the same high quality at the same low price. Tests all new and old tubes and ballast tubes; hot interelement short and leakage tests on each individual element. Noise test. Smooth line regulation 103 to 135 volts — direct meter indication. Model 801 (sensitivity 1000 ohms per volt) provides A.C.—D.C. voltmeter, each 0-10-50-500-1000; D.C. milliammeter 0/1/10/100/1000. D.C. amps 0/10. Also D.B. meter and output meter. 4½ inch D'Arsonval Meter protected by fuse and supply line is double fused. Meter reversing switch — Alnico Magnet meter — 2% accurate; four ohmmeter ranges read from 0.1 ohm to 10 megohms. Compact, light, with slip hinge cover case. Complete with tube, battery and test leads. **\$27.95** Net.....

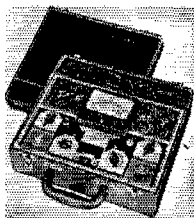

**RCP UNIVERSAL SUPERTESTER Model 411**

THE MOST COMPREHENSIVE tester ever devised to provide measurements of such accuracy in ranges never before available in small instruments. Use it for checking heavy currents, use it for Television work. Features include: 5 each AC-DC voltage ranges read from 0.2 to 5000 volts. 3 high ohmmeter ranges to 4,000,000 ohms — self-contained batteries. Low ohm range center of scale 5 ohms — each of first ten divisions reading 0.1 ohm. In natural hardwood case. 6 D.C. current ranges read from 4 microamps to 25 amperes. 4 A.C. current ranges read from 10 milliamperes to 25 amperes. Net..... **\$16.25**

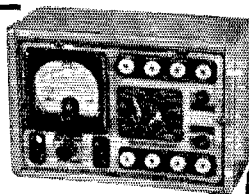

Today! Send for catalog No. 121 describing the complete line of economical RCP test equipment.

**RADIO CITY Products Co.**  
88 PARK PLACE NEW YORK CITY

ceived such orders; but we hear them, as well as nearly all other South American countries, on many occasions. J's, U's and XU's continue to roll in. Occasionally we hear a European non-belligerent, such as OH.

Ken Brink, formerly VE2NT, expresses well the spirit of amateurs in "closed-down" countries in the following manner:

**"Seventy Three"**

From Halifax to Coppermine,  
From Churchill to Quesnel,  
Hams living north of "Forty-nine"  
Must say a sad farewell.

Our little chats must wait a while  
Till Peace once more is nigh —  
And though it's hard, we'll try to smile  
In bidding you good-bye.

Our signals now no longer blend,  
But still our friendship's strong;  
So cheer up, boys, and let's pretend  
That it's a short "so long".

We hams are not the hating sort,  
And till we meet again —  
(For men are men — the race means nought) —  
Let's say, "Auf Wiedersehen".

Oh, how we'll miss that evening rag  
With pals across the line;  
And how the lonely days will drag!  
But now it's time to sign.

So pull the switch and QRT —  
I know it's hard, VE's,  
But sometime soon, I know, we'll be  
Back swapping 73's.  
— Ken Brink VE2NT VE2RR

**Revamping the 30FXB**

(Continued from page 48)

of Packard high-voltage cable to the center tap of the modulation transformer. This supplies unmodulated plate voltage to this stage, metered through the modulation meter. As the plate coil of the doubler stage can be removed, when the high voltage is off, and the static current of the modulators read, it is a simple matter of arithmetic to determine what power this tube is taking. The final amplifier and its grid circuit are metered by their respective instruments. No additional wiring is necessary, nor are any changes made in the Collins diagram or circuits other than the use of the plugs as shown, and the tap to the modulation transformer. There are three other wires necessary and the job is done. These are the primary leads for the filament transformers to terminals 8 and 9 on the Collins power supply, and the cathode return lead which goes to terminal 6 on the same unit. Using this system, the control of the 28- and 56-Mc. unit is identical to that of the original Collins transmitter. And it is only necessary to open the three switches when working on the lower frequencies.

Quite adequate excitation is obtained with the simple loop of high voltage wire clearly shown in the illustration for 28 Mc., so no other link circuit is necessary. However on 56 Mc. a two-turn



# BUY Hallicrafters from Bob Henry, W9ARA

I guarantee you a fair and square deal and to personally cooperate with you to see that you are 100% satisfied.

YOU get prompt shipment in factory sealed carton from the world's most complete stock of amateur equipment. Or shipment from factory if you prefer.

YOU get ten days' free trial — you don't buy unless you are satisfied.

YOU get 6% terms financed by myself so you buy with less cost — more convenience — quicker delivery.

YOU get big trade-in for your equipment — describe it and I will tell you its value — pay the balance on terms if you wish.

So write me fully about your wishes and I will send you full information and will see that you are 100% satisfied. Or send me your order and I will guarantee you can't buy for less or on better terms elsewhere.

Model	Cash Price	Down Payment	12 Monthly Payments
Sky Buddy.....	\$29.50	\$5.90	\$2.08
The New S20R....	49.50	9.90	3.49
SX-24 Defiant....	69.50	13.90	4.90
SX-23.....	115.50	23.10	8.16
SX-17.....	137.50	27.50	9.71
Skyrider 5-10....	69.50	13.90	4.90
S-22 Marine.....	64.50	12.90	4.55
HT-6.....	99.00	19.80	6.99
HT-1.....	195.00	39.00	13.78
HT-4.....	695.00	139.00	49.11

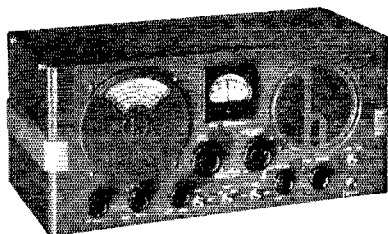

**See it! Operate it! Compare it!**

Prompt shipment of S20R and other receivers on ten day trial.

*Similar Terms on All Other Hallicrafters Receivers and Transmitters*

I have a complete stock of all amateur receivers, transmitters, kits, antennas, tubes, parts, etc. Send to me for anything at the lowest net wholesale price in any catalog or ad. Your inquiries and orders invited.

*Bob Henry*  
W9ARA

**HENRY RADIO SHOP**  
BUTLER, MISSOURI



# Presents

## THIS MONTH'S FEATURE

### U-31 "SEND-'CEIVER"

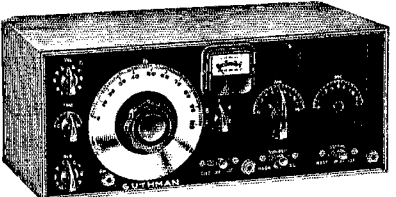

**COMPLETE HAM STATION  
FOR BEGINNERS • PORTABLE • EMERGENCY**

A four-tube Superhet receiver, with controlled regeneration, covering 10-700 meters on six bands—PLUS built-in one tube C.W. Xmitter (10 watts output) with socket and panel space for adding power amplifier and one or two tube modulator. Crystal controlled, 5 thru 160 meters. A.C. power-supply and milli-ammeter included. Size: 17 x 7 x 7. Provision for 6 volt vibrapack use.

U-31 kit, less cabinet, tubes xtals. . . . .	Net \$29.97
U-31 wired (as above) . . . . .	37.47
U-32 cabinet . . . . .	2.97
U-33 amplifier kit . . . . .	3.90
U-34 modulation kit . . . . .	3.60
U-31 tube kit (1 each 6K8, 6SJ7, 6B8, 80, 7C5) . . . . .	3.54
W9PTD . . . . . W9AOB . . . . . W9UVH	

Order from your jobber, or if he is out of stock, order direct, giving jobber's name. Write dept. Q for complete information.

# Guthman

EDWIN I. GUTHMAN & CO., INC.

400 S. PEORIA ST. CHICAGO, U. S. A.

CABLE ADDRESS: GUTHCO-CHICAGO

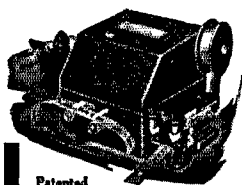

Patented

## AUTOMATIC SENDER

Sends up to 70 words a minute. Motor driven. Entirely automatic. Built-in tape perforator. Absolute uniformity in spacing of characters.

Excellent practice medium for beginners when connected with buzzer or oscillator. Practice tape containing alphabet, numerals, word combinations, etc., together with ample supply of blank tape. Speed up your receiving. Accustom yourself to any speed up to 70 W.P.M. Full operating instructions. No extra equipment needed. If your dealer can't supply, write us.

**FULLY GUARANTEED**

**GARDINER-LEVERING CO.** Haddon Heights, New Jersey, U. S. A.

# The Ideal "HAM" Xmas Gift

### A Perfected

**\$12.50**

\$13.50  
West of  
Denver

Postpaid  
in U. S. A.

link about each coil with an open line is needed to excite the final properly.

One other point bears mentioning, and that is the matter of drilling mycalex. Current practice is to work it under water. However, use a hand drill, turn it slowly and work it dry, and a 1/4-inch hole can be cut in less than five minutes, which is considerably shorter time than it takes for a very much smaller hole when cut under water. The secret is to work very slowly, with not too much pressure on the drill.

There is one final point which must be mentioned. You are dealing with lethal voltages. All the coils are alive when the switches are closed, even though the carrier is not on the air. Turn off the transmitter before making any adjustments other than tuning, and insulate all shafts with insulating couplings as well as knobs. Your budget allows it, and it is best to play safe.

Very gratifying reports have been received from many stations contacted. The new unit certainly has been most satisfactory, and will add many hours of pleasure and enjoyment to the user and well repay him for his trouble in building it. And best of all, no disturbing of the original transmitter was necessary, thus avoiding the introduction of any headaches not really called for. In conclusion I wish to express appreciation to W2KLV and W2LSO for their consideration and careful assistance in checking the signal when the unit was first placed on the air.

## Correspondence

*(Continued from page 55)*

Why our headquarters staff of the American Radio Relay League should lay the blame entirely on the transmitters of the amateurs in every article in *QST* and other publications, never mentioning the real cause of the trouble to any great degree, is beyond my powers of reasoning. . . .

—George H. Freer, W9MWU

**Editor's Note.**—The present regulations specify that the amateur shall be subject to regulation only when he interferes with "receivers of modern design." The F.C.C. recognizes the deficiencies of obsolete or poorly engineered receivers, and does not cite the amateur unless he interferes generally with reasonably good sets.

However, even without regard to the merits of such an argument, it behooves amateurs to keep their skirts as clean of b.o.l. complaints as possible. With a thousand such receivers to every active amateur, the odds are slightly less than favorable.

A.R.R.L. has taken up with R.M.A. the matter of improved receivers. Until recently manufacturers believed, or claimed to believe, that present-day sets were entirely adequate in this respect. At least now they know better.

Box 536, Montgomery, West Va.

**Editor, *QST*:**

The article on cases of amateur interference with broadcast reception which appeared in a recent issue of *QST*, was very interesting. Maybe the boys who are being heckled by the neighbors will be cheered a little to know that we are not the only ones who get the diakens for busting up the "old farm hour."

The following headline appeared in the *Charleston Daily Mail* of August 25th: "Interference ruining reception. Radio fans make complaints on State Police broadcasts." The text follows: "The State Police's new radio station at South Charleston may be a great aid in the apprehension of criminals, but it is likely to be a headache to radio fans in the vicinity, the *Daily Mail* learned Friday. Broadcasting at only 150 kilowatts (sic) for a brief period until the perma-

Write for FREE  
100-page CATALOG

# The RADIO SHACK

BUY ON  
EASY TERMS

MAIL ORDERS  
PROMPTLY FILLED



## MILLEN HETROFIL

Described in September '39  
issue of QST. **\$3.50**  
Net price.....

## BROWNING FREQUENCY MONITOR

Deviation meter visual indica-  
tor. A new circuit — special  
features.

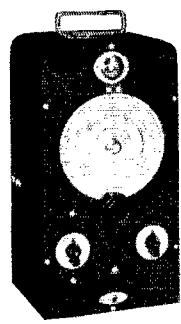

Less tubes — net  
price..... **\$27.45**

Complete set of five matched  
tubes. Net price..... **\$3.36**

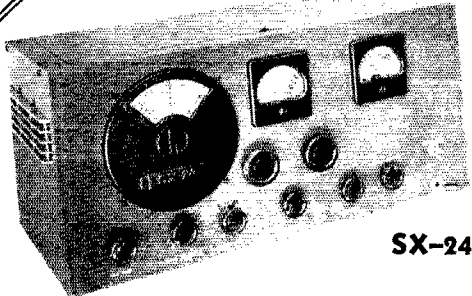

**SX-24**

## HALLICRAFTERS SKYRIDER DEFIANT with FREQUENCY METER TUNING

Including Tubes and Crystal but less Speaker. **\$69.50**  
Speaker \$12.50 extra.....

General Coverage: 43.5 to .54 MC in 4 bands — Built-in  
Noise Limiter — Crystal Filter — Variable Selectivity —  
Frequency Stability — Break in Relay Operation — 9  
TUBES — S Meter calibrated in S units and DB — Main  
Tuning Dial directly calibrated — Electrical Band Spread  
directly calibrated.

### LIBERAL TIME PAYMENT PLAN

Model	Down Payment	Per Month for 12 Months
SX-24.....	\$13.90	\$5.00
SX-24 and speaker.....	16.90	5.90

*In Stock!*

## RCA-811 and RCA-812

(High-mu type)

(Low-mu type)

225 Watts Input.

6.5 to 8 Watts Driving Power.

ICAS Class "C" Telegraphy Ratings.

"Big league"  
tube perform-  
ance at only **\$3.50**  
each  
(Amateur Net)

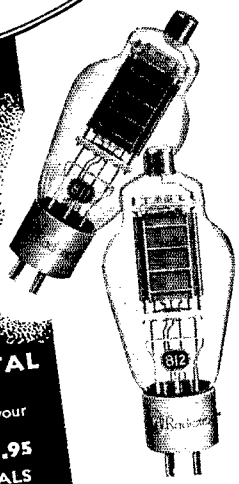

## X-CUT 40-METER MOUNTED CRYSTAL

7000 to 7200 KC

Supplied within 10 KC of your  
desired frequency.

Special Net Price **\$1.95**

## UNMOUNTED CRYSTALS

7000 KC TO 7300 KC

Within 10 KC of your desired  
frequency.

Special Low Price **\$1.35**

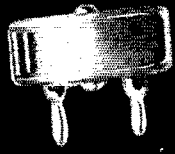

# The RADIO SHACK

167 WASHINGTON ST., BOSTON, MASS., U.S.A.

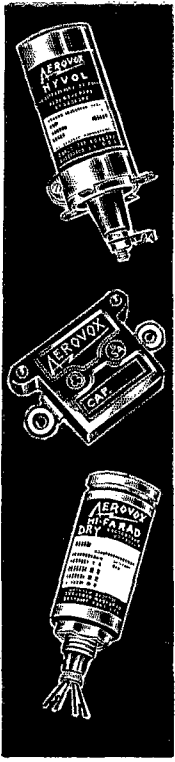

# Somebody knows!

In compiling the new 1939-40 AEROVOX catalog, a lot of thought has been given to current "ham" requirements. You'll find many new items you've been looking for.

The oil-filled paper condenser line, for instance, now includes higher voltages to take care of television and more ambitious circuits.

Molded mica capacitors are now available in the XM or yellow low-loss bakelite.

Many new type electrolytics—tiny metal-can units, inexpensive cardboard case and tubular jobs, etc.

## New CATALOG . . .

By all means ask your supplier for the new AEROVOX catalog. See what's new. Or if you prefer, write direct.



ment station can be completed, the station's calls have already spread themselves over the regular broadcast channels in some localities and on some sets, drowning out more distant stations and confusing the reception of others. There is not much the station can do about it, according to Lieutenant K. C. McGregor, chief of communications for the Department of Public Safety. He pointed out that the station, WPWV, is not operating, as is commonly supposed, on short wave, but on a band slightly above the regular commercial channels. For some obscure technical reason, the broadcast on the band between 1600 and 1720 kilocycles may be easily received in some areas on radios with a range marked only up to 1500 kilocycles. Radio fans may meet the situation in two ways, Lieutenant McGregor explained. They may use only modern sets built within the past two years which are generally sensitive enough to eliminate the state police calls when they are not wanted, or they may install inexpensive wave traps, which eliminate the unwanted calls without interference."

I would have sent you the clipping itself but for one reason. I'm going to have it framed to show to folks who want to know why my rig is "on the broadcast band." . . .  
— J. C. Craver, W3OBZ

### THANKS

12 E. 29th St., Covington, Ky.

Editor, QST:

I noticed in October QST that W4EWK suggested amateurs write and thank Columbia Pictures for the presentation of amateur radio in the picture "Grand Jury Secrets."

Knowing the feeling that exists between film companies, I don't think Columbia would be particularly interested in receiving congratulations on a Paramount picture. Hi!  
— Howard Roubush, W9GZF

EDITOR'S NOTE.— Another current picture with a ham radio angle is Warner Brothers' "Everybody's Hobby."

### PUNCTUATION MARKS IN CODE EXAM.

813 7th St., S.E., Minneapolis, Minn.

Editor, QST:

When I was taking the exam for my license last week, I found that QST was mistaken in saying that only the question mark was used in the code test. True, it was the only one in the receiving tests, but you are also required to send a paragraph in which the period and comma is used. I am of course referring to the new period and comma because every would-be ham must at least know the old ones. Technically, it is enough to flunk on. Incidentally, it might be a good idea for QST to publish them again as I have noticed that they are not coming into use very quickly.

— Don Fraser

EDITOR'S NOTE.— Under the international telegraph regulations as revised at Cairo, 1938, the code symbol for a period was changed to (- - - -) and that for a comma to (- - - -). At present, there is no code equivalent for the exclamation point. Readers about to take the amateur examinations are advised to learn these new symbols to prevent failure on that account.

### LET'S MOVE!

10304 Glory Ave., Tujunga, Calif.

Editor, QST:

I have just read Mr. W. T. Cushing's article in the September issue of QST concerning the reduction of QRM.

With the widespread use of variable frequency exciters fresh in mind, may I make the following suggestions for further reduction of QRM.

For those who like twenty-meter c.w., simply fire up the transmitter on any frequency between 14,000 and 14,150 kilocycles and enjoy yourselves a nice quiet evening so far as QRM is concerned. The concentration of signals in the 14,250 to 14,400 portion of this band is appalling, while those signals now heard from 14,000 to 14,150, if laid end to end, wouldn't consume over forty kilocycles of space. Let's move down!

For those who like forty-meter c.w. may I remind you, as has oft been done before, that this band extends from 7000 clear to 7300 kilocycles, and that there are no blackouts or dead spots for communication anywhere in this range of frequencies. Let's move up!

(Continued on page 116)

**P**iezo-Electric Crystals Exclusively

- Quality crystals of all practical frequencies supplied SINCE 1925. Prices quoted upon receipt of your specifications.

Our Pledge: **QUALITY FIRST**  
**SCIENTIFIC RADIO SERVICE**  
"The Crystal Specialists Since 1925" University Park, Hyattsville, Md.

## READ LIKE AN EXPERT!

Learn Quickly at Home, Get Real Speed

It's easy, fascinating, to become a good op with the NEW ALL ELECTRIC MASTER TELEPLEX CODE TEACHER to help you. Only instrument ever produced which records your sending in visible dots and dashes—then sends back to you at any speed you desire. Also sends practice work, recorded by an expert. That is why so many schools teaching code prefer Master Teleplex.



That is why thousands agree this method is surest, quickest—has taught more ops in the past few years than all other methods. We furnish Complete Course, lend you Master Teleplex, give you personal instruction with a MONEY-BACK GUARANTEE. Low cost. Send today for booklet Q 12; no obligation.

### THE "HAM" SPECIAL

Standard Teleplex—a highly efficient code teacher using heavy specially prepared waxed paper tape, having two rows of perforations. Write for Free folder Q. T. 12.

We are the originators of this type instrument  
**TELEPLEX CO., 67-68 Park Place, N. Y.**  
In Canada, Write  
Canadian Electronic Institute, Toronto, Ontario

# The HANDBOOK

» The 1940 edition of THE RADIO AMATEUR'S HANDBOOK swings out in harmony with the modern tempo of amateur radio. Not only is it rewritten from the top of its head to the tip of its toes, but its whole internal structure has been reorganized to best and most logically present the picture of technical amateur radio. The 1940 HANDBOOK makes all previous HANDBOOKS hopelessly out of date. Each subject is treated topically and then by its component sections. When you want to learn something in particular about transmitters, you will find your problem segregated. Perhaps it will come under "construction" — in which dozens of modern, proved exciters and amplifiers are described in detail — or under "Complete Transmitters," in which rigs complete to the last power connection and microphone plug are shown. Or your transmitter question may refer to one of the other chapters — that on "Principles," or the one on "Adjustment." There are 32 chapters in this new stream-lined HANDBOOK — a complete treatment of practical amateur operating and constructional data. There are two introductory chapters, intended for the newcomer first learning about amateur radio. There are four on Principles and Design — not old-fashioned "theory," but a compact, comprehensive course on 1940 radio fundamentals. There are *fourteen* chapters in the Construction and Adjustment section, ranging from workshop practice through B.C.I. elimination. There are five on antennas, and five more on the Ultra-High Frequencies, with 28 and 56 Mc. in one classification and all above 112 Mc. in another. And finally there are chapters on operating the station and regulations and data. The enlarged index enables the reader to locate easily and quickly the exact references he seeks. The 1940 HANDBOOK is now not only the biggest book of its kind you can buy anywhere in the world for a dollar; it is the whole structure of amateur radio reduced to type and set forth in 576 pages and 830 illustrations.

**\$1 postpaid in Continental U.S.A.**

**\$1.25 postpaid elsewhere**

Buckram bound edition, \$2.50

**American Radio Relay League  
West Hartford, Conn.**

MULTI-ELEMENT DIRECTIVE SYSTEMS • ANTENNA CONSTRUCTION •

TRANSMITTER ADJUSTMENT • KEYING AND B.C.I. ELIMINATION

• STORY OF AMATEUR RADIO • GETTING STARTED • ELECTRICAL AND RADIO

CONSTRUCTION OF RECEIVERS • TUNING AND ADJUSTING RECEIVERS  
PORTABLE • STATION ASSEMBLY • TUBE CHARACTERISTICS AND  
MISCELLANEOUS DATA • ANTENNA FUNDAMENTALS • R.F. TRANSMISSION LINES • LONG-WIRE ANTENNAS  
CONSTRUCTION OF TRANSMITTERS • POWER SUPPLY • MODULATION EQUIPMENT • COMPLETE TRANSMITTERS  
ADJUSTMENT OF PHONE TRANSMITTERS • MEASUREMENTS AND MEASURING EQUIPMENT • EMERGENCY AND  
FUNDAMENTALS • RECEPTION OF RADIO SIGNALS • RADIO TRANSMISSION • MODULATION • WORKSHOP PRACTICE

# Station Activities



## NEW ENGLAND DIVISION

**CONNECTICUT** — SCM, Frederick Ellis, Jr., W1CT1 — Nutmeg Net; 3640 kc. 6:45 p.m. daily except Sunday. The Section starts off in mid-season form, with more activity and much higher traffic totals. AW leads off with a nice 568. KKS pounds plenty of brass. JXP keeps busy with Nutmeg, A.A.R.S. and Hundingers nets. ITI puts out a sweet signal on 3640 kc. KQY did all the work getting the Nutmeggers reopened this fall. BHM released the first issue of the Nutmeg Bulletin for the season. It is a swell job, and all the gang express their thanks. AMQ has a new e.c.o. crystal exciter finished and on the air. BDI hooked some C.Z. traffic for AW to distribute. KYQ reports for the Willimantic gang. MHF is a new ham in Storrs. The Willimantic Radio Club has reorganized for the winter season with JBI as new president. KAK recently visited CLE at Brockton, Mass., and enjoyed several QSO's from Brockton with Willimantic friends. COB of Storrs received his old call back, after being off several years, and expects to open up on 7 Mc. soon. HYU is working 1.75-Mc. 'phone. BCG has new SX24 and has joined the Nutmeg Net. 'TD keeps 6:30-8 p.m., "General Traffic Hour," on Mon., Wed., and Fri. KKS reports for the gang in and around Manchester. BEQ has new P.P. 100TH final Class B modulated with 203's. DJC has new band-switching exciter. KOY is on "2½." LZR uses 6F6 e.c.o. and 6L6. JNJ has new P.P. 6L6 crystal osc. rig. JZB moved to East Hartford and is active in F.T.S. LXX is on 1930-kc. 'phone. LXH rebuilding. GPD has new Vec beam on 28 Mc. HWJ moved to Manchester and is on with a 6L6-807 and 8W3. New officers of Manchester Radio Club: DJC, Pres.; DVO, Vice-Pres.; LMK, Secy.-Treas. IJP has a new Mims rotary for 14 Mc. The New Haven Amateur Radio Ass'n, WIGB, is looking for schedules with other radio clubs. DWP received O.R.S. appointment. The Conn. Brass Pounders Ass'n, WICBA, has room for a few more would-be hams at its code class.

'Traffic: W1AW 568 (WLK 21) KKS 260 JXP 217 ITI 174 KV 162 KQY 133 AMQ 114 JQD 98 CTI 90 KFN 89 BDI 81 KYQ 55 JTD 30 JFN 21 BCG 12 TD 8 APW 6 AFG 11.

**MAINE** — SCM, H. W. Castner, W1LE — Greetings to everyone in the Maine Section. I hope everyone who has given such added and valuable help will read this report. Activity and interest is increasing by leaps and bounds. If all who were approached by the local Legion officers will contact them again, they will explain that the State heads of the Legion stopped the elaborate Legion plan and threw the whole thing back into a local status where it belonged. Col. Eldred was apparently unaware of the strict F.C.C. regs. for amateur and broadcast stations. It is needless for me to tell you that our license will not permit control of our stations implied or direct, and the thing to do is to inform all local relief agencies of our excellent Emergency Corps. Explain that in any emergency or disaster we will be in there working shoulder to shoulder with all agencies for the relief of distress of any kind but, owing to strict radio laws, we will have to operate wholly as a separate unit even to the extent of whether they like it or not. MGR is new Bar Harbor ham. LTY is attending college in Canada. Lots of luck. Dick, LIC, Ellsworth, is new E.C. and O.R.S. HWO is on with completely new outfit. The Kennebec Valley Net is sure a live bunch. DPJ is new member and new QTH is Farmingdale. BOK is on 28 Mc. with 200 watts. APU and the XYL LJS are on 28 Mc. DHD has a new bouncing daughter. Congratulations, Jeff, Hams from Lincoln County attended a meeting of the Northeastern Radio Club in Wiscasset, Oct. 4th. These boys are very active and have a fine club. The Pine Tree Net is in full swing. This is indeed a grand bunch of boys (and girls). Hiya, Flo!! (KOH) Hi. Here are the stations that at present are members, meeting at 7:30 p.m., Monday through Friday, at 3597-ke. spot frequency: CRU, GQ, HSD, IBR, IIE, IJF, INW, IQZ, IST, KCO, KAS, GXY, GOJ, KOH, HSE, KLH, ITH, KVK. 'Trunk "G" is in operation with GOJ as the Maine station. If any of you boys are interested to join the Pine Tree Net, please let us know. We need a good station in Franklin, Piscataquis, Knox and Washington Counties. NR is active

in South Portland getting emergency preparation ready. EEY is on 3671 kc. GKC is doing some fine radio work with the Scouts. I'm ready and waiting for any applications for O.R.S., O.P.S. or E.C. Has anyone in Maine enough apparatus to become an Official Observer? IBR is putting out a strong signal with the revamped rig. JNL is on 14 Mc. You boys in Waterville can accomplish a lot if you get together with HSE. KSL has new rotary on 28 Mc. EWN is taking steps to get more action around Portland in emergency work. WIGP/WIFAP, S.N.C.S., A.A.R.S., writes that the Army Net is well prepared to help in emergency. LIP is new O.P.S. Welcome, Bob. We should get up a "Bob" net. Here are a few: IFF, AFA, EEY, ITH, LIP, KBI, FAP, HGX, LTH, TO, KJV, MGR is working 1.75-Mc. 'phone with LIC. We again ask any of you boys to listen in on 3597 kc. at 7:30 p.m., week-day evenings, and see what a fine state net we have. This net connects with the National Trunks, and traffic is almost certain of delivery. LMQ is working hard to complete W.A.S. on 7 Mc. FBJ says that the boys on the 3.9-Mc. 'Phone Noontime Net are talking it over again. If anyone is interested and will write me, I will give you a complete explanation of the emergency preparation we have in Damariscotta. It is one of the finest set-ups, and includes all organizations and every individual. Better investigate. HWY, new E.C. at Rumford, and IMD are taking steps to fully prepare Rumford for any emergency. I attended a meeting in Portland, Sunday, Oct. 15th, of the A.A.R.S. CFO has a fine outfit. Among those present were IJF, KOU, BTA, GE, FAP and CFO. These boys have a very efficient outfit. They are with us 100%, and my advice to many of you fellows is to write CFO for information on the Army Net. The Maine A.A.R.S. started off the season with very good attendance at drills. CFO has been appointed State Radio Aide, due to the resignation of HMS. KOU is Assistant Radio Aide, and FAP retains the office of State Net Control Station. The following are also appointed as Alternate Control Stations: GVS, LML and EFR. I urge every O.R.S. to read fully the fine suggestions of CFO on page 5 of the O.R.S. bulletin dated Oct. 10, 1939. New appointments: Route Manager: ITH. O.R.S.: LIC, LWG, LIP. O.P.S.: DPJ, DWG, HWY. Emergency Coördinators: ITH, LIC, HWY.

'Traffic: A.R.R.L.: W1GQJ 90 IQZ 23 KMM 14 LRP 16 IE 45 LIC 2 LMQ 41 GXY 6 HSE 19 LWG 11 FBJ 15 CDX 2 INW 55 LML 79. A.A.R.S.: W1BTA 41 CFO 149 EFR 8 FAP 139 GE 45 GVS 99 HSD 13 IST 14 IJF 22 KOU 137 LML 59 LMQ 15 LYT 36.

**EASTERN MASSACHUSETTS** — SCM, Larry Mitchell, W1HIL — Ass't S.C.M.'s: IJY, IGAG, Chief R.M.: IJY, P.A.M.: IGAG, Chief E.C.: IHXE, New O.B.S.: HJD, New E.C.'s: HSR, New Bedford, BMW, Barnstable County, LBY, Plymouth County, LUG, Waltham, New O.O.: IBF, New R.M.: EMG, A.A.R.S.-A.R.R.L. Am pleased to announce that HXE, Paul W. Muller, 15 Lea St., Lawrence, is taking charge of all the E.C. work for this Section. All Emergency Coördinators are asked to cooperate with him. EMG is now State Radio Aide for A.A.R.S. in East Mass., also R.M. for A.R.R.L.-A.A.R.S. FB, Dick, IHI, former State Radio Aide, and R.M., has moved to W. Mass. Thanks and luck, Reg. A RECORD, GANG!! 20 out of 22 O.R.S. reported this month. Thanks, and keep up the good work, fellows. ERH has FB new ant. WV reports good DX on 14 Mc. and worked J8CH for 120th country. KCQ reports MHL, Waltham Club station on 3589 kc. JGQ is working on freq. meter. The Merrimack Valley Club held an outing and wienie roast, Sunday, October 1st, at the Black Rocks Reservation, Salisbury, N. H.; 16 members enjoyed the fun. LALB claims LEU is great rag-chewer. 6NWP and 9LOG are at Harvard. LTC is putting up tower for 4-element beam. SI is now on 28 Mc. HA is on 1.75-Mc. 'phone after 12 years of brass pounding. LWH, AKS, JJY, KCT, JSM, KMQ, IUQ and KZT handled lots of traffic, LWH, JJY and KCT making B.P.L. FB. HIL and XYL had fine time at Boston Hamfest and enjoyed meeting the gang. A fine job by the South Shore and Eastern Mass. Clubs. LNN is rebuilding. The Boston and Maine R. R. is interested in forming an emergency net to be used in case of traffic interruption or failure of telegraph lines. For details please contact R. H. Wickens, W1ZZC, 31 Estes St., Lynn. The Hi-Q Club of Lynn reports election of officers: JFX, Pres.; LWI, V.-P.; BSM, Treas.; BSG, Secy.; JBO, Activities Mgr.; BSG, Chief Op. Club is running a contest on 112 Mc. EGR reports 23 stations active in 1.75-Mc. A.A.R.S. Net. They handled a total of 231 messages this month. JSM has fine coverage with his schedules. KMQ says North

Shore Five Net is now on 28 Mc. Hi. IUQ is new reporter. AAR is active on 112-Mc. mobile. LBY is good traffic man. Let's go, Eastern Mass. — Larry, Bud and Kay.

Traffic: W1LWH 563 AKS 256 JJJ 234 JCK 183 (WLVG 73) KCT 165 JSM 124 KMQ 121 MEU 95 IUQ-KZT 111 EPE 85 AAR 78 LBY 75 BDU 54 HWE 49 AGX 46 EMG 40 (WLVG 50) JFS-KH 35 HA 32 BMW 26 LMO 22 WI 11 BB-KTE 9 JDG 7 LQV 5 IGN-HSA-HIL 4.

WESTERN MASSACHUSETTS — SCM, William J. Barrett, W1JAH — EOB leads the traffic parade this month. Nice work, Vic. Among those from West. Mass. attending the Vermont State A.R.R.L. Convention at Rutland were BVR, EOB, AUN, KIK, JXE and JAH. A fine time was had by all. BIV has been very busy with A.A.R.S. nets. BVR has new Vibroplex to machine-gun his Z-signs with. LDV, new O.R.S., is active in A.A.R.S. and Humdinger nets. MCF worked 25 countries on 14 Mc. AJ enjoyed visiting 2USA. COI put up new 3.9-Mc. antenna. LDF is confining his activities to 28 Mc. LJP is new O.R.S. and A.A.R.S. JUS/3 reports from Wilmington, Del.; he would like to work the gang back home; his activities are on 7 Mc. until 3 p.m., and on 3.5 Mc. from midnight on. HDQ is our only u.h.f. O.P.S. How about some of you ultra-high enthusiasts dropping me a line, or getting in touch with Ed, to get some League appointments and activity rolling on these bands? FNY moved to new QTH. LNF visited AZW, BKJ and JAH.

Traffic: W1EOB 267 BIV 241 IOT 218 BVR 29 (WLVG 135) AZW 125 LDV 126 JAH 93 (WLVG 10) BKJ 97 HNE 55 AJ 35 LNH 29 LUA 23 DCH 9 KJK 1 HDQ 2.

NEW HAMPSHIRE — SCM, Carl B. Evans, W1BFT-DMD — The Coos Radio Club held an election of officers: Pres., AP; Vice-Pres., JXC; Secy.-Treas., LLP. The members of the club are active on 1.8-Mc. 'phone and hold daily round-table QSO's during the noon hour. EWF in Hanover has been working some very good DX; his transmitter runs 1-kw. input to a pair of 35T's!! IDY rebuilt and increased power. MGH is new ham in Portsmouth on 7- and 14-Mc. c.w. and 112-Mc. 'phone. KTY is building P.P. T20 final for his rig. KTV is rebuilding with 35T in the final for 28-Mc. 'phone. Phillips Exeter Academy Radio Society is now on the air regularly with the calls EKG/1 and 2MLM/1 on 1.8-Mc. 'phone. They are planning to organize a New England Prep. School Net. Anyone interested please get in touch with Carl Lindemann, Jr., P. O. Box 627, Exeter, N. H. The New Hampshire A.R.R.L. Net has shifted to 3840 kc. for a trial period. Tentative results point to staying on that frequency for the time being. So look for NHN nightly at 8:30 p.m. on 3840 kc. This shift was necessary due to the QRM encountered on 3600. The M.V.A.R.A. held a hot-dog roast and get-together, XYL's invited, at LBD's camp in Pembroke.

Traffic: W1FFL 177 KIN 164 GMM 40 IDY 37 JDP 31 BFT 27 EAL 26 JBA/1 24 JKH 14.

RHODE ISLAND — SCM, Clayton C. Gordon, W1HRC — The Providence Radio Ass'n affiliated with the Providence Y.M.C.A. as of the first of October, moving its headquarters to the Y.M.C.A. building and changing meeting night from Friday to Tuesday at 8:30 p.m. The Code and Theory classes this year will be on Thursday night and will be in the club room at the Y.M.C.A. The gang at W1AQ acted as host to the A.A.R.S. for a special field day and try-out of emergency equipment, at which time Mrs. Weeden of the Red Cross met with the Army gang and learned about ham radio from GTN and his followers. Chili con carne was served with coffee, rolls and doughnuts. AQ's new a.c. power plant and towers inspected, and a general successful social and business meeting was pulled off under the leadership of CPV and GTN. GTN is on with new power supply and crystal-controlled 500 watts. BOY is new member of A.A.R.S. KRQ visited and worked 2USA. QR is keeping Thursday night schedule with 3FIS. JP has e.c.o. 6SK7-6V6-807 working on 3.5-7-14 Mc. JRY is at Westinghouse Welding School in East Pittsburgh. HCK got married. JNO won an RME DB-20 at Manchester, N. H. Hamfest, which he visited with 2JDE/1. MBM on 14 Mc. has 33 states using 6L6 doubler, 20 watts.

Traffic: W1INU 301 (WLVG 181) CPV 176 LDL 153 GTN 132 KOG 109 INT 100 JNX 95 IEG 76 KYK 71 LAB 48 KIV 37 LWA 31 HRC 21 LQG 19 KKE 18 QR 15 BOY 11 HCW 7.

VERMONT — SCM, Clifton G. Parker, W1KJG — 2nd Annual Vt. Convention was well attended at Rutland — an FB time! DQK has shifted to regular operation at 1950 kc. He has pair of 75T's in final of his 28-Mc. rig. JZF has new signal shifter. KOO has plans under way for

portable generator rig for Northeastern area use in emergencies. JVP shifted osc. line-up to a 6L6 and more bias on the rig. KJG completed new band-shifter with T40 final. LRL, Lt. D. K. Armstrong recently transferred to Ft. Ethan Allen from Ft. Williams, Maine, is operating portable from Essex Jct. KTB visited LRL and KXY. CUN is now in Lyndonville. LZO inspected the World's Fair. KUY is now at Lafayette College, Easton, Pa. KXL has new Hammarlund Pro. GVJ is now at 34 Pine St., Laconia, N. H. KVB/1 is now at Arlington Hgts., Mass. LVI is newcomer to Vt., Gerard T. Aldrich, 7 Orient St., St. Johnsbury — greetings! KJR is now N.C.S.C. Vt. A.A.R.S. I.II, LJZ, KWB, KTB and KJR are now in A.E.C. Many thanks for all the activity reports. Hope they will keep coming in.

Traffic: W1KTB 100 KXY 68 KJG 47 AVP 9 KOO 6 KWB 5.

## ROANOKE DIVISION

NORTH CAROLINA — SCM, W. J. Wortman, W4CYB — AKC leads the State in traffic taking over first place from DLX, who came in second. Our congratulations to ABT for taking top honors in the A.A.R.S. QSO Contest which opened the present A.A.R.S. Season. BBS has a new transmitter with P.P. T-55's on 7 and 3.5 Mc. New QTH's this month for OG, QI and AAK. FKU reports that State College Club station is ready to go shortly. DGV returned his RME to the factory for latest gadgets, and an overhaul. QI visited 2USA. DGU chews fat on 3.9-Mc. 'phone. FLC put up new 8K antenna for 14 Mc. BV has twins, XYL, and new speech equipment all in one home now. DW reports activity confined entirely to work and A.A.R.S. roll call on Mondays. TW is burning up 28 Mc. when she is open. New 7-Mc. A.A.R.S. Net in Fourth C.A. We know of two fellows in N.C. on it. CCO and AKC. Any more? AAU is ready to go on 28 Mc. TJ is on 3.9 Mc. occasionally. ADG has new modulation transformer, and has moved to lower side of 3.9-Mc. band. CAY, a 14-Mc. 'phone man is on 3.9 Mc. for the first time. Greensboro Club has been on a re-organization basis, and is trying to get station license. DSM and EXX are new faces on 3.9 Mc. EYA is working 14 Mc. GHO, new Salisbury ham, is on 1.75 Mc. BIP moved to Raleigh from Franklinton, and now has new XYL. DWO and DOR are back on 1.75 Mc. Thanks for all the reports, fellows — please keep it up, and remember. STAY NEUTRAL WITH KEY AND MIKE.

Traffic: W4AKC 45 DLX 37 CCO 21 GSC 8 BV 6 ANU 5. SOUTH CAROLINA — SCM, Ted Ferguson, W4BQE/ANG — DRE operates regularly on 7074 kc. EPJ is back on the air. CXO says, "If you have any trouble locating him, just drive 60 miles per hour through Rock Hill and you will find him." FFO is on 3946 kc. EXJ was elected president of the Palmetto Amateur Radio Club. Other officers: DQY, V.-Pres.; FMZ, Sec. AFQ made PB O.O. report. EZF is active in the 1.75-Mc. 'Phone Net. Thanks, OM. AUW and FEH worked the following 28-Mc. DX: J2, U9, PJ and PK. CZA keeps busy with A.A.R.S. and T.L. "C." CQU schedules DXF and 1LMQ. FMZ is active in the A.A.R.S. A 3.9-Mc. 'Phone Net has been organized with 4AZT N.C.S. and the following members: AFQ, DX, CXO, MJ and TL. We would like more 3.9-Mc. 'phone fellows in this net. Please contact AZT. We are glad to announce that a radio club has been organized in Greenville with KZ, Pres.; CEL, V.-Pres.; FNS, Secy., and CXS, GIM, FYL, FVF, GBY, DAM, GEN, ETC, RDQ, CGU, EMT, EHL, GCW, EZF, CHD, CSP, DJX, CKW, George Cunningham and D. R. Baird, members. Nice going, fellows, and we hope that the club will grow. 73. — Ted.

Traffic: W4AZT 34 CZA 25 CQU 19 AFQ 12 EXJ 7 EZF 6.

VIRGINIA — SCM, Charles M. Waff, Jr., W3UVA — P.A.M.'s: 3AJJ, 3GWQ, R.M.'s: 3GTS, 3HDQ. The S.C.M. wishes to thank all Virginia amateurs for their support and cooperation during his terms of office. Effective November 10th, 3UVA has appointed 3GWQ to act as S.C.M. until the Section can elect a new one, since from that date on 3UVA will be waiting for a W4 call at the Army Air Corps Training School at Tuscaloosa, Ala. Again, thanks for your help, and cooperate with 3GWQ, as he'll need your support to keep the Section going. HAO is on at all hours on 4-Mc. 'phone. The Fredericksburg Amateur Radio Club is going places. ELN reports one of its operators will be XU8NA soon. FBW's 1 kw. is pushing a hole in the ether. HWJ is a new O.R.S., GAL is building new shack. GBK is training

(Continued on page 100)

Quality above all  
**SOLAR**

**TRANSMITTING CAPACITORS**



**TRANSOIL**-Oil-filled capacitors for permanent filters; superior stability over widest temperature ranges; surge-proof construction; separable mounting bands: "Quality Above All!"

Ask for free No. 10 Catalog; buy from your local Jobber

**SOLAR MFG. CORP.**  
 Bayonne, New Jersey

**HERE'S the MIKE**  
 THAT  
**YOU'VE WANTED**  
 CARRIER 105-D  
 FOR  
**FLEXIBILITY**

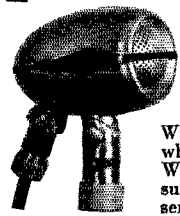

What you put into your mike determines what comes out of the loud speaker. When you use a Carrier 105-D you're sure of crisp brilliancy of the voice. The semi-directional characteristic allows it to be successfully used in places where the acoustical conditions are not the best and can't be controlled. Response of the 105-D Dynamic is predominately flat 40-8,000 cycles per second, output — 65db. and by proper placement of the diaphragm, there is no cavity resonance. Features include: Full frequency response, acoustically correct streamlined design, static and magnetic shielding, inherent ruggedness — long life — and all at a popular price!

**MODEL 105-D, 30 ohms, list \$27.50**  
 200 or 500 ohms or Hi-Impedance, list \$32.50

See it at your Jobber or write for Catalog 10-D giving your Jobber's name and address.

**CARRIER MICROPHONE CO.**  
 439 South La Brea Ave. INGLEWOOD, CALIF.  
 15 East 26th Street, New York, N. Y.

★ **A.R.R.L. QSL BUREAU** ★

For the convenience of its members, the League maintains a QSL-card forwarding system which operates through volunteer "District QSL Managers" in each of the nine United States and five Canadian districts. In order to secure such foreign cards as may be received for you, send your district manager a standard No. 10 stamped envelope. If you have reason to expect a considerable number of cards, put on an extra stamp so that it has a total of six-cents postage. Your own name and address go in the customary place on the face, and your station call should be printed prominently in the upper left-hand corner.

- W1 — J. T. Steiger, W1BGY, 35 Call Street, Willimansett, Mass.
- W2 — H. W. Yahnel, W2SN, Lake Ave., Helmetta, N. J.
- W3 — Maurice Downs, W3WU, 1311 Sheridan St., N. W., Washington, D. C.
- W4 — G. W. Hoke, W4DYB, 328 Mell Ave., N. E., Atlanta, Ga.
- W5 — E. H. Treadaway, W5DKR, 2749 Myrtle St., New Orleans, La.
- W6 — Horace Greer, W6TI, 414 Fairmount Ave., Oakland, Calif.
- W7 — Frank E. Pratt, W7DXZ, 5023 So. Ferry St., Tacoma, Wash.
- W8 — F. W. Allen, W8GER, 324 Richmond Ave., Dayton, Ohio.
- W9 — Alva A. Smith, W9DMA, 238 East Main St., Caledonia, Minn.
- VE1 — L. J. Fader, VE1FQ, 125 Henry St., Halifax, N. S.
- VE2 — C. W. Skarstedt, VE2DR, 236 Elm Ave., Westmount, P. Q.
- VE3 — Bert Knowles, VE3QB, Lanark, Ont.
- VE4 — George Behrends, VE4RO, 186 Oakdean Blvd., St. James, Winnipeg, Manitoba.
- VE5 — H. R. Hough, VE5HR, 1785 First St., Victoria, B. C.
- K4 — F. McCown, K4RJ, Family Court 7, San-turce, Puerto Rico.
- K5 — Norman F. Miller, K5AF, 15th Air Base Squadron, Albrook Field, Canal Zone.
- K6 — James F. Pa, K6LBH, 1416D Lunalilo St., Honolulu, T. H.
- K7 — Jerry McKinley, K7GSC, Box 1533, Juneau, Alaska.
- KA — George L. Rickard, KA1GR, P. O. Box 849, Manila, P. I.

**CIRCULATION STATEMENT**

PUBLISHER'S STATEMENT OF CIRCULATION AS GIVEN TO STANDARD RATE AND DATA SERVICE

This is to certify that the average circulation per issue of QST for the six months' period January 1st to and including June 30, 1939, was as follows:

Copies sold.....	44,814
Copies distributed free.....	402
Total.....	45,216

K. B. Warner, Business Manager  
 D. H. Houghton, Circulation Manager

Subscribed to and sworn before me on this 12th day of September, 1939  
 Alice V. Scanlan, Notary Public



## WITH REMOVABLE STAND-OFF INSULATORS

■ For convenience in mounting on the chassis, the new models of the NC-600U neutralizing condenser and the R-100U and R-300U Chokes are now provided with a small stand-off insulator for chassis mounting. For "pigtail mounting," the insulator may be unscrewed and used for other purposes. Chokes without the insulator are still available, but at a new low price.

Type NC-600U Neutralizing Condenser,  
with insulator. List Price.....**\$.55**

Type R-100U Choke, with insulator.  
List Price.....**\$.60**

Type R-300U Choke, with insulator.  
List Price.....**\$.60**

**NATIONAL COMPANY, INC.**  
Malden, Massachusetts

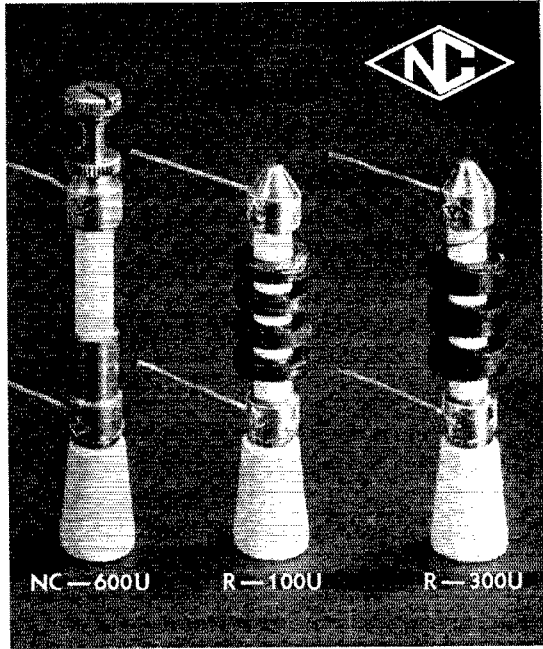

### 110 VOLTS AC **Katolight** Anytime, Anywhere! with **Plants**

Have special plant for operating radio receivers and transmitters. Close voltage regulation. Full 850 watts AC and 100 watts at 6 volts. Filtered and Shielded.

Amateur's price—JRAS, 850 watt **\$66.00**  
Amateur's price—JR55, 550 watt **97.50**

Other sizes up to 10,000 watts.  
Both gasoline and Diesel.

**KATOLIGHT, Mankato, Minn., U.S.A.**

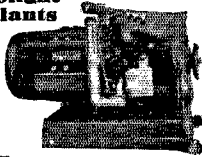

## SICKLES COILS

SECURE A COPY OF OUR NO. 939  
CATALOG FROM YOUR JOBBER

**F. W. SICKLES COMPANY**

300 Main Street

Springfield, Mass.

## ● TELEGRAPHY—TELEVISION—TELEPHONY ●

AVIATION

TRANSRADIO  
PRESS

TELETYPE

TYPEWRITING



PRACTICAL  
EXPERIENCE

STUDIO —  
TRANSMITTER —  
ANNOUNCING

The major technical training equipment owned by Port Arthur College and in operation on the college campus consists of the 500-Watt Commercial Broadcast Transmitter of Station KPAC; two-way Television Transmitter and Receiver; Latest Type RCA Marine and Airways transmitter installation complete; SOS Automatic Alarm; Marine Direction Finder; Trans-radio Press Receiving Equipment; and Laboratory complete where students assemble composite transmitters, amplifiers, audio amplifiers, R. F. amplifiers, etc.

Port Arthur College pioneered the teaching of Radio with classes in 1909, and for thirty years has maintained an active Employment Bureau for the placement of its graduates.

*If interested in details about Radio Course, write for Bulletin R*

**PORT ARTHUR COLLEGE ■ PORT ARTHUR (World-Known Port), TEXAS**

(Continued from page 97)

already for his W.A.S. so watch him. HFL will be back on 1.75-Mc. 'phone. FQP is new Century Club member. Congrats! HBH-IFZ works on 3.5 Mc. during the week, and on 7 Mc. on Sundays. DQB is operator on the S.S. *City of Chattanooga* with a 1-kw. rig to play with, but it won't get down on 7 Mc. I look for DQB on 28- and 56-Mc. operating mobile. KR has an FB e.c.o. and gets TX9 reports consistently. Ex-HOY is now 5IKX at Port Arthur, Tex. GTS is more active now. BSY/4 is quite busy with studies at the Univ. of Fla. FMY reports some DX worked on 14-Mc. 'phone.

Traffic: W3ELN 144 IFZ 98 GTS 67 KR 43 OSY 28 HWT-FMY 2.

WEST VIRGINIA — Acting SCM, C. S. Hoffmann, Jr., W8HD — Congratulations to OXO, my worthy successor. OXO, GBF and BTV have joined Trunk Line "B." HWT accepted responsible position as professor in Naval Training School, CDV taking HWT's former position as Professor of College Electrical Engineering at Linsley Institute, Wheeling. TID, Professor of Zoology, Bethany College, is cataloging prehistoric bones, discovering in excavation near the college. FVU is sponsoring radio course at Y.M.C.A. TGH worked 13 countries with his new 14-Mc. beam. LCN and TOK are on 1.75 Mc. PHV has new 500-watt final. AFX, CXR, KVV and FVU are rebuilding. JRL has new HT-1 transmitter, four antennas and receiver. GBF worked 103rd country. LCN has 87 countries verified. KVV has new receiver. PZT visited Clarksburg, SKD visited 3GTF. DFC joined 3770-ke. Club-O.R.S. Net. JM made W.A.S. TXF is new Dunbar ham. SES's daughter, aged 5, is studying code! Your past S.C.M. wishes to again thank the gang for their past reports, and letters.

Traffic: W8PSR 65 DFC 4 MOL 10 PTJ 191 SKD 4 SUW 8 BTV 40 HD 5.

#### ATLANTIC DIVISION

EASTERN PENNSYLVANIA — SCM, Jerry Mathis, W3BES — 3AKB has resumed regular schedules and is now able to handle traffic in any direction. 3AOC, still in hospital, has his receiver and enjoys eavesdropping on the gang. 3AQN is editor of the "Eastern Penna Dots," an FB sheet for the traffic bound. 3BRZ has made W.A.S. Congrats! We are happy to hear that 3EEW is out of the hospital after a few weeks' stay. 3FPC (PAM) wants more O.P.S. on 1.75 Mc. 3GYK claims success with his 3.5-Mc. top loaded vertical. 3HFE has a 6CUH e.c.o. which operates from 110 a.c. or a storage battery. From Long Island comes 3HQE's report; he was vacationing there. 3HRS is on the Philippine Express Net, and solicits traffic. 3HXA spent many days monitoring bootleggers. 3KJ purchased a pair of big "jugs" and is about to make rough going for the boys on 14-Mc. 'phone. We regret to learn that 3QP will temporarily bow out of the O.R.S. picture. 3RR increased power in preparation for the O.R.S. parties and SS. 8ASW is using two rigs on separate frequencies, no less! 8ATF is feeling out his new QTH. 8SNZ gets up before breakfast for his schedules.

Traffic: W3ADE 18 AKB 132 AQN 140 BES 3 BRZ 2 CHH 3 DGM 2 DXC 7 EDC 74 EEW 10 EFH 22 EML 1600 FXZ 17 GDI 49 GET 1 GHM 3 GJY 45 GKO 383 GYK 12 GYY 14 HBJ 12 HCT 2 HRS 144 HYD 31 HZK 20 IAY 14 QP 470 RR 46 W8ASW 363 ATF 14 OML 16 RHE 13 RKK 9 SNZ 6.

MARYLAND-DELAWARE-DISTRICT OF COLUMBIA — SCM, H. E. Hobbs, W3CIZ — R.M.'s: 3CQS, 3CXL, Chief R.M.: 3BWT. ECP soon will be out of hospital, and expects to be on the air shortly. ICT runs daily schedule with A.A.R.S. Net. HUM has new e.c.o. that works OK. BHE reports W.M.A.R. Club starting the winter season full of pep. GUT has another Jr. opr. HAL says the emergency net on 1888 kc. is working out well, and has enough members to give 24-hour service if necessary. 9PCJ moved from Alton, Ill., to Washington, D. C., where he is 3IHE at 1341 Fairmount St., N. W.

Traffic: W3BWT 658 BKZ 285 CXL 280 (WLM 2898) HUM 251 GYQ 39 CIZ 554 COG 9 ICT 44.

SOUTHERN NEW JERSEY — SCM, Lester H. Allen, W3CCO — Ass't SCM, Ed G. Raser, W3ZI. R.M.'s: 3BYR, 3BEI, 3ZI. P.A.M.: 3GNU. With this writing we bring to a close the calendar year. Highlights: 3AC was National High Scorer in the First Ultra High Frequency Contest. 3PC was Section High Scorer for both 'phone and c.w. in the 11th International DX Contest. 3BZX was high scorer in the Section for the Official Relay Stations, with 3BEI high man for the Official Phone Stations. 3EUH was high scorer in Section for the 160 Meter W.A.S. Contest.

3ZI was appointed Radio Aide by the Army Amateur Radio System for the State of New Jersey. 3EDP is high-ranking member of the DX Century Club. Last but not least, the Delaware Valley Radio Association set new record in the way of attendance in the entire East by states represented at their last outing and hamfest. A vote of thanks and congratulations to these men for their untiring accomplishments in proving that South Jersey has the stuff. Welcome GNM, IIN and ACC to the A.E.C. Supporting Division. AID is new Official Observer. IHO is new O.P.S. HMR joined the ranks of O.R.S., and OQ is the latest O.B.S. Look for HMR on 3700 and 7178 kc. HIC is a new call in Mount Holly. FJW is on 28-Mc. 'phone. ATJ operates on 14 Mc. HAV is building an e.c.o. AFH has a 3-element rotary beam for 28 Mc. MI is busy demonstrating the Emergency Unit for Western Union and lining up Emergency Coördinators and A.E.C. members. FFE is student at Univ. of Penna. IGZ is active on 3.9- and 14-Mc. 'phone. Welcome to South Jersey, Bill. HEO works lots of DX. DEK is working 7-Mc. c.w. and 14-Mc. 'phone. BMB is putting a rig on 1.75-Mc. 'phone. BPH is working 14-Mc. 'phone. BIN has a nice signal on 3.9 Mc. OQ is working three 'phone bands, doing a swell job with his O.B.S., O.P.S. and O.O. appointments. GVM and EBA are operating on 1.75 Mc. DNU keeps daily schedules with 8NDE, and is willing to QSP anywhere. HWO returned to 1.75-Mc. 'phone. GAF will have '03A in final when completed. CFT is quite busy with 7 Mc. FTU is doing FB on 3.9- and 1.75-Mc. 'phone. GRW is experimenting with cathode modulation. CFS has a new receiver, 9-tube super; Steve also reports he is building a rotary beam for 28 and 14 Mc. VE has a new shack. CCC is building an e.c.o. SW is looking for recruits in the Naval Reserve. GLG is using the BX in the house wiring for an antenna on 3.5 Mc. HKO will spend the Christmas Holidays with his family and will then leave for the Northwest, where he will conclude his South Pole lectures; Bud reports carrying portable gear and operating on 3535 and 3700 kcs. A few more O.R.S. and O.P.S. appointees are needed in our Section. Applications or recommendations are urged. Let's not forget the old adage, "There's Volume in Numbers." With this in mind, South Jersey is bound to be on top. Season's Greetings to all — Your S.C.M.

Traffic: W3EFM 128 ZI 116 BZX 110 HDW 71 BYR 70 CFS 52 DNU-HPX 46 IHD 43 EUH 39 FBW 30 GMY 21 EWK 20 GNM 19 BEI-VE 18 CCO 15 GRW 14 GCU 11 AEJ 9 OQ 6 GEV 5 BIC 4 AFH 3 BAY-HLV 2 HMR 1. WLNJ 39 WLNJ 28.

WESTERN NEW YORK — SCM, H. E. Preston, W8CSE — R.M.'s: 8BJO, 8DSS, 8FCG, 8JTT. P.A.M.: 8CGU. E.C.'s: 8GWY, 8RGA, 8RVM, 8SBV. Section O.R.S. Net frequency: 3720 kc. Activity is showing a decided increase. RZF joined the Navy and is stationed at Newport, R. I. SZK will have about 50 watts to the final when rebuilt. GWY attended Vermont State Convention at Rutland. NNJ is consistently active on 3.9-Mc. 'phone and is helping TEP build larger rig for all bands. RVM, rebuilding, will have P.P. T20's in the final. KYM got his Class "A" ticket. QLV is proud papa of a bouncing Junior opr. PWU is new Class 4 Observer. TXB and RTW are getting fine results on 112 Mc. KKE is very interested in 112 Mc. IGT visited WIAW while on his vacation. CP spent a couple hours in a round-table QSO with three other two-letter calls. QGS, DKM and JNU held daily get-togethers at the hospital, when each was presented with a new assistant operator. On October 1st, PLA, FCG, RKM and SBV and their families visited CSE. That made a young hamfest, too. SMI and XYL spent a day with CSE while on their vacation. The Central New York Radio Club of Syracuse has opened its fall season in new club rooms in the Dennison Bldg. on East Fayette Street. The club meets regularly on Thursday nights, and all Central New York hams will find a hearty welcome. KYR is doing a little traffic work again. The employees of the New York Telephone Co. in the Section who operate 3.9-Mc. 'phone have formed an association. At the present it includes ALP, CSE, DSU, IGT, KKN and SED. Weekly meetings are held on the air. Other telephone men are invited to send their names and operating frequencies, either 'phone or c.w., to 8DSU. SBV took in the World's Fair. BJO is N.C.S. of W.N.Y. O.R.S. Net. KDY works from 2 P.M. to midnight, and says not much doing on 1.8-Mc. 'phone during his hours off. CTX broke in on the O.R.S. Net one night. Let's have more reports on local activities. Thanks.

Traffic: W8PWU 15 RVM 11 DHU 5 SZK 2 RKM 69

SBV 54 BJO 94 PJA 118 FCG 281 JQE 195 DSS 19 CSE 63 JTT 49.

**WESTERN PENNSYLVANIA** — SCAM, Kendall Speer, Jr., W8OFO — Ass't SCM in charge of Emergency Coordination, W8AVY. New appointment: R.M.-N.C.R. Liaison, W8QBK. MJK made B.P.L. on deliveries. YA says there is a new gang at Penn. State, and that YA will be going with a new gang of operators. NGJ and YF attended the Jamestown Hamfest. KWA says Batteny, and Hal Bubb of WIAW visited at his home. QAN is alternating schedules with KWA. QBK says they have a new radio code class at Altoona. CKO is nominee for Alternate Director for the Atlantic Division. OKS is using 8 watts with excellent results. DDC is plugging at T.L. "M." RIT is active in the A.A.R.S. SIL, QFM, QFR and NZR left for Pensacola, Fla., for active duty in the N.C.R. IOH is rebuilding. RAU says RBM, HY and GUX have new Skyriider receivers. HKU, BOZ, SVT, TWI, TOJ and JSQ attended the Jamestown Hamfest. OSI moved to 7713 Tuscarora St., Wilkingsburg. NSY will be active with a HQ120X receiver and higher powered transmitter. EYY says the Altoona Horse-shoe Club is going to build a club house. NUG uses a single-wire-fed antenna and e.c.o. HRD has his new 14-Mc. antenna in operation. RYC operates 14236-ke. 'phone. RAT says SWT will be on 28 Mc. as soon as the new steel tower is delivered. QVF uses a Mims 14-Mc. beam. RLS has made over 150 DX contacts on 28 Mc. in the past month with his Mims antenna. says PJJ. KXP worked XUBAI for his W.A.C. RTV got married. Congrats. KNQ wants state auto license tags with ham calls. What say? WILLN is a student at the Pittsburgh Westinghouse Student School.

Traffic: W8YA 240 NCJ 177 MJK 173 KWA 153 QAN 118 DNX 75 QBK 60 CKO 53 OKS 51 MOT 34 DDC 28 NDE 24 OFO 22 RIT 11 CMP 8 RTV 5 SIL 4 IOH-RAU 2 HKU 1.

#### HUDSON DIVISION

**EASTERN NEW YORK** — SCM, Robert E. Haight. W2LU — LSD keeps twice weekly schedules with 250 F.T.S. stations. KWG reports nice traffic work from West Point. LU on 3530 kc. wants contacts with E.N.Y. members. LEI is operating from Altamont and Albany. KXF joined A.E.C. and took over T.L. "G" in place of GTW. MHV, new O.R.S., sports new Sky Buddy. FQG schedules our good friend HOA daily. HNH is off to Long Island to school; sorry to have him leave E.N.Y. BEW and YF attended Hudson Div. Convention. DVC on 3907-ke. 'phone is a 100% rag-chewer. ALP schedules 5HGC and 6USA on 28 Mc. LLU keeps Feura Bush hot; schedules 1MBM and 3FDF. JZG is Sec. R.P.L. Radio Club. SZ is open to any traffic available. Congrats to 2KW; he walked away with transmitter as 1st prize at Hudson Div. Convention; also the code contest. 2DC got second prize, the receiver. Our "Well Done" to 2KUD, 2AMM and the Committee for the swell convention they put over. EWD operates on 7- and 14-Mc. c.w., not on 2½ meters as stated in Oct. QST. LOR, our new O.R.S., is welcomed. As your S.C.M. I extend to all members of E.N.Y. my best wishes for the Holiday Season.

Traffic: W2LSD 168 KWG 86 LU 58 LEI 29 KXF 25 MHV 20 FQG 7 HNH 4 BEW 2.

**NEW YORK CITY AND LONG ISLAND** — SCM, E. L. Baunach. W2AZV — LID and LGK are now O.R.S. We are getting close to the fifty mark in O.R.S., but we want one hundred O.R.S. in the Section. This Section covers the greatest city in the world, and we have the lowest amount of activity for the number of stations that are licensed here. The county of Manhattan does not have an Emergency Coordinator, and very few members in the A.E.C. Anyone who is interested in applying for E.C. for Manhattan, and thinks he can do a good job, should get in touch with 2DBQ. The Section Net operates every night at 8:30 p.m. E.S.T. on 3710 kc. All stations are invited to join in, either for a rag-chew or to move some traffic. MKX of the 18th Infantry at Fort Hamilton is going to Fort Benning, Ga., and is looking for any stations that will schedule him for traffic to Fort Hamilton. EC of the A.P. Trunk Line is looking for an alternate station to hold schedules. Please get in touch with him if you can operate on 3630 kc. CHK is now N.C.S. of the southern N.Y. A.A.R.S. 'Phone Net, and is looking for more stations to join the net. Write CHK for full information. AFU and AXZ are members of HMJ's 7-Mc. A.A.R.S. Net. SC keeps his total above the five hundred mark. The stork brought BGV his first Jr. op. on Aug. 26th. In absence of real DX on 14 Mc., BGV, KYX, KQI, IFK, GMW and LEE get together on Mon., Wed. and Fri. at 11 p.m., and have a

round table, calling themselves the "Wackey Owls Club." KI is on daily at 5:45 p.m. on 3674 kc. KJY is back in Brooklyn after a trailer trip through the West, and what ideas he has on antennas from the West Coast gang! PF has his 30FX for sale. LOQ is at new QTH: 315 W. 19th St., N. Y. C. LBI received Class A ticket. EXR did some nice work helping the "Bronx Revolver and Rifle Ass'n and a N. H. club" to organize a rifle match. IYR is operating from Syracuse on 7171 kc. ELK is on with a complete new outfit. IXQ is using cathode modulation on a T740. LPJ is replacing his 6L6 final with an 809. New officers of the Queens Radio Amateurs: Pres., LPJ; Vice-Pres.-Treas., KFW; Secy., GXC. The Seventy-Three Club has resumed its winter meetings. Anyone desiring to attend should write CWP for information. IXQ has formed a new club in Brooklyn, called the Midwood Radio Club. HGO is spending most of his time experimenting on his 56-Mc. transmitter. The Suffolk Amateur Radio Club began its winter activities with a meeting at Riverhead on Oct. 26th. BFA, DOG, KOA, LEB, LYB and LVN of the eastern end of L. I. are all active on 1.7-Mc. 'phone. IOP is completely rebuilding his rig to use 100TH's in the final. CWP is on 7-Mc. c.w. and 28-Mc. 'phone. DOG is rebuilding his audio amplifier to use 2A3. LZK can take any traffic for the West. APAI, BVE and HHW are going in for HK24's. HBO is on the TuBoro R.C. Net every Sunday at 11 a.m. LG is pounding brass on a tanker. LGK is installing P.P. '45's in the final. The Section Net is very much in need of stations in Manhattan and the Bronx for outlet traffic. AHG has again changed QTH. A new club has been organized in N. Y. C. — the Metropolitan Amateur Radio Society. An accessible meeting place has been secured. A 150-watt 'phone transmitter will be put into use. Many activities are planned. Those interested in membership or further information should contact the secretary, B. N. Gensler, W2LNI, 573 Chester St., Brooklyn.

Traffic: W2SC 548 LZK 358 LPJ 351 ITX 202 (WLNW 167) LR 123 HAIJ 194 KI 119 DBQ 116 (WLNB 134) ANZ 99 PF 98 AZV 70 GDF 40 AEU 37 IOP 35 LGK 29 ENR-JCA 24 EC 17 AA 15 LBI 14 CHK 13 CIT 12 CWP 11 DHK 10 ADW 9 AZM 8 BYL 7 GRJ-KYV 6 MKX 8 CET-DMM 5 DOG-CEN 4 AHG-LID-FLD 3 HYL-HBO-HGO 2 HVC (WLNX 48).

**NORTHERN NEW JERSEY** — SCM, Joseph P. Jessup, W2GVZ — R.M.'s: 2BCX, 2BZJ, 2CGG, 2GVZ. P.A.M.: 2HNP. Section Net frequency: 3630 kc. New appointments: R.M.: RZJ; E.C. HNT; O.R.S. LXI; O.B.S. EKV. HEY took over T.L. "L" job with BCX as alternate on 3615 kc. The Bloomfield Radio Club has reorganized and is building a ½-kw. rig for 3.5-Mc. c.w. and 3.9-Mc. 'phone and a low-power job for 1.75 Mc. 'phone. LAM and LXI joined the Section Net. DYO and IYQ hanker to become O.R.S. JDC made first report, with 606 total handled in F.T.S. on 7 Mc.; he won a bug, too. That's what MIGHT be called a fair beginning. Seven traffic reports came in too late for last month's report. I have to get them at the latest by the 19th. Please give. EKV gave up 14-Mc. 'phone for 1.75 Mc. DZY, the old spark addict, is back and building a bigger combined station with EKV. JRU is fixing to go multi-rig with separate exhalers on 7 and on 14-28 Mc. IQM moved down the street, and will be on soon. BZJ is doing an excellent job with A.E.C. planning for the shore area in Monmouth and part of Ocean County. The gang down there really means business. New officers for Jersey Shore Amateur Radio Ass'n: AIW, Pres.; FQK, V.-P.; LMB, Sec.; AER, Treas. Total A.E.C. registrations for the whole Section are up to 90, including 20 emergency-powered, but that is only a fraction of what we should have. I have lots of lonely application blanks looking for an owner. Can do? LAO is joining the Navy. 5GUR/2 at Ft. Monmouth is a DXer. KIF moved across town. JT is still figuring out which is which on his 100-ke. bar. EQS is Sec. of The L/C Club in Jersey City. DYO and IYQ are new O.R.S. SN has received a mess of cards from Messarabia. Better send him your return envelopes. KNQ left the fold and became 3IZZ. AMF has new putter-outer on 28 Mc. MW suffers from skywiritis, or antenna debility. DVU moved to Saddle River and put up a rotary. JDC is new O.B.S. 2MLM/1 at Exeter wants 1.8-Mc. schedule with a Bergen County station. ABS is building new skyhook. LAG has the rebuilding itch. So has JUU. MKV was new receiver.

Traffic: W2BCX 258 (WLNF 225) GVZ 220 (WLNI 6) CGG 182 LMN 154 HCO 131 JDC 105 LXI 112 HQL 45 (WLNR 54) LAC 23 HHY 22 KHA 19 JUU 18 BZJ 7 JRU 3 DVU-KMI-CMO 2 MEO 1. (Aug.-Sept.: W2JDC 606 CGG 169 JKG 32 HDJ 10 ISF 6 CIZ 3.

# GROSS Radiophone & CW Transmitter

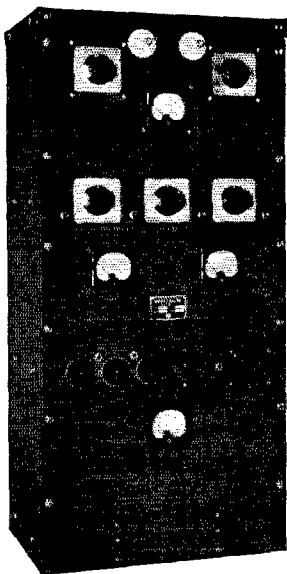

## Gross CB-150

Input — 150 watts

Coils available for 30,  
14, 7, 3.5, and  
1.7 mc

Class B modulation

All the very latest  
type tubes used  
throughout

Completely self con-  
tained from mike  
jack to antenna tun-  
ing unit

•  
Descriptive Bulletins  
on Request

## GROSS RADIO, INC.

51 Vesey Street

New York

Cable Address: GROSSINC

# RADIO OPS WANTED!

In recent months the newspapers have run many articles about the Navy, Coast Guard and the Army looking for trained radio operators. It is a very interesting career for the expert radioman!

You can qualify for your commercial license and a good rating by taking CANDLER TRAINING in your own home as thousands of code operators have done in the last twenty-five years. You will get the same personal cooperation from Walter Candler as McElroy and McDonald, the WORLD'S CHAMPIONS, received!



The New BOOK OF FACTS gives you the story of the champions and many inside tips that will help you. It is FREE, a postal will bring it to you. No obligation.

# CANDLER SYSTEM

DEPT. Q-12

ASHEVILLE, N. C.

## 1939 Field Day

(Continued from page 48)

conditions were perfect, reception was very clear and there was plenty of action from Field Day stations on all bands. 7 Mc. was jammed with "FD" from morning 'til night. Members of the club that do not hold ham licenses did a very good job of helping build the Field Day shack and the operating tables, and helped in a million other ways. — *New Haven Amateur Radio Association, W1GB/1.*

A schedule was drawn up with two operators operating the rig for 2½ hours, while two others had to watch the motor (about 75 feet away) and keep the voltage constant. We had a swell time all night lying around a giant campfire, roasting spuds and toasting bread, trying to keep warm. No sleep was enjoyed by all. Hi. The highlight of the contest was working the Headquarters gang at W1EH, Sunday morning. — *West Side Radio Club, VE3JJ.*

The site selected was a pasture on a farm near Waltz, Mich., and a wooded grove, in the midst of which the four tents were set up, provided the necessary supports for the antennae. Power was entirely supplied by a 1200-watt, 110-volt a.c. generator belt-driven from the rear wheel of a Ford "A"; this arrangement functioned perfectly for 26 consecutive hours, running up some 700 miles on the speedometer. Each of the tents sheltered a complete station on 14, 7, 3.5 and 1.75 Mc. — *Motor City Radio Club, W8MRM/8.*

My first Field Day. Was one hour from home base to complete portable installation and on air. — *W5DAQ/6.*

Location: A summer resort called "Spring Bank Park" some 12 miles northeast of Sparta, Wis. A four-room cottage was rented and equipment installed therein. A small lake nearby furnished amusement for all. — *W9WGP/9.*

The location was a Dutch windmill about 80 feet high. All of the equipment was on the fifth floor which was about 50 feet high. As two other groups from Des Moines were in the field, local competition was pretty strong. It was great sport and we enjoyed every minute of it. — *W9YAW/9.*

We worked thirty states and all districts during the 25 hours, 24 minutes we were on. — *Topeka Amateur Radio Operators, W9GRA/9.*

This year found us on City Hall Tower (by special permission of Mayor Wilson) with completely portable equipment and plenty of antenna problems. The wind velocity built up a static charge of electricity over the surface of this great bronze dome that could be heard, felt and seen. By putting the knuckles of your hand to the protective screening, arcs could be drawn and a neon bulb could be lighted to a fair degree of brilliancy. The whole tower was crackling and receiving was out of the question. The noise it created in the receivers resembled vibrator hash. After we had spent some time inspecting these conditions an electric storm of severe proportions made it necessary to move all the equipment inside the tower and, with limited space, we found our quarters quite cramped. Not being bad enough off, as it were, a bolt of lightning struck the tower just below where we were huddled. Try to imagine being inside a large boiler when it was struck by an express train. The crash resounded down through the hollow tower while our members rang the bell for the elevator with more than violent enthusiasm. Oddly enough, these incidents add to our determination each year to take part the following year better prepared to meet such conditions. — *Ultra-High Frequency Club of Philadelphia, W3EK/5.*

If one field day can be better than another, this one was it! — *W9AB/9.*

Low score is accounted for as follows: Trouble was experienced with one rig, antennas had not much of a chance, and receiving conditions on Sunday hopeless. However, the grand old ham and picnic spirit prevailed, and the low score didn't affect the air of the camp. About a dozen of the gang helped make camp and set up the rigs, while the following day brought some 100 visiting hams. We had noble support from the wives and YL's on the "eats" end of the affair. Well prepared were we, even down to fit guns for the mosquitoes and oil for the red bugs. But all in all, it was a bang-up affair and every one of us look forward to another swell outing on Field Day of 1940. — *Galveston Amateur Radio Club, W5DIG/5.*

This was the club's first participation in the Field Day, but certainly not the last. The location was about two miles east of Port Jefferson, Long Island, at one of the Island's highest points. A good view of RCA's Rocky Point Towers is afforded. The two rigs each used a single 6L6 as an oscil-

Circular A-7 describes the complete line of Bliley Crystal Units and contains a useful amateur frequency chart. Ask your Bliley distributor for your free copy.

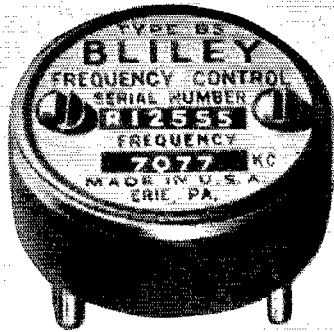

**PRECISION  
MADE  
DEPENDABLE  
ACCURATE  
ACTIVE**

## BLILEY B5 40-METER CRYSTAL UNIT



**PUT  
YOUR PICTURES  
ON YOUR QSL'S ! !**

Send me a good picture of yourself. Snapshot will do, but a good portrait from a real photographer is best. I'll make as many of these little pictures as you wish, not less than 50, and they'll be gummed, ready to stick on like stamps. They're 2c each, and genuine photographs. Send for samples.

EVERYONE KNOWS WHAT YOU SOUND LIKE; LET THEM SEE WHAT YOU LOOK LIKE. THEY'LL LIKE IT. AND SO WILL YOU.

**THE HAM PICTURE MAN**

52 Robert Street

Pawtucket, R. I.



## DYNAMOTORS

From the  
**SMALLEST**  
of them all  
to the  
**LARGEST**  
required

Write Today for Data

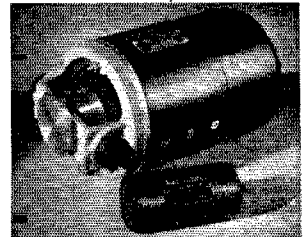

**EICOR INC.**

513 S. LAFLIN STREET  
CHICAGO U. S. A.

## A GOOD NAME GOES A LONG WAY

Ken-Rad Radio Tubes are used by many radio manufacturers as original equipment because they are thoroughly dependable.



# Ken-Rad Radio Tubes

**KEN-RAD TUBE & LAMP CORPORATION - OWENSBORO, KY.**

Manufacturers of all types of radio tubes and Ken-Rad Electric Lamp Bulbs

The **RADIO SHACK** presents

# BROWNING COMPONENTS FOR

## Frequency Modulation

RECEPTION



- ★ FREQUENCY MODULATION
- ★ NOISELESS RECEPTION
- ★ HIGH FIDELITY
- ★ DYNAMIC AUDIO RANGE

Important components for building receivers for receiving Major Armstrong's Frequency Modulation type of transmissions NOW AVAILABLE.

3 Mc. IF and Detection Transformers with band widths of 200 Kc. for High-Quality noiseless reception.

3 Mc. Interstage Transformers — BL-3M — Amateur Net Price \$1.20

3 Mc. Detection Transformers — BL-3D — Amateur Net Price 3.75

3 Mc. IF Amplifier consisting of the mixer stage, two IF stages, limiter, detection system, and output volume control with a-c. switch built on 10 1/2" x 9 1/2" chassis with all holes punched for RF tuner, power supply and push-pull audio power amplifier. If amplifier wired and carefully aligned. Type BL-3.000A — Amateur Net Price \$24.90

High Frequency RF Tuner, wired, and aligned. Consists of a tuned antenna circuit, one stage of radio frequency amplification, and an oscillator circuit. Frequency range from approximately 40 to 54 Mc. Type BL-40T — Amateur Net Price \$11.70

4" Sun-Ray finish, nickel silvered, vernier drive dial for Tuner — Type BL-40V — Amateur Net Price \$2.10

The Yankee Network Frequency Modulated Station, W1XOJ, is transmitting on a frequency of 43 Mc. From Meriden, Conn. W1XPW is transmitting CBS programs on 43.4 Mc. These programs may be received with ample signal strength in most parts of New England.

WRITE FOR COMPLETE INFORMATION

# RADIO SHACK

167 WASHINGTON ST., BOSTON, MASS., U.S.A.

lator, with about 17 watts input. A pair of SW-3's took care of receiving, with "B" Battery plate supply. For the transmitters we had four husky genemotors, two vibrapacks, and four rented storage batteries. — *Sunrise Radio Club, W2SV/3.*

The *Mauai Amateur Radio Club* operated portable from summit of Haleakala, 10,032 ft. above sea level. — *K6FAZ/K6.*

We had the good fortune to have two rigs from the *Chicago Radio Traffic Ass'n* in the same cow pasture (W9VS and W9ANR) and, needless to say, a good time was had by all. We've inspired the 17 year locusts to lustier brand of QRM. W9VS reported trouble from locusts and spiders in neutralizing and plate condensers. It will be a screened outfit next year! We think we learned a lot about portable operation, and we're looking forward already to 1940's F.D. — *Freeport Amateur Radio Club, W9YD/9.*

## Field Day Participants

Club Station	QSOs	Score*
W9AIU/9	Egyptian Radio Club <sup>1</sup> .....	438-AB-9 5508
W2AER/2	Jersey Shore Amateur Radio Assn. <sup>2</sup> .....	313-A-7 4437
W1JHT/1	Bridgeport Amateur Radio Assn. <sup>3</sup>	283-A-5 4338
W3BES/3	Frankford Radio Club <sup>4</sup> .....	301-A-3 4214
W9TGB/9	York Radio Club <sup>5</sup> .....	282-A-5 4194
W9RBI/9	Dells Region Radio Club <sup>6</sup> .....	328-A-5 3942
W2GW/3	Tri-County Radio Assn., Inc. <sup>7</sup> .....	245-A-6 3762
W8ODJ/8	Buckeye Short Wave Radio Assn. <sup>8</sup> .....	295-A-6 3636
W8MRM/8	Motor City Radio Club <sup>9</sup> .....	261-AB 3312
W3GKI/2	Tri States Radio Club <sup>10</sup> .....	257-A-7 3078
W8ICS/8	South Cleveland Radio Club <sup>11</sup> .....	212-A-4 3024
W2OQ/2	Northern Nassau Wireless Assn. <sup>12</sup>	201-A-3 2907
VE3KM	Hamilton Amateur Radio Club <sup>13</sup>	184-A-4 2835
W2ACB/2	Schenectady Amateur Radio Assn. <sup>14</sup> .....	199-AC-4 2833
W9LIP/9	Northwest Amateur Radio Club <sup>15</sup> .....	171-A-5 2701
W9LTC/9	Austin Radio Club <sup>16</sup> .....	178-A-2 2684
W9YWX/9	Sheboygan Radio Amateur's Club <sup>17</sup> .....	183-A-4 2655
W3AIR/3	Trenton Radio Society <sup>18</sup> .....	163-A-3 2520
W3ATR/3	Beacon Radio Amateurs <sup>19</sup> .....	155-A-3 2421
W2AVS/2	Suffolk County Amateur Radio Club <sup>20</sup> .....	159-A 2358
W9KYC/9	St. Paul Radio Club <sup>21</sup> .....	178-A-4 2340
W8NWH/8	K.B.T. Radio Club <sup>22</sup> .....	138-A-3 2205
W3DGM/3	Chester Radio Club <sup>23</sup> .....	151-A-2 2151
W8CHE/8	Steubenville Amateur Transmitter's Assn. <sup>24</sup> .....	144-A-4 2079
W3GAG/3	Philadelphia Wireless Assn. <sup>25</sup> .....	132-A-3 1993
W3QV/3	York Road Radio Club <sup>26</sup> .....	123-A-3 1935
W9PRM/9	Wisconsin Valley Radio Assn., Inc. <sup>27</sup> .....	146-A-2 1899
W1DMD/1	Merrimack Valley Amateur Radio Assn. <sup>28</sup> .....	135-A-4 1872 t
W4NC/4	Winston-Salem Amateur Radio Club, Inc. <sup>29</sup> .....	166-B-2 1782
W8AIR/8	Westlake Amateur Radio Assn. <sup>30</sup>	131-A-2 1776 t
W6NAT/6	United Radio Amateur Club <sup>31</sup> .....	154-A-4 1683
W8GWP/8	Utica Amateur Radio Club <sup>32</sup> .....	121-A-1 1683
W8JKN/8	Mountaineer Amateur Radio Assn. <sup>33</sup> .....	107-A-4 1650
W6BGY/6	Society of Amateur Radio Operators, Inc. <sup>34</sup> .....	155-AB-5 1641
W1DJC/1	Manchester Radio Club <sup>35</sup> .....	101-A-2 1638
W5HCA/5	The Kilocycle Club <sup>36</sup> .....	86-AC-3 1630

\* The "power classification" used in computing the score is indicated by A, B, or C after the number of QSOs shown. A indicates power up to and including 20 watts (multiplier of 3); B indicates power over 20 up to and including 60 watts (multiplier of 2); C indicates over 60 watts (multiplier of 1). More than one letter means that at different times power inputs fell within different classifications. An R or T after the score indicates that receiver or transmitter were supplied from the public mains; no indication after scores where work was entirely independent of mains. r or t is used where only part of operation used mains supply. The numeral following the letters A, B, C, etc., indicates the number of complete units (transmitter plus receiver) in operation.

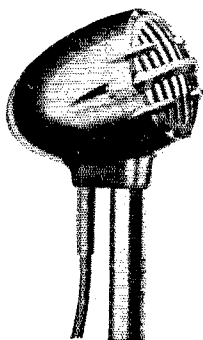

Model JT-30  
Crystal  
Microphone

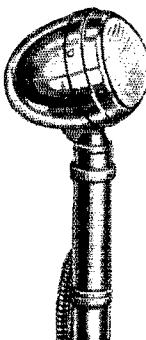

Model T-3  
Crystal  
Microphone

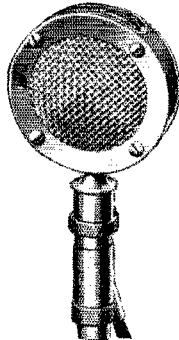

Famous D-104  
Crystal  
Microphone

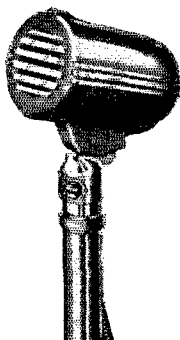

Model DN-50  
Dynamic  
Microphone

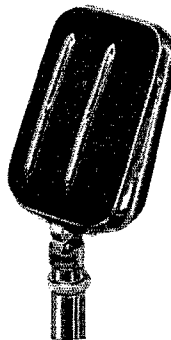

Multi-Unit  
Crystal  
Microphone

## SUGGESTIONS FOR THE HAPPY AMATEUR

*Who Will Soon Have Christmas Money to Spend*

How could you spend "that money given you for Christmas" to better advantage than for an Astatic Microphone . . . in any one of the many attractive, efficient models available?

Astatic Microphones are of the highest type, made from the finest materials available, sturdy in construction, flexible in their use, attractive in design and highly efficient in service.

SEE YOUR ASTATIC  
JOBBER OR WRITE  
FOR CATALOG NO. 12



ASTATIC MICROPHONE  
LABORATORY, INC.  
YOUNGSTOWN, OHIO

*Crystal Products Licensed Under Brush Development Co. Patents. Astatic Patents Pending.*

### RADIO COURSES

*New Classes Start in January*

- RADIO OPERATING • BROADCASTING • CODE
- RADIO SERVICING • TELEVISION
- ELECTRONICS — 1 year day course; 2 years eve.

*Day and Evening Classes — Booklet upon request*

**NEW YORK YMCA SCHOOLS**

4 West 63rd Street, New York City

### The 1940 Type HFM Transmitter

Amateurs, expeditions and others in many countries find the Types HFM ready to deliver whenever needed. Special attention to details and the use of impregnated or oversized parts make these the outstanding jobs for dependability.

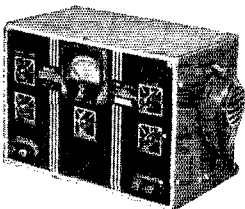

- Six bands with two crystals
- 36 watts r.f. amplifier
- Instantly changeable 6 or 110 v.

Net to amateurs... \$57.60

*Write for bulletins listing complete new line*

**RADIO TRANSCIVER LABORATORIES**

8627 115 Street Richmond Hill, New York City  
Cable Address: "Ratrolab"

### LEARN RADIO • TELEVISION

60-page catalog on request. Oldest, largest and best equipped in New England. Write for new catalog.

**MASS. RADIO SCHOOL**

18 Boylston Street

Boston, Mass.

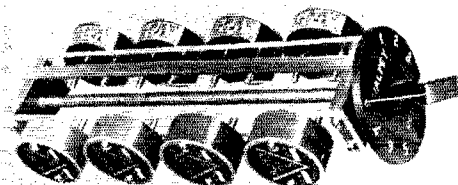

**INSTANTLY**

one to eight frequencies with the

## NEW VALPEY

Type CSI crystal selector, from one to eight crystals can be plugged in the same as in a tube socket.

Contact is made one at a time by eight positions numbered on the dial plate.

All eight crystals are ready for immediate use by a turn of the knob on the panel and while not in use are completely cut out of the circuit at the same time away from the danger of rolling off the chassis onto the floor.

Two wires connect the unit to the oscillator circuit, this not only simplifies wiring but reduces losses.

Only three holes need to be drilled for mounting which is easier than mounting one tube socket.

The type CSI crystal selector is chrome plated brass with polystyrene insulation.

The cost of this unit is less than eight good sockets and a switch.

*Net price, selector only, \$4.95*

**THE VALPEY CRYSTALS**

Box 321, Holliston, Mass.





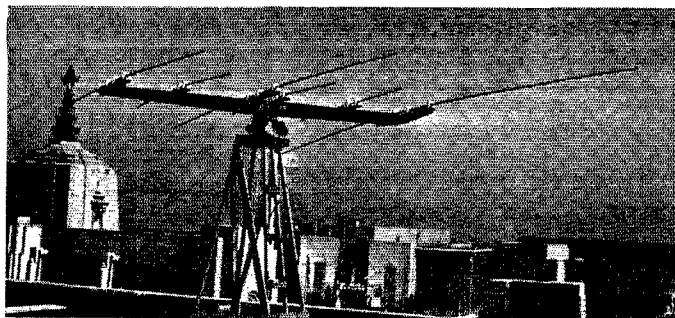

(Photo by W6ONQ)

W6USA's DeLuxe Dual Three — Golden Gate Exposition

# MIMS NEWS

Dear OM:

W6USA is probably the most modern and outstanding amateur transmitter ever built. It was most fitting that the DeLuxe Dual Three be selected for the radiator to be used with it. A combination of the two has produced a signal of the best.

Quoting their idea of it — "To say we are pleased is putting it mildly." Need any more be said?

An even greater advantage is there for the user of lower power for the multiplying power factor quickly lifts him well up. Doubling your transmitter power increases your signal by  $\frac{1}{2}$  R. The DeLuxe Three Elements Mims Beams give you about six times this increase and, better still, in the direction you want to use when you want it there.

Can you afford to do without one?

73,  
M. P. MIMS, W5BDB

See Your Parts Distributor

**MIMS RADIO CO.**  
**SIGNAL SQUIRTER**  
PRODUCTS  
TEXARKANA ARK. TEX.



Join  
American Red Cross

Now **CHOOSE** the Sound You Want  
**TURNER Model 44X CRYSTAL**

- Selective Directional
- Changeable 25 Ft. Cable Set and Full Tilting Head
- Moisture Proof Crystal
- Blast Proof
- Automatic Barometric Compensation
- Mechanical Shock Proof

**CHOOSE** the sound you want to amplify! 44X has 13-15 DB differential between front and rear pick-up, so can be considered dead at back. Reduces feedback. High level -58DB with 25-ft. cable lines. Range 30-10,000 cycles. Satin chrome finish.

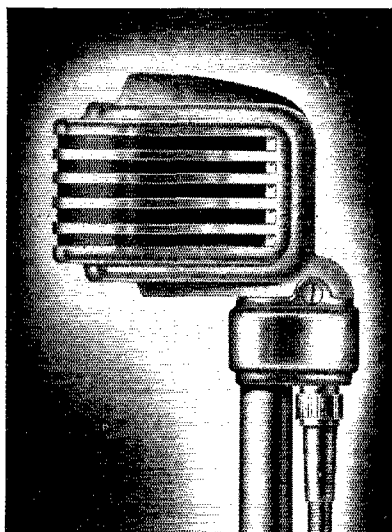

Complete, with 25-ft. Changeable Cable Set.

List  
**\$27-50**

Write for Details  
**The TURNER CO.**  
904 17th St. N.E.  
CEDAR RAPIDS, IOWA

Licensed Under Patents of The Brush Development Co.

# More NEW Products IN STOCK!



## New CATHODE MODULATED Kit

200 Watt Cathode Modulated Transmitter  
using New RCA 812 tubes

Complete kit of parts for modulator and Class C including panels, punched chassis and B.&W. coils for one band. . . . . Net **\$36.50**  
1 Set RCA tubes, Audio and RF. . . . . Net **\$12.92**  
3 Triplett 227 meters. . . . . Net **\$5.87**  
Power supply for above complete with tubes, switches, safety lights, panel, and punched chassis. . . . . Net **\$46.95**

## New RCA Zirconium Coated ANODE TUBES

Type 811 — Hi mu 225 watts input  
Type 812 — Low mu 225 watts input

Requires only 6 1/2 watts Driving Power

For either type only. . . . . Net **\$3.50**

## New BUD XT25 Kit

25 Watt Transmitter or Exciter unit. . . . . Net **\$18.00**  
Complete with RCA 802 — 2 6L6G Ceramic Base tube 3 inch meter and coils for any band. . . . . Net **\$29.50**

## New ASTATIC Dynamic Microphone

Equipped with plug connector and tilting head. Net, only **\$11.75**

## New MILLEN HETROFIL. . . . . Net \$3.50

## New BRUSH High Fidelity Phonograph Pickup

Model PL-20 — with polished sapphire stylus. . . . . Net **\$22.50**  
Model PL-50 — with polished sapphire stylus. . . . . Net **\$45.00**  
Write for descriptive folder

## PHOTOELECTRIC ALARM

Complete with light source, chime gong and mirror. Net, only **\$12.50**  
Write for descriptive literature

## ALL STANCOR TRANSMITTER KITS IN STOCK

## LUCITE

## Unbreakable Feeder Spreaders

3" . . . . . Net 15c  
4" . . . . . Net 18c  
6" . . . . . Net 21c

## STACO Antenna Relay

110 V AC. — 4 Amp. contacts. Net, only. . . . . **\$2.55**

EXPORT ORDERS SOLICITED  
Mail Orders Promptly Filled

OUR *Best* VALUE IS OUR RECORD OF LOYAL SERVICE

# HARVEY

Radio Company of New York

103 WEST 43rd STREET • NEW YORK, N. Y.

CABLE ADDRESS: "HARADIO"

W9TCK/9	Chokio Amateur Radio Club <sup>49</sup>	92-A-5	1269
W6IRV/6	San Joaquin Valley Radio Club <sup>50</sup>	95-A-4	1260
W8OAJ/8	Valley Key and Mike Club <sup>51</sup>	73-A-2	1260
W9EQP/9	Milwaukee Radio Amateurs' Club, Inc. <sup>52</sup>		
VE3JJ	West Side Radio Club <sup>53</sup>	88-A-3	1260
W8MGQ/8	Key Klif Klub of Detroit <sup>54</sup>	77-A-1	1224
W8HQW/8	Finger Lakes Transmitting Society <sup>55</sup>	64-A-2	1215
W8MLV/8	Aerial Radio Club <sup>56</sup>	101-AB-1	1203
W4DW/4	Raleigh Amateur Radio Club <sup>57</sup>	80-A-1	1143
VEIMK	Halifax Amateur Radio Club <sup>58</sup>	107-B-3	1104
W5WG/5	Louisiana Tech Radio Club <sup>59</sup>	77-A-3	1071
W6BOS/6	Palomar Radio Club <sup>60</sup>	68-A-3	1062
W8MCL/8	Bluefield Amateur Radio Club <sup>61</sup>	73-A-4	1035
W1AQ/1	Associated Radio Amateurs of Southern New England, Inc. <sup>62</sup>	41-A-1	972
W8RDA/8	Toronto Amateur Radio Club <sup>63</sup>	47-A-1	963
		63-A-1	954

<sup>60</sup> W6KUT, W6ONX, W6JPU, W6OWL, W6IRV, W6QOS, W6KWA, W6JWS, W6NJP, W6JCB, W6FNR, W6QOO, W6PBJ, <sup>61</sup> W8OAJ, W8MIV, W8YQ, W8BVP, W8QHS, W8RQ, W8CBA, W8LHA, W8KCT, <sup>62</sup> Participants not listed.  
<sup>63</sup> VE3AD, VE3CB, VE3AW, VE3AP, VE3ANQ, VE3APO, VE3AIB, VE3LR, VE3AXG, VE3AHV, VE3AED, <sup>64</sup> W8KXX, W8MGQ, W8OOR, W8RMI, <sup>65</sup> W8BGV, W8DSU, W8HQW, W8CTJ, W2LWI, W8NQC, W8BDV, <sup>66</sup> W8JTI, W8OYL, W8OAE, W8NXL, W8NYV, W8EXL, W8FVQ, W8GIM, W8RIM, W8NJC, W8FIC, W8SJJ, W8SLL, W8TOL, W8LTP, W8NYP, W8TBE, <sup>67</sup> Participants not listed.  
<sup>68</sup> VEIHK, VEIKG, VEIHL, VEIEU, VEIMZ, VEIBC, VE4AT, VEIKK, VEIJM, VE3AL, VEIFO, <sup>69</sup> W5AXD, W5CTU, W5DRX, W5PUS, W5FVD, W5GUX, W5ECB, W5HBN, W5WG, <sup>70</sup> W6NKR, W6JRD, W6PDE, W6NGU, W6QCI, W6NFI, W6SOS, W6DLZ, W6CLT, W6RWM, W6HUR, W6AIN, W6KBU, W6MCL, W6MCR, W6MOP, W8NAU, W8OFE, W8SBU, W8SVE, W3AAF, <sup>71</sup> WILAB, WIKWA, WIBOY, W8RJC, WICPV, <sup>72</sup> W8RDA, W8OVN, W8RUE, W8QCZ, <sup>73</sup> W8HKT, W8JZD, W8PYA, W8SCS, W8SDE, W8RAE, <sup>74</sup> W8SEF, W8NTJ, W8SVP, W8NBD, W8PMY, W8EIKU, W8LIG, W8TQJ, W8BOZ, W8ITQ, <sup>75</sup> W5AFW, W5BRR, W5FVK, W5GAL, W5BJZ, W5HPM, W5HMV, W5GEB, W5MH, W5HEZ, W5GXQ, W4BGQ, Hollander, <sup>76</sup> W4DLJ, W4ESQ, W4CFA, W4FVM, W4DQE, W4FCH, W4ERK, W4JZC, W6GZC, W6RGN, W6MYJ, W6RKN, W6NFI, W6SOS, W6DLZ, W6CLT, W6RWM, W2MHV, <sup>77</sup> W3FUM, W3GPH, W3HOS, W3EYV, W3SWV, W3IAY, W3EUC, <sup>78</sup> WIKHE, WLAGW, W1JJY, W1CBZ, WIKU, W1ICA, W1HQL, <sup>79</sup> W9CTN, W9TMD, W9YMF, W9TSN, W9RLA, W9VJD, <sup>80</sup> W9ADJ, W9KYV, W9YOB, W9KNY, W9YJZ, W9CWC, W9ANV, W9APT, W9AOZ, W9MOP, W9AQO, W9CQO, <sup>81</sup> W9TQL, W9PGW, W9PCZ, Nestladek, Zienty, <sup>82</sup> Four participants, <sup>83</sup> W5A YE, W5BRX, W5L, W5ERS, W5FCM, W5FDQ, W5FFV, W5FHZ, W5FWZ, W5GJN, W5GJJ, W5GJZ, W5GRQ, W5GLD, W5HGX, W5HKK, W5HJQ, W5HJW, W5HJZ, W5LW, W5WV, <sup>84</sup> W5CTA, W5GNV, W5GNX, W5GLV, W5GVX, W5BRV, Anderson, Clark, Williams, Johnson, Claborn, <sup>85</sup> W1B8G, W1HA, W1JY, W1JFX, W1FGX, W1PG, W1LWM, W1RH, <sup>86</sup> W1KIK, W1LQS, W1AUN, W1ADE, W1DCE, W1LBN, W4E0S, W4RDA, W4EID, W4EUD, W4EAL, W4ECC, <sup>87</sup> W4ECP, W4EY, W4EY, W8QNM, W8AFE, W8QBE, W8QKL, W8QKS, W8RRQ, <sup>88</sup> W9PNV, W9PEQ, W9HIY, W9GUW, W9GGK, W9DGG, W9STF, Freeman, Gable, <sup>89</sup> W7FRS, W7BBD, W7XFE, W7HCR, W7CHG, W7GJC, <sup>90</sup> W9AZN, W9AKY, W9EXE, W9GQV, W9HSH, W9VYZ, W9QDL, W9OME, <sup>91</sup> W3GZ, ex-W3FQV, W3GKR, W3GLW, Levy, <sup>92</sup> W8V8, W9HFG, <sup>93</sup> Five participants, <sup>94</sup> W9JVC, W9TLC, W9NGG, W9NLU, W9QLZ, W9VFS, W9BIN, W9NOO, W9ZEN, W9LNI, W9TAY, MacLennan, Ishewski, Balzarini, <sup>95</sup> W8PTW, W8IXJ, W8QGD, W8QQK, <sup>96</sup> Participants not listed, <sup>97</sup> W8JUG, W8QGS, W8QDS, W8EJH, W8TJH, W8TLE, W8SHC, W8RFX, W8RNE, W8TPO, W8NXQ, W8PKA, <sup>98</sup> W9LJL, W9LJN, W9BJJ, W9ZOL, W9GCV, W9KCR, W9BPA, W9CJC, W9BMB, W9ZHH, W9VWU, W9TWI, W9VQA, W9JXD, W9GRA, <sup>99</sup> W3FIE, W3FKP, W3AXL, W3PWL, W3GOM, Humphries, W3RE, <sup>100</sup> W5CNG, W5GPE, W5HLD, W5HGD, W5DKG, W5HJQ, W5HJW, W5HJZ, W5EKK, <sup>101</sup> W8KNT, W8EMV, W8GMI, W8EEL, W8AQ, W8QJL, W8JYJ, W8QJK, W8BDD, W8LFJ, W8RPS, W8DXE, <sup>102</sup> W6DSD, W6GJG, W6MQA, W6FT, W6MMH, <sup>103</sup> Twelve participants, <sup>104</sup> VE5UZ, VE5AFJ, VE5FB, 14 participants, <sup>105</sup> VE5OE, VE5AAE, VE5RS, VE5EV, VE5ET, VE5R3, VE5BQ, VE5EA, VE5ET, <sup>106</sup> Participants not listed, <sup>107</sup> Ten participants, <sup>108</sup> Participants not listed, <sup>109</sup> VE4FK, VE4AFG, VE4NF, VE4ALU, <sup>110</sup> W9UEL, W9WTV, W9WZI, W9ZNL, W9QIS, W9NVS, W9NNY, W9WTN, Bunca, Fabian, Harmon, Howe, <sup>111</sup> W8SRD, W8SDF, W8SSL, W8QPK, W8SRW, W8SBU, <sup>112</sup> W6EJZ, W6NGQ, W6MYL, W6OEF, W6RCH, <sup>113</sup> Participants not listed, <sup>114</sup> Seven participants, <sup>115</sup> W2BKZ, W2DGD, W2FWX, W2HDG, W2IDD, W2LFX, W2LIW, W2KPM, W2LKR, <sup>116</sup> W9HYX, W9GFE, W9OBA, <sup>117</sup> W5HGC, W5HBB, W5GOL, W5GAE, W5HLX, W5GAQ, W5HRS, W5HQE, W5CCB, W5AQE, W5BST, W5GTU, <sup>118</sup> K6ZAZ, K6AYD, K6CFM, K6PED, K6QIC, K6PLU, <sup>119</sup> W8PXY, W8RW, W8OEN, <sup>120</sup> Participants not listed, <sup>121</sup> W9VJL, W9UEQ, Koehler, <sup>122</sup> W9YDJ, W9EIP, W9DVX, W9JCT, <sup>123</sup> Seven participants, <sup>124</sup> W9VTO, W9SZU, W9FRY, W9VNM, W9OXK, <sup>125</sup> W6KMM, W6KVL, W6KFC, W6HW, <sup>126</sup> W1BCG, W1GKU, W1CTI, W1EER, W2AHL, <sup>127</sup> 25 Participants not listed.



# GAMMATRONS *Span the Oceans*

WITH PAN AMERICAN CLIPPERS

Gammatrons were selected by this great air line to insure reliable communication essential to safe air travel. Enjoy the same reliable performance, write for data.

PAN AMERICAN CLIPPER  
OVER TREASURE ISLAND



## PRECISION CRYSTALS

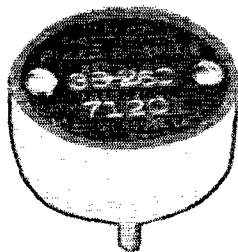

Highest quality crystals carefully prepared for dependable performance.

Low frequency drift Type 4-A unit plugs into tube socket, 40, 80 or 160 meter bands, within 5 kc. of your specified frequency — \$4.00. Calibration 0.03%.

'X' cut in Type 4 holder — \$3.50.

Crystals for commercial requirements quoted on at your request. Now in our Tenth year of business.

**PRECISION PIEZO SERVICE**

427 Asia Street

Baton Rouge, La.

## ANNOUNCEMENT

# "HQ-120-X"

**NEW LIST PRICE \$230.00**

See pages 4 and 5 for "HQ-120-X" and "Super-Pro" receivers going on the Byrd Expedition to Little America.

**HAMMARLUND MFG. CO., INC.**  
424 West 33 Street New York City

## MEMORANDUM

- ✓ You need a copy of the new 1940 Handbook.
- ✓ You need a binder for your 1939 *QST's* — and another for 1940.

★



Xmas suggestion — give a membership-subscription or a new Handbook.

**DECEMBER, 1939**

# SUPER ACTIVE

# HIPOWER

## LOW DRIFT CRYSTAL UNITS



### LOOK! LOOK! GENUINE LOW DRIFT "EMERALDS" AT "X" CUT PRICES

Now get stability plus higher activation with these new sensational crystal units. The entire ham band is talking about HiPower "Emeralds." Because of large production facilities and exclusive HiPower grinding methods, these low drift cut units meet every test of usage, accuracy, and price.

SEND FOR CATALOG TODAY

160—80—40 meter band*	<b>\$3.35</b>
20 meter band	5.50

Ask your parts distributor about HiPower "Rubies." These jewels of crystal craftsmanship — priced reasonably — meet commercial standards at true amateur prices.

Newark, Chicago, Radio Parts, Madison & Milwaukee, Kerrs Radio Shop, El Paso, Tex. Radio Electric Service Co., Baltimore, Md. Walder Radio & Appliance Co., Miami, Florida.

**HIPOWER CRYSTAL COMPANY**  
2035 CHARLESTON ST. CHICAGO, ILL.

W8HKT/8	Southwest Michigan Radio Club <sup>64</sup> .....	46-A-1	909
W8ESR/8	Warren County Amateur Radio Assn. <sup>65</sup> .....	74-AB-1	897
W5AFW/5	Baton Rouge Amateur Radio Club <sup>66</sup> .....	68-AB-2	876
W4DIJ/4	Lookout Amateur Radio Club <sup>67</sup> .....	89-AB-1	843
W6OOZ/6	University of Calif. Radio Club <sup>68</sup> .....	62-AB-3	840
W2GTW/2	Delaware Valley Brasspounders Assn. <sup>69</sup> .....	34-A-1	837
W3EUC/3	Harrisburg Amateur Radio Club <sup>70</sup> .....	43-A-1	837
W1KHE/1	New Bedford Radio Operators Assn. <sup>71</sup> .....	73-B-1	828
W9MWJ/9	Tri-Town Radio Amateur Club <sup>72</sup> .....	58-A-3	810
W9ADJ/9	Black Hills Amateur Radio Club <sup>73</sup> .....	80-AC-3	777
W8SG/8	Dennison University Radio Club <sup>74</sup> .....	39-A-1	765
W1BKJ/1	Pittsfield Radio Club <sup>75</sup> .....	32-A-1	720
W3EEI/3	Mike and Key Club of Baltimore <sup>76</sup> .....	40-A-1	720
W5FBI/5	Ponca City Key Clickers and N.C.R. <sup>77</sup> .....	41-AB-1	717
W1GAN/1	Green Mountain Radio Club <sup>78</sup> .....	40-A-4	711
W9PCZ/9	Berwyn Amateur Radio Club <sup>79</sup> .....	47-A-1	693
W2LEI/2	Albany Radio Club <sup>80</sup> .....	30-A-1	675
W5IAS/5	Tulsa Amateur Radio Club <sup>81</sup> .....	44-A-6	675
W5FKU/5	Sabine District Amateur Radio Club <sup>82</sup> .....	20-A-2	648
W1LRN/1	Hi-Q Radio Club <sup>83</sup> .....	52-B-3	642
W1KIK/1	Chair City Radio Assn. <sup>84</sup> .....	31-A-2	639
W4EOE/4	Jacksonville Radio Club <sup>85</sup> .....	31-A-1	630
W8IBU/8	Trico Radio Club <sup>86</sup> .....	46-A-2	630
W9PNV/9	Chicago Suburban Radio Assn. <sup>87</sup> .....	53-AB-3	606
W7FRS/7	Butte Amateur Radio Club <sup>88</sup> .....	49-A-1	603
W9AZN/9	LaCrosse Radio Amateur Club <sup>89</sup> .....	22-A-1	585
W3GIW/3	Ether Agitators <sup>90</sup> .....	78-B-1	556
W9VS/9	Chicago Radio Traffic Assn. <sup>91</sup> .....	31-A-1	531
W1INM/1	Providence Radio Assn. <sup>92</sup> .....	23-A-1	522
W9MKS/9	Starved Rock Radio Club <sup>93</sup> .....	58-ABC-3	522
W8NLG/8	Detroit Amateur Radio Assn. <sup>94</sup> .....	19-A-1	495
W1GB/1	New Haven Amateur Radio Assn. <sup>95</sup> .....	145-AC-3	492 rT
W8JUG/8	Central New York Radio Club <sup>96</sup> .....	68-AB-2	489 rt
W9GRA/9	Topeka Amateur Radio Operators <sup>97</sup> .....	111-A-3	483 RT
W3REK/3	Ultra High Frequency Club of Phila. <sup>98</sup> .....	34-A-3	477
W5CNG/5	Monroe Amateur Radio Club <sup>99</sup> .....	30-A-1	459
W8KNF/8	Medina County Radio Club <sup>100</sup> .....	28-A-4	459
W6MML/6	Glendale Amateur Radio Club <sup>101</sup> .....	42-A-2	441
W5DIG/5	Galveston Amateur Radio Club <sup>102</sup> .....	33-B-2	426
VE5FB	Jr. Point Grey Amateur Radio Club <sup>103</sup> .....	31-A-1	414
VE5EP	West End Amateur Radio Club <sup>104</sup> .....	40-A-1	405
W4GB/4	Palmetto Amateur Radio Club, Inc. <sup>105</sup> .....	41-B-1	402
VE3RH	Key Klick Klub, Toronto <sup>106</sup> .....	29-A-2	396
W9OKY/9	Pikes Peak Amateur Radio Assn. <sup>107</sup> .....	28-A-1	396
VEANQ	Calgary Amateur Radio Assn. <sup>108</sup> .....	20-B-1	384
W9UEL/9	San Isabel Amateur Radio Assn. <sup>109</sup> .....	34-B-1	372
W8FVY/8	Youngstown 5 & 10 Meter Club <sup>110</sup> .....	29-A-1	361
W6HXP/6	Bell Radio Club <sup>111</sup> .....	64-A-1	342 rt
W4DUG/4	Tampa Amateur Radio Club <sup>112</sup> .....	49-A	318
W8INE/8	Boys' Club of St. Mary's Amateur Radio Soc. <sup>113</sup> .....	15-B-1	294
W2SV/2	Sunrise Radio Club <sup>114</sup> .....	20-A-2	279
W9OBA/9	The Hibbing Brass Pounders <sup>115</sup> .....	30-B-1	276
W5HGC/5	OhPeKah Club <sup>116</sup> .....	29-A-2	261
K6FAZ/K6	Maui Amateur Radio Club <sup>117</sup> .....	34-B-1	216
W8APJ/8	Bluffton Amateur Radio Club <sup>118</sup> .....	26-A-1	204 R
W9UNL/9	Iowa-Illinois Amateur Radio Club <sup>119</sup> .....	14-A-1	193
W5HTE/5	Enid Amateur Radio Club <sup>120</sup> .....	19-AB-1	159
W9ANR/9	Chicago Radio Traffic Assn. <sup>121</sup> .....	18-B-1	156
W9YDJ/9	Freeport Amateur Radio Club <sup>122</sup> .....	20-A-1	156
W8FEB/8	Fostoria Wireless Assn. <sup>123</sup> .....	15-AB-2	144
W9VLO/9	Goshen Amateur Radio Club <sup>124</sup> .....	31-A-1	138 RT
W6KFC/6	Radio Club of Arizona <sup>125</sup> .....	13-A-1	111

# COTO HIGH POWER INDUCTORS

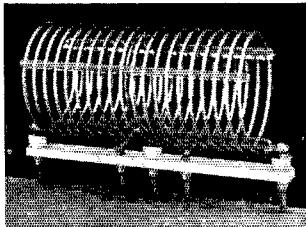

ALL TYPES

ALL BANDS

Are Now Made with  
"FORMEX"

Toughest and Most Flexible  
Covered Wire Available

Inductors from a "Pee-Wee" to a Kilowatt

New Low Prices on Control Wheels and Chokes

SEE YOUR NEAREST JOBBER  
FOR COMPLETE LINE OF PARTS

RADIO

Coto

PRODUCTS

PROVIDENCE

RHODE ISLAND

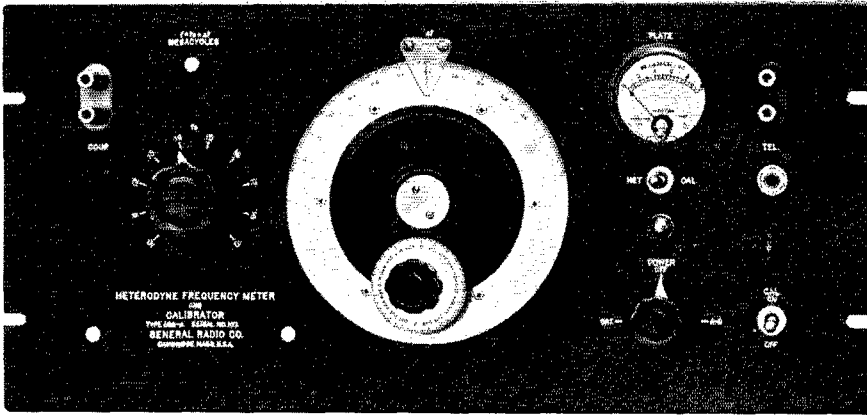

● **SEVERAL IMPROVEMENTS** in the G-R Type 620-A Heterodyne Frequency Meter and Calibrator further increase the accuracy of this popular Monitor for all types of high-frequency use. It is now supplied with an engraved dial on the slow-motion control so that it can be read directly to an accuracy of 0.01%. It accordingly is suitable for use in all stations with an allowable tolerance of 0.01%. Its price, in the relay rack model, is . . . . . **\$490.00**

● WRITE FOR BULLETIN 512 FOR INFORMATION

## GENERAL RADIO COMPANY, CAMBRIDGE, MASS.

### EASY TO LEARN CODE

It is easy and pleasant work to learn the modern way — with an Instructograph Code Teacher. Ideal for the beginner or advanced student. ■ Many tapes available ranging from alphabet for beginners to typical messages on all subjects. Speed range 5 to 40 WPM. ■ Always ready, no QRM, beats having someone send to you.



**FOR SALE OR RENT**  
**STANDARD** with 10 tapes and book of instructions, A. C. motor . . . . . \$24.50  
 With spring-wound motor . . . . . \$18.50  
**JUNIOR** with 5 tapes and book of instructions (not rented) . . . . . \$12.00

**RENTAL** Standard with 10 tapes and book of instructions \$3.00 first month, \$2.25 each additional month. References or \$10 deposit required. All rental payments may be applied on the purchase price should you decide to buy the equipment.

*Write for details today*

### INSTRUCTOGRAPH COMPANY

Dept. Q, 912 Lakeside Place, Chicago, Illinois  
 Representative for Canada:  
 Radio College of Canada, 863 Bay Street, Toronto

## BRAZILIAN QUARTZ CRYSTAL

Largest and most varied stock of Brazilian quartz crystals in the United States. Finest quality suitable for manufacturing piezo-electric crystals, lenses, and prisms. Shipments received regularly from our Brazilian Branch. Also in stock tourmalines for making crystals to control the higher frequencies and quartz for fusing purposes.

**BRAZILIAN TRADING CO., INC.**  
 377 Fourth Avenue New York City  
 Murray Hill 4-2891

## BE *Santa Claus* TO YOUR FRIENDS . . .

 *QST* can help you with your Christmas list. Each year an increasing number of individuals find it to be the ideal gift. A subscription present is unique, too. It serves as a monthly reminder of your thoughtfulness. A yearly subscription, including League membership, costs only \$2.50, little enough for the ones you have in mind. And — we'll send an appropriate gift-card conveying your Christmas Greetings at the proper time.

*A Monthly Reminder of Your Thoughtfulness and Good Judgment*

**QST**

38 La Salle Road West Hartford, Conn.

# OHMITE RESISTORS

**Proved Right  
in Amateur Rigs  
Everywhere!**

Be sure of continuous, trouble-free performance and maximum efficiency in every stage of your transmitter! Get Ohmite Vitreous-Enamelled "Brown Devil" Resistors, "Dividohm" Adjustable Resistors and other Ohmite parts from your Jobber.

Write Today for Catalog 17

**OHMITE MFG., CO.**  
4865 Flounroy St., Chicago, U.S.A.

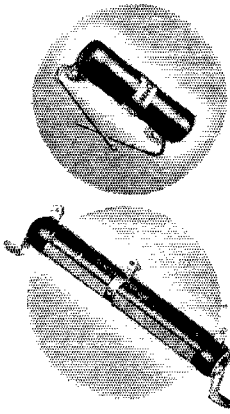

# OHMITE

RHEOSTATS RESISTORS TAP SWITCHES

## THIS EXPERT WILL HELP YOU PASS THE NEW RADIO EXAMS



Newly-written, low-cost, home-study courses under supervision of Arthur R. Nilson, twenty years co-author of technical radio books. Fit yourself for the new license examinations — Radio Telephone Operator 1st or 2nd class and Radio Telegraph Operator's permit, used in the Aeronautical, Forestry and Police services and Broadcasting. Thousands of professional radiomen use Nilson and Hornung textbooks to keep up to date. Now Arthur R. Nilson, will give you direct, detailed lessons, step by step.

SEND FOR FREE 16-PAGE BOOKLET "What The Modern Radioman Must Know." Make this step toward your successful radio career ... now!

**NILSON RADIO SCHOOL**  
51 East 42nd St., New York, N. Y.

Please send me without obligation, your booklet "What The Modern Radioman Must Know."

Name \_\_\_\_\_  
Address \_\_\_\_\_  
City \_\_\_\_\_ State \_\_\_\_\_ Q-12



W1CBA/1	Connecticut Brasspounders Assn. <sup>158</sup>	19-C-1	87
W2JIQ/2	Tu-Boro Radio Club <sup>157</sup>	4-A-1	63
VE1LC	Loyalist City Amateur Radio Club <sup>158</sup>	---	54

### Individual and Group Scores

W9V8X/9	W9EJ-W9GFG-W9GFS-W9EWN-W9IMV-W9JZY-W9MRQ-W9MUZ-W9SXZ-W9TJD-W9TUV-W9V8X-W9YZV-W9ZCH-Haenle-Kimball-Woods	204-A-4	2952
W8QAN/8	W8QAN-W8AIG-W8UK	156-A-2	2430
W8BQ/8	W8BLT-W8FLA-W8GSS-W8LRM-W8AKH-W8AHR-W8FMP-W8ASW-W8MCX-W8RHE-W8JHP-W8RZK-W8AZT-W8FDA-W8OML-W8TJU-W8PAF-W8EKG-W8WJ-W8BQ	148-A	2403
W8NAB/8	W8QOK-W8NAB-W8OFN-W8JEA-W8SJF	104-A-1	1971
W8CL/8	W8RV-W8JTH-W8IEG-W8LIW-W8MQX-W8CL	108-A-1	1854
W6NIK/6	W6JQX-W6NIK-W6MTC-W6NYA-W6LXS	126-A-4	1817
W8DS/8	Greater Cleveland Emergency Planning Committee	115-A-3	1656
W1EH/1	W1JFN-W1LVQ-W1JPE-W1JEQ-W1EH	98-A-1	1629
W4RO/4	W4ENE-W4CVB-W4FFF-W4RO	95-A-1	1602
W9ARN/9	W9FXZ-W9BME-W9FHR-W9ARN	99-A-2	1557
W9FPO/9	W9DTB-W9FPO-W9REX-W9WYY	104-A-1	1521
W3GJG/3	W3BTQ-W3GJG-W3DUK-W3CHG-W3GYQ	81-A-1	1494
W2SC/2	W2LDQ-W2HMJ-W2HU Y-W2KMN-W2GPY-W2JRF-W2HUX-Burtis	125-B-2	1470
W2ERJ/2	W2HGS-W2CLH-W2ERJ-W2ECK	70-A-1	1377
W9VDY/9	W9VDY-W9YEG	73-A-1	1350
VE3GZ	VE3PO-VE3QU-VE3GZ-VE3DO-VE3VJ	70-A-1	1341
W3GOA/3	W3FCF-W3FEW-W3HQU	78-A-1	1296
W9TEW/9	W9TEW-W9WNG	82-A-1	1224
W3BEK/3		85-A	1206
W4VX/4	W4EMC-W4CYC-W4ECZ-W4VX	80-A-1	1206
W3HUZ/3	W3BCA-W3EHY-W3H0J-W3HRJ-W3HUZ-W3IFT	82-AB-2	1062
W9QXG/9	W9QXG-W9ZAW	92-A-1	1050 T
W5AZB/5	W5AZB-W5DXA-W5EAV-W5EOE-W5HFN-W5HTH	64-A-1	1008
W8VZ/8		80-AB-1	1005
W9WKL/9	W9WKL-W9QYZ	55-A-1	980
W5GPJ/5	W5EWB-W5FMQ-W5DV-W5GPJ-W5FSU-W5CV-W5GBB-W5HKB-W5HVZ-W5IDR-W5HDU	75-A-2	984
W1BB/1	W1BB-W1BDU-W1LMO-W1HFJ	55-A-2	983
W6GTM/6	W6BBR-W6GTM-W6ISG-W6ITY-W6MUS	74-A-2	963
W8BDM/8		75-A-1	936
W8NOT/8	W8MCQ-W8MJG-W8NOT-W8NUO-W8NXN-W8OTR	91-A-1	930 T
W2CEN/2	W2MDI-W2CEN-W2KOA	46-A-1	900
W8FBC/8	W8FBC-W8LEV-W8PRD-W8NJ	53-A-2	864
W6MRB/6	W6KEV-W6MSM-W6MRB-Sweeney	62-A-3	855
W6BAM/6	W6IBN-W6RBA-W6NRM-W6BFE-W6BAM	51-A-2	837
W9ERU/9	W9ERU-W9AIC-W9FFQ-W9AGV-W9TET-W9EQZ	44-A-3	837
W9YAW/9	W9VIS-W9YAW-W9SEJ	53-A-2	801
W1LNI/1	W1LNI-W1CRP-W1JRS	54-A-1	792
W8DSZ/8	W8DSZ-W8LCO-W8RHG-W8NPF	30-B-1	780
W6QAP/6	W6QAP	50-A-1	747
W8AKN/8	W8AKN-W8DWG-W8NXT	43-A-1	747
W9SVH/9	W9SVV-W9FWS-W9AKJ-W9SVH	44-A-1	747
W2GBY/2	W2GBY-W2FSQ-W2EKU	63-B-1	702
W8KO/8	W8KO	45-A-1	684
W8MJK/8	W8MJK-W8EIS-W8RUF	42-A-1	675
W2ISJ/2	W2LA-W2LDS-W2ISJ	38-A-1	648

# Introducing ARMSTRONG FREQ. MODULATION

BROWNING FREQUENCY MODULATION  
COMPONENTS NOW AVAILABLE

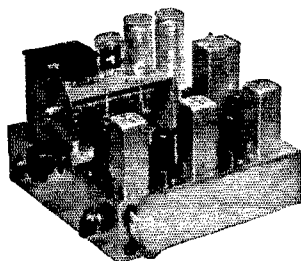

3 Mc. IF Amplifier consisting of the mixer circuit, two IF stages, limiter, detection system, and output volume control with a-c. switch built on 10 1/2" X 9 1/2" chassis with all holes punched for RF tuner, power supply and push-pull audio power amplifier. IF amplifier wired and carefully aligned. Type BL-3,000A. Amateur Net Price. . . . . \$24.90

High Frequency RF Tuner, wired, and aligned. Consists of a tuned antenna circuit, one stage of radio frequency amplification, and an oscillator circuit. Covers a frequency range from approximately 40 to 54 Mc. Type BL-40T. Amateur Net Price. . . . \$11.70

4" Sun-Ray Finish, nickel silvered vernier drive dial for Tuner. Type BL-40V. Amateur Net Price. . . . \$2.10

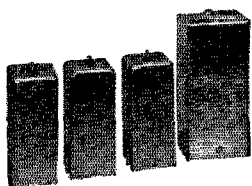

3 Mc. IF and Detection Transformers with band widths of 200 Kc. for High-Quality noiseless reception.

3 Mc. Interstage transformers. BL-3M. Amateur Net Price. . . . . \$1.20

3 Mc. Detection transformers. BL-3D. Amateur Net Price. . . . . \$3.75

NATIONAL—HAMMARLUND  
HOWARD RECEIVERS

Available on Regular Time Payment Plan

## H. JAPPE COMPANY

46 CORNHILL — BOSTON, MASS.  
WORCESTER, MASS. DOVER, N. H.

# RECEIVERS

## FEATURED THIS MONTH AT TERMINAL'S

Two Conveniently Located Stores

• 68 WEST 45TH ST. (MIDTOWN)

• 80 CORTLANDT ST. (DOWNTOWN)

Let us demonstrate these sets to you!

*TERMINAL is the best stocked amateur equipment distributor in New York City!*

### HAMMARLUND HQ120X

An extremely dependable and efficient receiver at a moderate price. Includes many exclusive Hammarlund features. Equipped with all tubes, crystal, "S" meter and speaker. . . . .

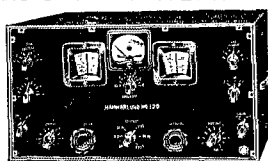

**\$138.00**

### hallicrafters SKYRIDER "DEFIANT"



Looks and performs like a more expensive receiver. Its keen reception will amaze you! Complete with all

tubes, crystal, "S" meter, less speaker. . . . . **\$69.00**

### hallicrafters SKY CHAMPION

NEW! Radical improvements over the previous model! Now an exceptional value for. . . . . **\$49.50**

### NATIONAL RECEIVERS in stock

NC-44. . . . . \$49.50 NC-100XA. \$142.50  
NC-80X. . . . . 99.00 NC-101X. . . . . 129.00

CATHODE  
MODULATION  
transformers in stock.  
Kenyon • U'IC • Thordarson

FREQ.  
MODULATION  
Browning kits and parts  
in stock, on demonstra-  
tion.

Mail Orders Filled — Literature Forwarded

# TERMINAL Radio Corp.

68 West 45th St. • 80 Cortlandt St.  
2 stores in NEW YORK CITY  
Vanderbilt 6-5050 • Cable: TERMRADIO

A winner for every ham...

THIS 5" RCA OSCILLOGRAPH

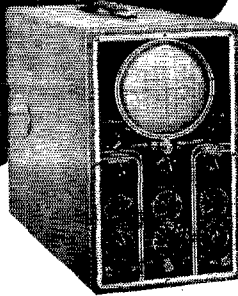

Reflecting all of RCA's skill and experience in oscillograph manufacture, this 5" RCA Oscillograph is a winner for general use. Frequency characteristic vert. amp. (gain max.): 3 cycles to 50 kc, essentially flat. Horiz.: 5 cycles to 100 kc, essentially flat. Stock No. 160... Net price \$130.00. Designed especially for television, but ideal for many amateur applications is another 5" RCA Oscillograph, Stock No. 158. Frequency

characteristic vert. amp. (max. gain): 5 cycles to 500 kc. Horiz.: 5 cycles to 100 kc... Net price \$147.50. Horiz. Sweep Freq. Range of both oscillographs: 4 cycles to 22,000 cycles.

Over 335 million RCA radio tubes have been purchased by radio users... In tubes, as in parts and test equipment, it pays to go RCA All the Way.



Test Equipment

RCA Manufacturing Co., Inc., Camden, N. J.  
A Service of Radio Corporation of America

# RADIO

**ENGINEERING,** broadcasting, aviation and police radio, servicing, marine telegraphy and telephony, Morse telegraphy and railway accounting taught thoroughly. 48 weeks' engineering course, equivalent to three years of college radio work. School established 1874. All expenses low. Catalog free.  
DODGE'S INSTITUTE, Day Street, Valparaiso, Indiana

Be a Champion with a Genuine **VIBROPLEX "CHAMPION"**

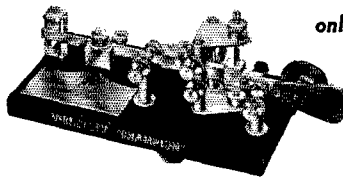

only \$9.95

At Your Dealer's

Standard size base. Black crackle finish. All machine parts chrome plated. Standard contacts same as more expensive models. Furnished without circuit closer, cord and wedge.

## A "STAR" Performer

Like all true champions, this new Vibroplex "CHAMPION" defies competition. Handsome in design, sturdily built and a "STAR" performer... the "CHAMPION" is our answer to the demand for a BUG of established quality, proved sending ability and assured ease of operation at a price within the reach of everyone. Designed primarily for the amateur, professional operators will find the "CHAMPION" amply qualified to give an expert account of itself on any assignment. See the "CHAMPION" at your dealer's to-day. If he cannot supply you, write or order direct from us. Money order or registered mail. Write for illustrated catalog.



The BUG trade mark identifies the Genuine Vibroplex

THE VIBROPLEX CO., Inc.

832 Broadway

New York, N. Y.

W1HDQ/1	W1EOB-W1HDQ-W1GUY.....	53-A-1	642
W3FQB/3	W3EJB-W3FQB.....	34-A-1	630
W3HMJ/8	W3HMJ.....	24-A-1	585
W2LR/2	W2CTN-W2ITX-W2LR.....	26-A-1	576
W3GAC/3	W3GAC-W3EHV-W3FQZ- W3FRB-Clements.....	102-C-1	567
W9UCL/9	.....	39-A-1	558
W4FRU/4	W4EWC-W4FRU.....	31-A-1	549
W9WGP/9	W9ESM-W9ZBY-W9YXH- W9YPO-W9WWD-Makou- ske-Strohecker-Derpinhaus- Zak-Amann-Wright.....	46-A-2	540
W3RR/3	W3RR-W3EEW.....	44-A-1	534 T
W3EYX/3	W3EYX-W3FNG-W3GXI- W3ES0-W3GKP-W3FVD.....	33-B-1	516
W9KBL/9	W9JZK-W9OBM-W9KBL-King.	105-AB-3	514 RT
W6OMC/6	W6OBJ-W6EY-W6NZY-W6OMC- VE2HI-VE2A Y-VE2KQ- VE2GY-VE2MY-VE2LI- VE2FG-VE2IM.....	36-A-1	513
W6HY/6	W6HY-W6EOP.....	24-A-1	495
W8CDR/8	W8CDR-W8LCO-W8SXT- W8CED-W8DLB.....	38-A	486
W5ARX/5	W5ARX-W5HOT.....	58-B-2	486
W9MWU/9	W9MWU-W9EVS.....	88-C-1	481
W8CTC/3	W8UQU-W8CTC-Fuller.....	33-B-1	480
W8SCW/8	W8SCW-W8SEK.....	35-A-1	468
W1BDI/1	W1BDI-R A. Handy.....	15-A-1	468
W1IMD/1	W1IMD-W1HWY-W1JVH- W1IVV-W1IER-W1LPZ- W1KVS.....	14-A-1	450
W1JYJ/1	W1IIT-W1JMY-W1JYJ- W1LAL.....	36-B-1	450
VE3ATJ	VE3ATJ-VE3AMJ-VE3AUI.....	15-A-1	450
VE2CD	VE2CD-VE2KH.....	20-A-1	441
W8FPG/8	W8FPG-W8NWX-W80WV- W80XE-Mills-W8PSA- W8PRY-W8IFF-W8RVB- MacMahon.....	32-B-1	438
W5GRL/5	W5GRL-W5HML-W5IDM.....	35-B-1	438
W8OPX/8	W8PMB-W8OPX-W8SBB.....	30-A-1	432
W9ESJ/9	W9ESJ-W9CAS.....	46-B-1	414
W9SFZ/9	W9KXJ-W9SFZ.....	14-A-1	414
W9VTD/9	W9HMB-W9VDH-W9VDT.....	27-A-1	414
W1JYX/1	W1JYX-W1LVX-W1LOR.....	28-A-1	396
VE50T	VE50T-VE50Q-VE5JT.....	23-A-1	378
VE1AW	VE1AW-VE1DB-VE1EK- VE1JH.....	32-A-1	361
W7RT/7	W7RT.....	30-B-1	360
W5FH/5	W5FH-W50I-Hamilton.....	13-A-1	360
W2JGF/2	W2JKD-W2KFC-W2JGF.....	25-A-2	351
W9MLG/9	W9MLG.....	19-A-1	336
W9AB/9	W9JHW-W9AB-W9WDV- W9ZYK-W9SVJ-W9GOE- W9ESH-W9HKP-W9CWE- W9OJM.....	19-A-1	333
W9QJG/9	W9QJG.....	18-A-1	315
W1JLT/1	W1JLT.....	24-A-1	297
W5DAQ/5	W5DAQ.....	20-A-1	288
W1JYS/1	W1JKQ-W1KUX-W1KWS- W1JVA-W1JYS.....	10-A-1	279
W5NY/5	.....	-----	273 RT
W5GNV/5	W5GNV-W5IDE.....	45-A-1	270 RT
W1BIV/1	W1BIV.....	19-A-1	261
W8BTQ/8	W88HK-W8RVZ-W8BTQ.....	30-A-1	234 RT
W9TQD/9	W9YFD-W9RDT-W9DI- W9TQD.....	24-B-1	234
W9THS/9	W9KYA-W9PVT-W8AWX-Day- Leger-Margin-Snapp-Berry- Hensley-Huffman-Pershing Platt-Thornbury.....	57-C-2	218
W8NGN/8	W8NGN.....	12-A-1	189
W6NVS/6	W6NVS.....	13-A-1	171
W2FBA/2	W2FBA-W2JBQ.....	18-A-1	162
W5GGS/5	W5GPQ-W5HMN-W5GGI- W5HOJ-W5HOK-W5GGS.....	15-A-1	162
W6KTY/6	W6KTY.....	12-A-1	144
W5GLS/5	W5GLS-W1JHC.....	13-B-1	132
W2LQ/2	W2LQ.....	14-A-1	132 RT
W1KKE/1	W1KKE.....	12-A-1	126
VE4AKK	VE4AEA-VE4AKK-VE4ADW.....	9-A-1	117
W6REP/6	W6REP-W6RDA-Badger.....	10-A-1	117
W8RVM/8	W8RVM-W8DHB.....	7-B-1	116 T
W8MQB/8	W8MQB.....	24-C-1	93
W1JVS/1	W1JVS.....	19-B-1	92



# Use Pyranol Capacitors, OM, They'll Fit

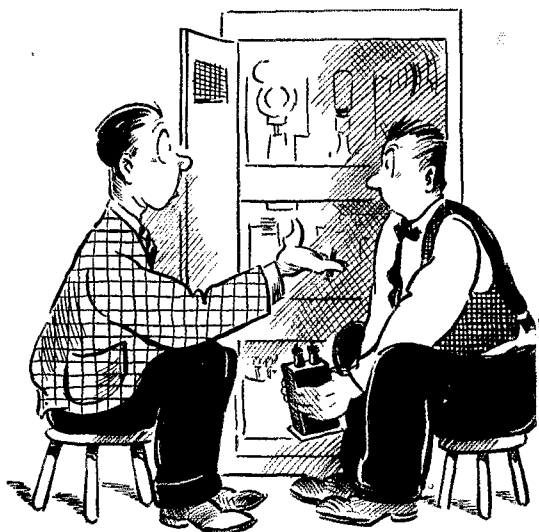

ARE you planning a new circuit or some other change in your transmitter? If so, you'll appreciate the unusually small size of G-E Pyranol capacitors, especially the cylindrical shapes.

Pyranol, the remarkable liquid dielectric, is the big reason why these capacitors are so compact. Its electrical characteristics are exceptionally high. Then, too, Kraft paper, foil, bushings, and other parts have been made to take the least possible space.

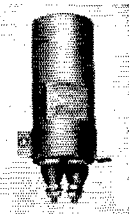

Cylindrical Pyranol capacitor

After assembly, each unit is completely impregnated and filled with Pyranol, and is hermetically sealed in an all-metal case. The finished capacitor is leak-proof and fire-proof. See your dealer to-day about Pyranol capacitors or write Radio Department, General Electric, Schenectady, N. Y.

**GENERAL**  **ELECTRIC**

900-18

## CHRISTMAS SEALS



Help to Protect Your Home from Tuberculosis

*The Perfect Christmas Gift for the "Ham"!*

### GORDON DX CLOCK

Here's the clock that every amateur wants to own! World time at a glance! Instantly tells GMT or local time in any of the 24 Time Zones. Waltham electric movement with 24-hour colored dial. Only \$9.00. See it at your nearest dealer's or write for complete information.

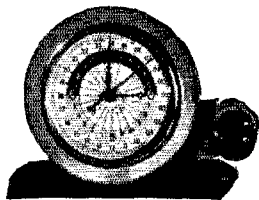

### GORDON SPECIALTIES CO.

1104 So. Wabash Ave.

Chicago, U. S. A.

**STUMPED by CODE?**  
**BAFFLED by THEORY?**

**HERE IS THE WAY OUT!**

We have put hundreds of amateurs on the air and can do the same for you!

WRITE US TODAY

**AMERICAN RADIO INSTITUTE**  
1123 Broadway, New York, N. Y.



wishes you

# A Merry Xmas

Here's How to Make Yours a Happy One!

**Suggested Xmas Gifts that will be enthusiastically appreciated by any Amateur and Short Wave Fan.**

## 1 A NEW RECEIVER

**HALLICRAFTERS SX-24 SKYRIDER DEFIANT.** This New set is taking the country by storm. It is sure to please the discriminating Amateur. Complete with tubes and crystal — **\$69.50.** Complete with tubes, crystal and speaker — **\$81.50.**

**HAMMARLUND HQ120X.** A set that has everything. Every Amateur recognizes this receiver as foremost and would be proud to own one. Complete — **\$138.00.**

**HOWARD 438.** A compact receiver that has performance equalling many sets at much higher prices. We recommend the Howard 438; A ruggedly built instrument. Complete with tubes and speaker — **\$49.95.** Complete as above and with crystal (model 438X) — **\$59.95.**

**HALLICRAFTERS SKY BUDDY.** A real Amateur receiver at a very low price. Complete — **\$29.50.**

**NATIONAL HRO.** The standard in Amateur reception. — The HRO needs no description. Complete with tubes, four sets of coils, speaker and cabinet, and power supply — **\$205.50.**

## 2 A NEW TRANSMITTER

**HALLICRAFTERS HT-6 25 Watt.** New Phone and CW Transmitter. This sturdily built product puts you on the air in style, at low cost. Complete with tubes, less coils and crystal — **\$99.00.** With coils and crystal for one band — **\$108.75.**

**HALLICRAFTERS HT-1 50 Watt PHONE & CW TRANSMITTER.** A powerful job for the advanced Amateur. Complete with crystal, tubes and coils for three bands — **\$195.00.**

## 3 NEW EQUIPMENT

**ASTATIC D-104 Crystal MICROPHONE** — continues to be the most popular high quality Amateur mike — **\$13.23.**

**BLILEY VF-1 Variable Frequency CRYSTAL** — permits quick frequency shift — Each **\$6.60.**

**HALLICRAFTERS HT-7 FREQUENCY STANDARD.** Practically compulsory in every up-to-date Amateur station. A very useful device that helps you comply with FCC regulations. Entirely complete — **\$29.50.**

Popular Transmitting TUBES.

RCA 811 — **\$13.50** RCA 811 or 812 — **\$3.50**  
Taylor TZ40 — **\$3.50** H & K 54 — **\$6.75**  
Eimac 100TH — **\$13.50**

**Communication Measurements Lab PRESELECTOR.** A useful addition to any Amateur receiver. This well known acorn tube preselector uses the best of parts and is highly recommended. Complete with tube and coils for one band — **\$39.00.**

**James Millen HETROFIL.** One of the most important developments today. A very useful gadget for any Amateur — **\$3.50.**

## SUN GUARANTEES EARLY DELIVERY

All merchandise is brand New and in factory sealed cartons. Please get your orders in early. Thank You!

**Get Your Copy of the New Big STANCOR HAMANUAL**

Contains a large selection of Transmitters and Amplifiers, diagrams and useful information. Stop in or write in Today.

☆ MAIL ORDERS PROMPTLY FILLED



# RADIO CO.

212 Fulton Street, Dept. WT New York

Cable Address. SUNRADIO NEW YORK

W1EMG/1	W1EMG.....	7-A-1	90
W9LJL/9	W9JXD-W9GRA-W9UFA- W9VWU-W9LJL.....	7-A-1	90
W9YZX/9	W9WHS-W9YZX-W9KKX.....	10-A-1	90
W9RTU/8	W8RTU.....	48-C-1	73 RT
W1FFS/1	W1FFS.....	3-A-1	45
W1LXB/1	W1LXB-W1EAQ.....	3-A-1	45
W8UVA/8	W8UVA.....	3-A-1	45
W2FU/1	W2FU.....	23-C-1	41 RT
W9ZXA/9	W9ZXA.....	4-A-1	36
W8RXN/8	W8RXN.....	7-A-1	24 RT
W2BTC/2	W2BTC-W2LEB-W2LVN.....	1-A-1	18
W3BHE/3	W3BHE.....	1-B-1	12
W5HNV/5	W5HNV-W5BTH-W5BQD.....	1-B-1	12

## Correspondence

(Continued from page 84)

If those using crystal control stay where they are, and the new masses using electron-coupled oscillators do a little migrating, QRM will certainly decrease.

As an afterthought, you won't have to be a Sherlock Holmes in order to figure out a similar expedient if you are on ten meters, either c.w. or 'phone.

— Roy G. Walters, Jr., W6PNO

## LICKED BEFORE THEY START

Editor, QST:

Orchids to Carl Drumeller for his fine exposition of the principles and practice of good operating in the November issue, page 67.

But may I take exception to one of his suggestions? "If you have a low-powered transmitter and a good receiver, do not waste your time and cause interference by calling weak stations," says W9EHC. As a confirmed supporter of the low-power-transmitter and high-power-receiver theory, I feel it necessary to object! I suggest, on the contrary, that a ham get himself the very best receiver possible and then call anything he hears, low power or even flea power.

From considerable contact with amateurs around the country, I feel that the operator psychology represented in the quoted suggestion is primarily responsible for the pessimistic belief of low-power men that they can't get out. Licked before they start by the belief that they "can't," they never have a chance.

Knowing you have only 25 watts, do you pass up that European 80-meter DX you hear CQing? Not at all — go after him! (His card is now on our wall.) Or you hear a bunch of the boys swarming around the one Nevada station in the ORS Party; do you pass that up, too, because of low power? It would have cost a needed Nevada QSL for WAS if we had!

I don't believe at all it is a waste of time to make such calls, and certainly it isn't the low-power station that makes the QRM! No, forget the power. But plunk as much jack as you can scrape up in the receiver (you can't work what you can't hear) and then go after anything, anywhere. After all, the weak DX may also have a good receiver!

— A. L. Budlong, W1JFN

## FIRE INSURANCE

2 Hillside Court, Ann Arbor, Mich.

Editor, QST:

The Handbook and other amateur publications contain warnings about Underwriters' rules and local legislation affecting the validity of fire insurance policies covering premises on which amateur radio transmitters are located. From these it would appear that an amateur should learn the law in his case or else secure a rider to his policy assuring him of protection in the event of fire originating in his transmitting equipment or caused by lightning entering the house through his antenna.

As definite statements by local insurance agents or governments are hard to obtain and the regulations generally

# Where to buy it

A directory of suppliers who carry in stock the products of these dependable manufacturers.



**ALBANY, N. Y.** Uncle Dave's Radio Shack 356 Broadway

**ATLANTA, GEORGIA** 265 Peachtree Street  
Radio Wire Television Inc.

**BOSTON, MASS.** Radio Shack 167 Washington Street

**BOSTON, MASS.** 110 Federal Street  
Radio Wire Television Inc.

**BRONX, N. Y.** 542 East Fordham Rd.  
Radio Wire Television Inc.

**BUTLER, MISSOURI** 211-215 N. Main Street  
Henry Radio Shop

**CHICAGO, ILL.** 833 W. Jackson Blvd.  
Allied Radio Corp.

**CHICAGO, ILL.** 901-911 W. Jackson Blvd.  
Radio Wire Television Inc.

**CINCINNATI, OHIO** 1103 Vine Street  
United Radio, Inc.

**DETROIT, MICH.** 325 E. Jefferson Ave.  
Radio Specialties Co.

**DETROIT, MICHIGAN** 11800 Woodward Ave.  
Radio Specialties Co.

**HARTFORD, CONNECTICUT** 227 Asylum Street  
Radio Inspection Service Company

**HOUSTON, TEXAS** 4021 Huey Street  
R. C. Hall & L. F. Hall

**JAMAICA, L. I.** 90-08 166th Street  
Radio Wire Television Inc.

**KANSAS CITY, MO.** 1012 McGee Street  
Burstein-Applebee Company

**NEW YORK, N. Y.** Harrison Radio Co. 12 West Broadway

**NEW YORK, N. Y.** 100 Sixth Ave.  
Radio Wire Television Inc.

**NEWARK, N. J.** 24 Central Ave.  
Radio Wire Television Inc.

**READING, PENN.** 404 Walnut St.  
George D. Barbey Company

**SPRINGFIELD, MASS.** T. F. Cushing 349 Worthington St.

**WASHINGTON, D. C.** 938 F Street, N. W.  
Sun Radio & Service Supply Co.

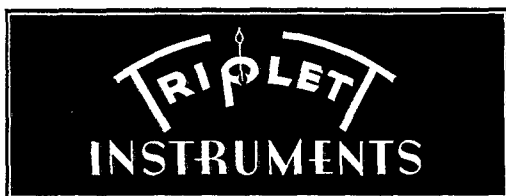

**ALBANY, N. Y.** Uncle Dave's Radio Shack 356 Broadway

**ATLANTA, GEORGIA** 265 Peachtree Street  
Radio Wire Television Inc.

**BOSTON, MASS.** Radio Shack 167 Washington Street

**BOSTON, MASS.** 110 Federal Street  
Radio Wire Television Inc.

**BRONX, N. Y.** 542 East Fordham Rd.  
Radio Wire Television Inc.

**BUTLER, MISSOURI** 211-215 N. Main Street  
Henry Radio Shop

**CHICAGO, ILLINOIS** 833 W. Jackson Blvd.  
Allied Radio Corp.

**CHICAGO, ILLINOIS** 25 North Franklin Street  
Electric & Radio Supply Co., Inc.

**CHICAGO, ILL.** 901-911 W. Jackson Blvd.  
Radio Wire Television Inc.

**CINCINNATI, OHIO** 1103 Vine Street  
United Radio, Inc.

**JAMAICA, L. I.** 90-08 166th Street  
Radio Wire Television Inc.

**LITTLE ROCK, ARKANSAS** 409 W. 3rd St.  
Beam Radio Company

**MINNEAPOLIS, MINNESOTA** 1124-26 Harmon Place  
Law Bonn Company

**MUSKOGEE, OKLAHOMA** 204 No. Twelfth Street  
Home Radio Mart

**NEW YORK, N. Y.** 100 Sixth Avenue  
Radio Wire Television Inc.

**NEWARK, N. J.** 24 Central Ave.  
Radio Wire Television Inc.

**READING, PENN.** George D. Barbey Co. 404 Walnut Street

**WASHINGTON, D. C.** 938 F Street, N. W.  
Sun Radio & Service Supply Co.

Listings on this page do not necessarily imply endorsement by QST of the dealers or of other equipment sold by them.

# Everything For Your ROTARY BEAM

For 10  
METERS  
**\$22.50**

Kit No. RB-2418  
containing two  
Double End Tele-  
scoping Corulite Ele-  
ments; Wood Frame  
Kit No. 2-W and  
Hand-operated Roto-  
mount No. BM-10 —  
all for \$22.50.

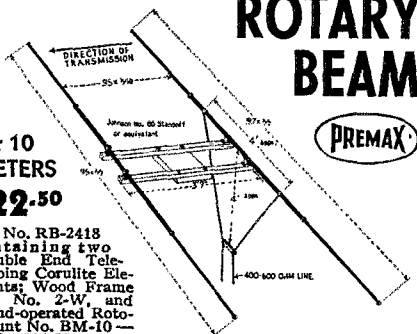

## READ WHAT A BRIDGEPORT HAM SAYS:

"Since installing your Premax Beam I have worked some real DX and heard more Asiatics than ever before on any antenna I ever had. I just wanted to tell you how pleased I am, and to tell you: 'You've Got Something There!'"

Premax Equipment includes all types of rotary beams, vertical radiators, wood towers, rotomounts — all fully described in Radio Bulletin H-3 which you can obtain FREE at your radio jobber's.

## PREMAX PRODUCTS

Division Chisholm-Ryder Co., Inc.  
4020 HIGHLAND AVE. NIAGARA FALLS, N. Y.

known seem to apply to commercial or obsolete amateur installations, amateurs pay little attention, to judge by the photographs of ideal stations in *QST*. (Low powered transmitters are not all surrounded by steel cabinets and barricades; and permanently grounded antennas are not provided with heavy knife-switches on huge stand-off insulators.)

If you examine your policy you will probably find no mention of amateur radio transmitters or antennas; and you are not specifically permitted nor forbidden under the policy to have them. You may however find the statement that, "unless otherwise provided by agreement in writing added hereto this company shall not be liable for loss or damage occurring . . . while the hazard is increased by any means within the control or knowledge of the insured." This is a very broad statement, and might be understood as referring to radio transmitters. It would seem that amateurs ought to get a rider or other written statement from the home office, to the effect that an amateur radio transmitter does not constitute an increased hazard in the meaning of the policy. Some agents are prepared to furnish this. Why not give them a chance?

— W. H. Worrell, W8SKW

## Strays

What war? We never heard of it.

From Blan, the Radio Man in New York, you can obtain a pair of moulded rubber "pants" to fit standard-size toggle switches. These pull on over the connecting wires and completely cover each terminal, preventing any possibility of poorly scraped connecting wires shorting and secretly closing the circuit.

If you operate portable or mobile, it might be a good idea to take along not only your license but also a copy of the F.C.C. Rules and Regulations. W8GDC avoided going to jail down in Kentucky by reading section 152.05 to a local sheriff who attempted to run him in because his home address only appeared on his license.

# AUDEL'S NEW RADIO -MANS GUIDE THE KEY

**FOR HOME STUDY**

**TO WHAT EVERY RADIOMAN SHOULD KNOW**

Information in a handy form covering modern Radio & Television in theory and practice. An entirely New Book that Points the Way to Success in Radio & Television — JUST OUT!

**772 PAGES — 400 DIAGRAMS & PHOTOS.** Featuring Authentic, Clear & Concise Radio Information. Physics of Sound — Radio Fundamentals — Ohm's Law — Batteries — Measuring Instruments — Power Supplies — Resistors — Inductors — Condensers — Transformers — Broadcasting — Radio Telephony — Vacuum Tubes — Radio Diagrams — Receiver Construction — Control Systems — Loud Speakers — Antennas — Phonograph Pickups — Public Address Systems — Aircraft & Marine Radio — Radio Compass — Radio Beacons — Automatic Alarm — Short Wave Principles — Coil Calculations — Electronic Television — Testing — Interference Suppression — Trouble Pointers — Underwriter's Standards — Tables — Review Questions & Answers — Ready Reference Index.

**\$4** Get this practical information in handy form for yourself — Fill in and mail coupon today.

**COMPLETE • PAY \$1 A MO.**

**HELP FOR YOU!**

**THEO. AUDEL & CO., 49 WEST 23rd STREET, NEW YORK**  
Mail AUDEL'S NEW RADIOMANS GUIDE for free examination. If O. K. I will send you \$1 in 7 days; then remit \$1 monthly until price of \$4 is paid. Otherwise, I will return it.

Name \_\_\_\_\_  
Address \_\_\_\_\_  
Occupation \_\_\_\_\_  
Reference \_\_\_\_\_ Q.S.T.

**ALWAYS  
BE  
CAREFUL**

\*\*\*

(A) Kill all transmitter circuits completely before touching anything behind the panel.

(B) Never wear 'phones while working on the transmitter.

(C) Never pull test arcs from transmitter tank circuits.

(D) Don't shoot trouble in a transmitter when tired or sleepy.

(E) When working on the transmitter, avoid bodily contact with metal racks or frames, radiators, damp floors or other grounded objects.

(F) Keep one hand in your pocket.

(G) Develop your own safety technique. Take time to be careful.

\*\*\*

**Death Is Permanent!**

# HAM-ADS

(1) Advertising shall pertain to radio and shall be of nature of interest to radio amateurs or experimenters in their pursuit of the art.

(2) No display of any character will be accepted, nor can any special typographical arrangement, such as all or part capital letters be used which would tend to make one advertisement stand out from the others.

(3) The Ham-Ad rate is 15¢ per word, except as noted in paragraph (6) below.

(4) Remittance in full must accompany copy. No cash or contract discount or agency commission will be allowed.

(5) Closing date for Ham-Ads is the 25th of the second month preceding publication date.

(6) A special rate of 7¢ per word will apply to advertising which, in our judgment, is obviously non-commercial in nature and is placed and signed by a member of the American Radio Relay League. Thus, advertising of bona fide surplus equipment owned, used and for sale by an individual or apparatus offered for exchange or advertising inquiring for special equipment, if by a member of the American Radio Relay League takes the 7¢ rate. An attempt to deal in apparatus in quantity for profit, even if by an individual, is commercial and all advertising by him takes the 15¢ rate. Provisions of paragraphs (1), (2), (4) and (5) apply to all advertising in this column regardless of which rate may apply.

Having made no investigation of the advertisers in the classified columns, the publishers of *QST* are unable to vouch for their integrity or for the grade or character of the products advertised.

**QUARTZ** — direct importers from Brazil of best quality pure quartz suitable for making piezo-electric crystals. Diamond Drill Carbon Co., 719 World Bldg., New York City.

**USED receivers.** Bargains. Cash only. No trades. Price list 3¢. W3DQ, Wilmington, Del.

**QSL's.** Free samples. Printer, Corwith, Iowa.

**CALLBOOKS** — Fall edition now on sale containing complete up-to-date list of radio hams throughout entire world. Also world prefix map, press schedules and new time conversion chart. Single copies \$1.25. Canada and foreign \$1.35. Radio Amateur Call Book, 610 S. Dearborn, Chicago.

**CRYSTALS**, mounted, 80-160, \$1.25, V-cut 40, \$2.25. R9 Crystals, 338 Murray Ave., Arnold, Pa.

**QSL's, SWL's.** 100 — 3 color — 75¢. Lapco, 344 W. 39th, Indianapolis, Ind.

**MACAULO** code machines: low monthly rental 50,000 words practice tapes. Write N. C. Ayres, 711 Boylston St., Boston, Mass. GRANite 7189-W.

**QSL's.** Maps. Cartoons. Free samples. Theodore Porcher, 7708 Navajo, Philadelphia, Pa.

**GENERAL Electric** dynamotors 24/750 volts 150 watts, \$15. Westinghouse 6-15 volt 500 watt aircraft with propellers, \$8. 27 1/2/350 volt, \$8. 500 cycle 500 watt generators with exciters, \$8. Henry Kienzie, 215 Hart Blvd., Staten Island, N. Y.

**QSL's**, all colors, cartoons, snappy service. Write for free samples today. W1BEF, 78 Warrenton, Springfield, Mass.

Stands for all types of microphones. Tri-ped, Jr. desk model, chrome or wrinkle, \$1.50. Ellis Lab., 189-Q W. Madison St., Chicago.

**MICROPHONES** — The best carbon microphones at anywhere near the price. Hand model \$5.75; stand model \$5; suspension model \$3.60; repairs. Ellis Lab., 189-T W. Madison St., Chicago.

**QSL's** — samples. Brownie, W3CJ1, 523 No. Tenth St., Allentown, Pa.

**CRYSTALS:** police, marine, aircraft, and amateur frequencies. Descriptive catalog. Ham Crystals, 1104 Lincoln Place, Brooklyn, N. Y.

**WHY** not get better deal? Used receiver list free. W6RA, Chidrad, 415 So. Dearborn St., Chicago.

**QSL's** — By W8NOS — 13 Swan St., Buffalo, N. Y.

1000 watt G.E. transformers 1100-2200-4400 volts each side c.t. Guaranteed. \$13.50. Dawson, 3740 Woodrow, Detroit, Mich.

**TELEPLEXES,** instructographs, omnigraphs bought, sold, traded. Ryan's, Hannibal, Mo.

**QSL's.** Samples. W9RUJ, Auburn, Neb.

**SELL** complete transmitter, 400 watt phone, CW completely enclosed, two cabinets, remote control. W2AEB.

**QSL's.** Samples. W6HBR Radio Press, P. O. Box 202, Clemenceau, Ariz.

**NEW** Hammarlund APC100 condensers, 60¢. Extraordinary bargains — power, audio transformers, chokes, gang condensers, dials, shield cans, parts, Radsur, Hyde, Pa.

**GOVERNMENT** contract surplus portable transmitters, direction finders, standard and special parts. Send postcard for special bargain list. Airplane & Marine Direction Finder Corp., Clearfield, Pa.

**CRYSTALS:** famous P.R., mounted in latest Alsimag 35 holders — 40, 80 meter PR-X, 160 meter PR-Z, \$3; 40, 80 meter PR-Z (low drift), \$3.50; 20-meter PR-20, \$4.50; unconditionally guaranteed. Immediate shipment. Wholesale Radio Labs., Council Bluffs, Iowa, W9GFQ.

**MIMS** — Bassett beams as low as \$10. down. Your own terms on parts, kits, as we finance our own paper, New Stancon kits in and wired reasonably. Two-color QSL cards with \$3. purchases only 25¢ 100. Get sample — write Leo W9GFQ.

**FELLOWS** — get the best bargains on reconditioned receivers and transmitters on your own terms. Specials galore on General transformers — modulation transformers, 100 watt \$1.95 and others. Write for free big list to Leo W9GFQ, Wholesale Radio Labs., Council Bluffs, Iowa.

**TAYLOR, RCA, Yaxley, National, I.R.C., Millen, Hallicrafter, Howard, Kenyon, Stancon kits, Gammatron, Eimac, Triplett, amateur supplies.** Bridgeport, New Haven, and Hartford, Connecticut. Hatry & Young.

**FRITZ'S QSL's** are tops. 455 Mason, Joliet, Ill.

75 watt phone — CW transmitter. Write for specifications. W9OTL.

**HALLICRAFTER SX18** and S meter, \$55. John Aufiero, 446 Crown, Brooklyn, N. Y.

**QSL's, QSL's, SWL's,** America's finest. Free samples. W8DED, Holland, Mich. (Stationery?)

**WANTED:** old spark equip: transformers, quenched-gaps, synchronous rectifiers, mica conds., etc. Pae state price first letter. W5KD, 215 N. W. 19 St., Oklahoma City, Okla.

**SECURE** your amateur or commercial license easily and quickly. Our illustrated method of instruction brings you a license in record time. Semi-private classes — rates low — inquire about our home study courses. Radio License Training School, 728 S. Hill St., Los Angeles, Calif. VA8870.

**QSL's** — SWL's. Colorful, economical, free samples. Meade, 819 Wyandotte, Kansas City, Mo.

**BEST** buys — SX16 with speaker, \$60. Pair new 35T's, \$8. 250 watt all band phone and CW rig. 6L6G-809-100TH 56-pair, 56's-pair, 2A3's-pair, TZ40's; 4 power supplies, antenna throw-over relay, enclosed relay rack, complete with all coils, crystals, microphone, key, 6 meters — \$150. 15 watt 160 meter phone transmitter, worked all districts — \$20. Few transformers, chokes, tubes, etc., cheap. W3HYP, Hotel Dudley, Atlantic City, N. J.

**SELL** used Gross CP-55 100 watt CW transmitter. W1KUM.

**WANTED:** late model used communication receiver, good condition, bargain. W51BN, Wickes, Ark.

**WANTED:** used xmt, medium or low power, 25 cycle power supply preferred though not essential. W9FTF, Hamilton, Ill.

**SELL:** 807, 40 watt xmitter complete, \$20. W2HFM.

**HALLICRAFTER SX-24**, used few weeks, perfect, factory guarantee. \$59. W2EXR.

**CRYSTALS:** police, marine, aircraft, broadcast, amateur. Literature upon request. C-W Mfg. Co., 1170 Esperanza, Los Angeles.

**KNOW** your code? We can teach you. Private or class lessons. Radio License Training School, 728 S. Hill St., Los Angeles.

**WANT:** ham receiver any condition. Connor, Box 21, Sta. A, Boston, Mass.

**QSL's.** Highest quality. Latest samples. Maleco, 1805 St. Johns Place, Brooklyn, N. Y.

**CRYSTALS** in plug-in heat dissipating holders. Guaranteed good oscillators. 160M — 80M, \$1.25. (No Y cuts.) 40X, \$1.65. 30M vari-frequency (5 kilocycle variance) complete, \$2.95. State frequency desired. C.O.D.'s accepted. Pacific Crystals, 1042 S. Hicks, Los Angeles.

**BEAM** builders — \$39. buys rugged steel frame, 2" hollow shaft, quiet motored, built-in indicator, tip-down head, rotator. Our tapered telescoping aluminum elements are light, strong, non-rusting, shed ice. Complete 3, 4 element beams, Bassett feeder cable; handbooks 25¢. Get our bulletins, photos. Rotary Array Service, W8ML.

**QSO** crystals — tested — at \$1.95, 40-X, \$2.50. W8OUE, Paul Byers, Indiana, Pa.

**QSL's** of distinction — samples. W2AEY, 338 Elmora, Elizabeth, N. J.

**WANTED:** 300 watt 110 volt a.c. gas driven generator. Trade for or buy. W2KAP.

**BARGAIN:** W8KML's 250 watt phone — CW 10 to 160 meter transmitter; complete — efficient, latest type tubes, less than cost of parts — \$125. W8KML.

**CRYSTAL** ovens adaptable any round holder 2 X 1 inches or less. Specify 6.3 or 2.5 voltage. \$1.50 postpaid. Sodaro Mfg., 115 N. Lockwood, Chicago.

**GOES** over like a KW. Your call in gold-filled wire on chain tieclip. A wov of a gift. One dollar prepaid. W9SZB.

SELLING, Meissner shifter, NC100, fone transmitter. W8QXU. FBXA 160 — 80 — 40 — 20 — B coils, National power supply, magnetic speaker. Best offer. W8EQW.

BEST place to get amateur receivers is W9ARA. Best trades, best terms (financed by myself), ten day trial. Prompt shipment from world's largest stock. Shipment from factory if preferred. Write me about your wishes. I will help you get the best receiver. Complete stock of all amateur transmitters, antennas, kits, parts too. W9ARA, Butler, Mo.

RECONDITIONED guaranteed amateur receivers and transmitters. Nearly all models cheap. Ten days free trial. During December many models at extra 25% discount from regular prices. Terms, List free. W9ARA.

CRYSTALS: Who stands behind the crystal you buy? Every T9 crystal is backed by a positive guarantee of complete satisfaction. T9 fracture-resisting X cuts; 40 and 80 meter bands, \$1.60, approximate frequency; \$2., exact; \$3., exact, mounted. T9 ceramic holders, \$1. Prices postpaid. C.O.D.'s accepted. Don't let our prices fool you — the quality is there. Send for folder on commercial crystals. Sold by these and other reputable dealers: Frank Anzalone, 375 W. 46th, N. Y. C.; Radio Doc, 721 S. Main, Los Angeles, Calif; Henry Radio Shop, Butler, Mo.; J. Edward Gantz, Lebanon, Pa.; Pembleton Labs., Ft. Wayne, Ind.; Hieronymus Radio, 88-34 209th, Queens Village, N. Y.; Distribuidora Mexicana de Radios, Monterrey, Mexico; and Eidson's, Temple, Texas.

DOUGLAS universal modulation transformers, 50 watts audio, \$4.95 pair, 100 watts audio, \$7.75 pair, postpaid in U. S. One year guarantee. Write W9IXR, Rice Lake, Wis.

MUST sell — 250 watt phone transmitter complete, 100 watt CW transmitter and 100 watt phone transmitter. W5HXC, Blackwell, Okla.

W9KEH, Joe Koese, announces purchase of one-third interest in Van Sickle Radio Co., 1113 Pine St., St. Louis, Mo.

SACRIFICE perfect NC81X for highest offer. Husky 800 watt 80 meter CW transmitter complete for \$100. Modified National SW5, coils, power supply for \$15. 5 meter push-pull RCA 834 amplifier and push-push 807 doubler, four Westons, Cardwells, for \$25. Equipment in Baltimore, Md. Joseph Brian, 418 Claremont Avenue, Westmount, P. Q., Canada.

MOTOR generator set. Ten horsepower GE three-phase motor. 2500 volt 2 amp. 2 unit Esco generator. WJAG, Norfolk, Neb.

SELL 32 v. d.c. 110 a.c. 1 amp., \$16. D. J. Thies, Arlington, Minn.

SELL 150 watt 10 to 160 phone, CW rig and 10 rotary, \$100. W2JH.

M & H precision frequency meter for sale, \$19. Sterling Kuhlmeier, Proctor, Minn.

CALLS: 100,000 thanks for the past year's business. Am now able to give even better service. 2½ inch polished aluminum calls, red enamel edging — for car or studio — \$1.50 each, \$2.25 pair; 1½ inch, \$1. each, \$1.50 pair. Money back if not entirely satisfied. The gift that lasts for years. E. Bailey, W. Newton, Pa.

COLLINS high fidelity 300BA, CW — phone, 400 w. 10 through 80 — complete, two cabinets, 7C speech amplifier, mike. Cost \$1,750 — for quick sale, will sacrifice for \$850. W5DLC, 4329 Normandy, Dallas, Texas.

WANTED: modern receiver, cash. Write W2ARE.

WANTED: Used communication receivers of standard makes. Or attractive trade-in prices offered. Terms to Conn. hams. Hatry & Young, Hartford.

1938 Sky Challenger and Utah Jr., perfect condition. Will sell one or both. \$50. A. Montgomery, Meriden, N. H.

GOODBYE batteries. Write for dope on new Forsyth variable bias supply. Real regulation. Forsyth Equipment Co., Box 191, Jacksonville, Fla.

SEE: amateur receivers, tubes, parts, crystals, mikes at any of three friendly Connecticut stores — Hatry & Young, Hartford, New Haven, Bridgeport.

WANTED: nearly new kilowatt transmitter or parts, VM5-tank condenser, HDVL swinging link coils, RME-69 DB20, Eimacs. Box 392, Beloit, Wis.

W3BBB selling out. Complete station 1 kw. CW and fone transmitter, Hammarlund Pro receiver, \$300, cash. No parts separately, entire station must go. Write for details. L. W. Haeseler, 6717 Rogers Ave., Merchantville, N. J.

RACKS — six foot, seventy pounds — amateur panel notching. \$8.25 f.o.b. C. Schaaf, 4741 Byron St., Chicago.

RADIO kits — \$3.95 up. Complete. Single band; all-wave; 5-10 tubes. Radio and parts catalog — free. McGee Radio, P-2035, K. C., Mo.

TRANSMITTER, rack and panel 200 watts, phone PPTZ-40 final. TZ-40 modulators complete speech, mike 10 and 20 meters, \$145. Ross superhet receiver 80-160 meters only \$25. W3ASQ.

CONNECTICUT hams: our Bridgeport, Hartford, and New Haven stores need used communications receivers, trade now. Time payments, too. Hatry & Young.

# LOW COST STEEL ANTENNA TOWER

Used and Endorsed by  
FEDERAL, STATE, COUNTY, CITY GOV'TS.,  
FORESTRY, HIGHWAY PATROLS  
and HAMS everywhere!

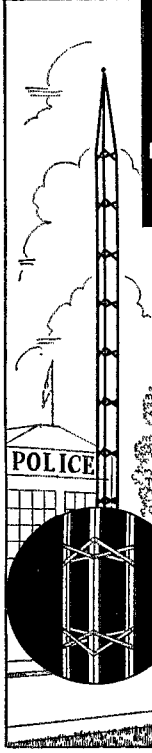

## ONLY 60¢ PER FOOT Complete!

This remarkable low price is possible only because we produce many thousands of these towers each year for use with our Wincharger. Price includes necessary guy wires and tower sections of 10 or 20 ft. lengths with 5 ft. tapered stub top.

### LIGHT, STURDY, RIGID

Thousands in use as vertical radiators and horizontal antenna supports. Scientifically braced. No points of undue strain. Both vertical angles and cross braces now hot dip galvanized. Quickly and easily erected to heights of from 25 ft. to 200 ft.

### READ U. S. FORESTRY LETTER!

"Your tower was installed on Signal Peak, a Lookout Station on the Yakima Indian Reservation, at an elevation of 5,111 ft. above sea level. We have found the Wincharger tower 100% satisfactory and it has stood up under 70 mile winds, snow and ice which are severe at almost a mile up from sea level." Thomas L. Carter, Forest Supervisor, Office of Indian Affairs, U. S. Department of the Interior, Toppensish, Wash.

**COMMERCIAL BROADCASTERS:**  
Write for complete information on new type heavy towers designed for heights up to 300 feet.

**WINCHARGER CORPORATION**  
Sioux City, Iowa

## RADIO ENGINEERING



RCA Institutes offer an intensive course of high standard embracing all phases of Radio and Television. Practical training with modern equipment at New York and Chicago schools. Also specialized courses and Home Study Courses under "No obligation" plan.

Illustrated Catalog on request

**RCA INSTITUTES, INC.** Dept. ST-39

A Radio Corporation of America Service  
75 Varick St., New York 1154 Merchandise Mart, Chicago

# PRICES REDUCED

## BLILEY

TYPE VFI  
VARIABLE FREQUENCY

## CRYSTAL UNITS

40-80 METERS

Now \$6.60

Get your copy of Circular A7  
from your Bliley Distributor

# Your Nearby Dealer Is Your Best Friend

Your nearby dealer is entitled to your patronage. He is equipped with a knowledge and understanding of amateur radio. He is your logical source of advice and counsel on what equipment you should buy. His stock is complete. He can supply your needs without delay. His prices are fair and consistent with the high quality of the goods he carries. He is responsible to you and interested in you.

One of these dealers is probably in your city—Patronize him!

<p><b>ATLANTA, GEORGIA</b> Radio Wire Television Inc. 265 Peachtree Street "The World's Largest Radio Supply House"</p>	<p><b>JAMAICA, L. I., NEW YORK</b> Radio Wire Television Inc. 90-08 166th Street (Merrick Road) "The World's Largest Radio Supply House"</p>
<p><b>BALTIMORE, MARYLAND</b> Radio Electric Service Co. 3 N. Howard St. Everything for the amateur</p>	<p><b>NEWARK, N. J.</b> Radio Wire Television Inc. 24 Central Avenue "The World's Largest Radio Supply House"</p>
<p><b>BOSTON, MASS.</b> Radio Wire Television Inc. 110 Federal Street "The World's Largest Radio Supply House"</p>	<p><b>NEW YORK, N. Y.</b> Radio Wire Television Inc. 100 Sixth Avenue "The World's Largest Radio Supply House"</p>
<p><b>BRONX, NEW YORK</b> Radio Wire Television Inc. 542 East Fordham Road "The World's Largest Radio Supply House"</p>	<p><b>NEW YORK, N. Y.</b> Harrison Radio Company 12 West Broadway Harrison Has It! Phone WOrth 2-6276 for information or rush service</p>
<p><b>BUFFALO, NEW YORK</b> Radio Equipment Corp. 326 Elm Street W8PMC and WBNE — Ham, service and sound equipment</p>	<p><b>PHILADELPHIA, PENNSYLVANIA</b> Eugene G. Wile 10 S. Tenth Street Complete Stock of Quality Merchandise</p>
<p><b>BUFFALO, NEW YORK</b> Dymac Radio 1531 Main Street — Cor. Ferry Open Evenings GA. 0252</p>	<p><b>PROVIDENCE, RHODE ISLAND</b> W. H. Edwards Company 85 Broadway National, Hammarlund, Hallicrafter, Thorderson, Taylor, RCA</p>
<p><b>HOUSTON, TEXAS</b> R. C. &amp; L. F. Hall 4021 Huey Street (W 9-2713) "Specialists in Amateur Supplies"</p>	<p><b>RICHMOND, VIRGINIA</b> The Arnold Company Broad at Harrison St. W3EQQ — "The Virginia Ham Headquarters" — W3FBL</p>

YOU CAN BE SURE  
WHEN YOU BUY FROM

**QST**

**ADVERTISERS**

“Advertising for *QST* is accepted only from firms who, in the publisher’s opinion, are of established integrity and whose products secure the approval of the technical staff of the American Radio Relay League.”

*Quoted from QST’s advertising rate card.*

*Every conceivable need of a radio amateur can be supplied by the advertisers in QST. And you will know the product has the approval of the League’s technical staff*

*Index to Advertisers*

Abbott Instrument, Inc.	82
Aerovox Corp.	94
American Radio Institute.	113
Astatic Microphone Laboratory, Inc.	105
Audel & Company, Theo.	118
Barker & Williamson	68
Bliley Electric Company	103, 120
Brazilian Trading Company	111
Burgess Battery Company	Insert
Candler System Company	102
Capitol Radio Engineering Institute.	106
Cardwell Mfg. Corp., Allen D.	70
Carrier Microphone Company	98
Centralab	72
Collins Radio Company	Cov. 2
Cornell-Dubilier Electric Corp.	69
Coto-Coil Company, Inc.	110
Dodge’s Institute	114
Elcor, Inc.	103
Eitel-McCullough, Inc.	67
Electro-Voice Mfg. Company	86
Gardiner-Levering Company	92
General Electric Company	115
General Radio Company	111
Gordon Specialties Company	115
Gross Radio, Inc.	102
Guthman & Company, Inc., Edwin I.	92
Hallcrafters, Inc., The	1, 2
Ham Picture Man, The	103
Hammarlund Mfg. Company, Inc.	4, 5, 109
Harvey Radio Company	108
Harvey Radio Laboratories	75
Heintz & Kaufman, Ltd.	109
Henry Radio Shop	91
Hipower Crystal Company	110
Howard Radio Company	87
Hytronic Laboratories	81
Instructograph Company	111
International Resistance Company	7
Jappe Company, H.	113
Johnson Company, E. F.	79
Kato Engineering Company	99
Ken-Rad Tube & Lamp Corp.	103
Kenyon Transformer Company, Inc.	74
Mallory & Company, Inc., P. R.	66
Massachusetts Radio School	105
Midland Television, Inc.	88
Millen Mfg. Company, Inc., James	Insert
Mims Radio Company	107
Monitor Piezo Products Company	76
National Company, Inc.	65, 73, 99, Cov. 3
New York YMCA Schools	105
Newark Electric Company	89
Nilson Radio School	112
Ohmite Mfg. Company	112
Port Arthur College	90
Precision Apparatus Corp.	80
Precision Piezo Service	109
Premax Products	118
RCA Institutes, Inc.	120
RCA Mfg. Company, Inc.	114, Cov. 4
Radio City Products	90
Radio Mfg. Engineers, Inc.	123
Radio Shack, The	93, 104
Radio Transceiver Laboratories	105
Scientific Radio Service	94
Shuler Supply Company	104
Sickles Company, F. W.	99
Solar Mfg. Corp.	93
Speer Carbon Company	85
Sprague Products Company	Insert
Standard Transformer Corp.	83
Sun Radio Company	116
Taylor Tubes, Inc.	77
Teleplex Company	94
Terminal Radio Corp.	113
Thordarson Electric Mfg. Company	71
Triplett Elec. Instrument Company, Inc.	78
Turner Company	107
United Transformer Corp.	124
Valpey Crystals, The	105
Vibroplex Company, Inc., The	114
Wholesale Radio Laboratories	93
Wincharger Corp.	120
Varley	66



# RME RECEIVERS

Where does **YOUR** receiver stand?

Can you hear those elusive DX signals?  
Does QRM ruin your QSO's?

**CHECK ITS PERFORMANCE  
WITH THIS CONVENIENT CHART**

✓	(1) Can you spin the tuning dial by one finger with never a thought to backlash?
✓	(2) Can you use full audio output without worrying about loss of stability in the rest of the circuit?
✓	(3) Is your indicating meter sensitive to weak signals?
✓	(4) Does your automatic volume control respond to rapidly fluctuating signals?
✓	(5) Does your beat oscillator stay put when once set?
✓	(6) Can you hold signals on 10 meters or do they appear to have the jitters?
✓	(7) Does your receiver lack sensitivity or "aliveness" at certain points in the tuning range?
✓	(8) Is its appearance modern?

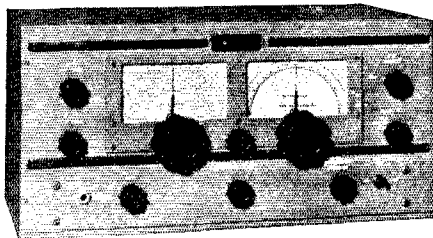

The RME-70, 550-32000 kc.

**IF YOUR PRESENT RECEIVER DOES NOT LIVE UP TO THESE QUALIFICATIONS**, if you have been experiencing difficulty holding signals long enough to complete a satisfactory QSO, or if your neighbor has been working the lion's share of DX, then you're not deriving the maximum of enjoyment from amateur radio.

Don't continue to follow **BEHIND** the rest of the gang; get up in the **FRONT** ranks with an RME receiver; then when those crisp winter nights come you'll be all set to tune those desired signals "right in the groove."

**OUR RME-70 AND HF-10 RECEIVERS QUALIFY 100%  
ON THE ABOVE CHART**

**T**HESE receivers are **ENGINEERED** to the last detail. They include all features which amateur and professional operators demand in a communication receiver. Why not investigate the smoothness of these instruments **TODAY**? Our Catalog 89, with full descriptions of these and other units, is waiting for you.

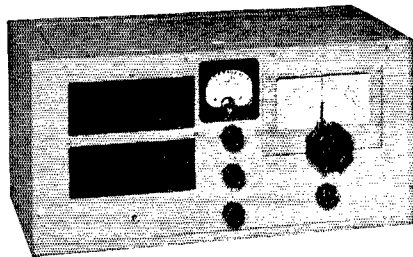

The HF-10, 5 and 10 Meters

**NOTE: THERE ARE NO IMMEDIATE PRICE CHANGES CONTEMPLATED**

**RADIO MFG. ENGINEERS**

INCORPORATED

111 HARRISON STREET

PEORIA

ILLINOIS

# A Complete Line of UTC Transformers and Kits for Cathode Modulation

DOWN GOES THE COST OF RADIO TELEPHONY with UTC "HAM-PRICED" ITEMS

The new Jones Cathode Modulation System takes the high cost out of radio telephony. The combination of this new low cost modulation system and UTC low cost transformers sets a new high in transmitter value per dollar. Now you can get your voice on the air cheaply,



effectively, and in the most modern manner. Cathode Modulation enables you to use low power at negligible cost for modulator equipment . . . or high power at low cost. Unprecedented value in amplifier kits and power supplies for RF and AF units is effected through the use of UTC Special Series units.

New UTC CATHODE MODULATION TRANSFORMERS specified by FRANK C. JONES

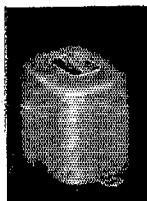

### up to 200 WATTS RF INPUT

Type CM-15 cathode modulation transformer, tapped secondary 300 to 2,000 ohms, will handle 15 watts audio.

Net Price **\$2.40**

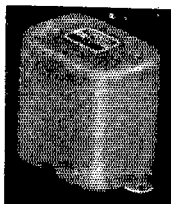

### up to 500 WATTS RF INPUT

Type CM-16 cathode modulation transformer with variable tapped secondary 300 to 2,000 ohms, audio power 35 watts.

Net Price **\$3.30**

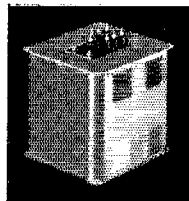

### up to 1 KW RF INPUT

Type CM-17 cathode modulation transformer, tapped secondary impedance 300 to 2,000 ohms, for modulating 1 KW plus RF input.

This transformer handles 100 watts audio power. Net Price **\$7.20**

Type CM-18 designed to work from 200 to 500 ohms upward of any standard amplifier into Cathode Modulation circuit. Secondary tap from 300 to 2,000 ohms. Will handle 15 watts audio. Net Price **\$2.40**

## New UTC CATHODE MODULATION TRANSMITTER KITS

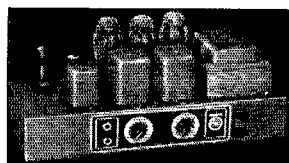

### S-25C

The S-25C audio amplifier has been designed specifically for the high power modulator field. This unit employs 6L6 tubes in the output

stage to obtain 25 watts of undistorted power, sufficient for modulating up to 500 watts RF input. The circuit is simple but highly efficient, effecting sufficient gain in three stages to operate from crystal or similar microphones. The tone and volume controls are mounted with the dual high impedance, high and low gain input jacks on one etched panel. A universal output plug is provided on the back of the chassis. The power supply is unusually rugged and employs a two-section filter for optimum regulation and hum reduction. The kit is supplied with CM-16 output transformer. The tubes required are one 6J7, one 6C5, two 6L6's and one 83. The S-25C kit is supplied completely mounted, ready to wire, less tubes, including all components, accessories, dust cover, etched plate, etc. Size 17" long x 7" wide x 9 1/2" high. Weight 32 pounds.

Net Price **\$30.00**

S-15C same as S-25C but 15 watts output (CM-15 output transformer) . . . . . Net Price **\$24.00**

### S-100CM

The S-100CM audio amplifier is an ideal inexpensive unit for amateur use. Four highly efficient stages are employed, permitting crystal, microphone input and 100 watt undistorted

output. Four 6L6 tubes are employed in the output stage for maximum tube economy and minimum plate potential. Fixed bias is employed on the output stage, permitting peak power handling ability appreciably over the normal rating. A modern etched panel sets off the attractive appearance of the gray crinkle cabinet. Tone and volume controls are provided. High impedance, high or low gain, dual input is arranged using standard jacks. A CM-17 modulation transformer is employed to effect maximum flexibility for cathode modulating any RF stage up to 1 KW. Tubes required are one 6J7, one 6C5, two 6F6's, four 6L6's, three 83's. The kit is supplied completely mounted, ready to wire, less tubes and dust cover, including all components, accessories, etched plate, etc. Size, less cabinet, 17" long x 12" wide x 9 1/4" high; with cabinet, 18" long x 13" wide x 12 1/2" high. Weight 59 pounds. Net Price **\$52.50**

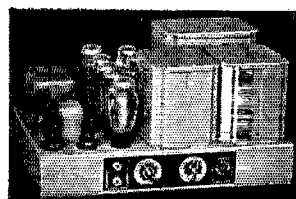

# UNITED TRANSFORMER CORP.

Write: COMMUNICATIONS DIV. ★ 150 VARICK ST. ★ NEW YORK, N. Y.  
EXPORT DIVISION: 100 VARICK STREET NEW YORK, N. Y. CABLES: "ARLAB"

## Index to Volume XXIII—1939

### AMATEUR RADIO STATIONS

Eight Years Before the Mike (W9BSP-UA).....	32, Feb.
W7DNP, W7FDL, W8WV, W9KEX, G5ZJ, W3AQN.....	60, Mar.
W6DVM, W3CVK, W5BRR, W9IQZ, VE3AGM, W8BQ, VO4A.....	43, July
VP2LC, ZD2H, CT3AB, VP6YB, SM7UC.....	61, Sept.

### ANTENNAS, FEEDERS AND MASTS

Anchoring Lattice Towers (Exp. Section).....	69, Sept.
Antenna Switching With Constant Loading.....	67, Jan.
Checking Beam Antennas with the S-Meter (Taylor).....	26, Apr.
The Coaxial Vertical Radiator (Long).....	42, Jan.
A Coupling System for the Close-Spaced Antenna-Director (Mobley).....	16, Apr.
A "Double-Barrelled" Antenna System (Swift).....	22, Apr.
The "Double-Pitchfork" Antenna (Breuer).....	40, July
Drip Wires for Antenna Feeders (Exp. Section).....	64, May
East and West from Old Sol (Owen).....	42, Oct.
Fashions in Antennas (Goodman).....	14, June
Feeding Rotatable Antennas for Continuous Rotation.....	39, Aug.
Feeding Vertical Antennas (Lynch).....	13, Jan.
A Few Feeder Considerations (Goodman).....	48, Sept.
Incorrect Use of 110-Volt Lamps to Terminate Rhombics (Exp. Section).....	62, Feb.
Another Inexpensive Seal for Coaxial Cables (Exp. Section).....	52, June
Inexpensive Tubing Seal for Coaxial Cables (Exp. Section).....	62, May
Inexpensive Low-Capacity Antenna Switch (Exp. Section).....	63, Apr.
Link Coupling for the Rotary Antenna (Burke).....	46, Nov.
Model Three-Element Beam Demonstrated at Pacific-Southwestern Division Convention (Bane).....	59, Nov.
More Thoughts on Effective Antennas (Lynch).....	11, Nov.
Poor Man's Rotary Beam (Southworth).....	47, Mar.
Putting the Antenna Back on the Pole (Exp. Section).....	62, Feb.
The "Q" Beam Antenna (Olander).....	24, Feb.
An R.F. Matching Network for General Use (Andrew).....	39, Oct.
Replacing Broken Antenna Halyards.....	60, Apr.
Rotatable Antenna Support from Automobile Parts (Exp. Section).....	62, Nov.
Rotating the Rotary (Williams).....	24, July
Simple Vertical Antennas (Ferrill).....	47, Feb.
Stacking Coaxial Antennas (Sanders).....	17, Nov.
A Three-Element Rotary Beam for \$16.61 (Meyer).....	26, May
The Two-Band Three-Element Rotary (Schroeder).....	16, Aug.

### ARMY AMATEUR RADIO SYSTEM

"Hand Keys Gone Pfft?".....	52, Apr.
Simulated Emergencies.....	43, June
Eighth Corps Area.....	53, Jan.
Ninth Corps Area.....	40, Mar.

### AWARDS

W.B.E. and B.E.R.T.A. Awards.....	48, June
W2JHB Wins 1938 Maxim Memorial Trophy.....	29, June
1938 Paley Trophy Awarded to W1DBS.....	23, July

### BOOK REVIEWS

Amateur Radio Handbook (R.S.G.B.).....	92, Feb.
Principles and Practices of Radio Servicing (Hicks).....	94, June
The Radio Manual (Sterling).....	39, Feb.

### COMMUNICATIONS DEPARTMENT

A.R.R.L. Headquarters Operators.....	76, Nov.
A.R.R.L. Official Observers.....	62, Aug.
A.R.R.L. Trunk Lines.....	82, Mar.
General Traffic Hour.....	72, Sept.
Guaranteed Traffic Service.....	75, Sept.
O.B.S. List.....	76, Oct.; 76, Nov.; 72, Dec.

S.C.M. Elections.....	80, Feb.; 82, Apr.; 68, June; 68, Aug.; 80, Oct.; 74, Dec.
-----------------------	--

### CONTESTS AND TESTS — ANNOUNCEMENTS

(See also, U.H.F. — Tests)

A.R.R.L. Copying Bee.....	34, Dec.
A.R.R.L.'s Eleventh Annual International DX Competition (Handy).....	20, Feb.
Canada-U. S. A. Contact Contest.....	35, Apr.
CT DX Contest.....	62, June
DJDC Contest.....	54, Aug.
Don't Miss the Tenth A.R.R.L. Sweepstakes (Handy).....	31, Nov.
Navy Day Receiving Competition.....	20, Oct.
Polish DX Contest.....	66, Apr.
Problem Contests (See, "How Would You Do It?").....	
2nd Annual "A.R.R.L." QSO Party.....	54, Jan.
Seventh A.R.R.L. Field Day Contest.....	28, 54, June
Third Annual South African DX Contest.....	92, Jan.
We Want a Safety Slogan.....	32, Mar.
1.75-Mc. Transatlantic Tests.....	90, Jan.
1.75-Mc. W.A.S. Party.....	52, Feb.

### CONTESTS AND TESTS — RESULTS

April O.R.S.-O.P.S. Parties.....	62, July
Copying Bee Results ('38).....	49, May
Field Day Results (Battley).....	35, Dec.
January O.R.S.-O.P.S. Parties.....	80, Apr.
July O.R.S.-O.P.S. Parties.....	66, Oct.
Navy Day — 1938.....	53, Feb.
October ('38) O.R.S.-O.P.S. Parties.....	84, Jan.
Results, South African DX Contest.....	80, Sept.
Results, 1939 DX Competition (Battley).....	45, Oct.
Scores, VE/W Contact Contest, 1939 (Leonard).....	40, Nov.
Second "A.R.R.L." QSO Party Results (Battley).....	44, July
"Switch to Safety".....	76, July
VK-ZL DX Contest ('38) Results.....	48, Aug.
1.75-Mc. Trans-Ocean Contacts.....	68, Feb.; 84, Mar.
1.75-Mc. W.A.S. Party Results.....	47, Aug.
1938 Sweepstakes Contest Results (Battley).....	53, Apr.
The 1939 Dog Fight (Goodman).....	12, May

### CONVENTIONS

Atlantic Division Convention.....	24, June
Central Division Convention.....	38, Aug.
Dakota Division Convention.....	36, May; 80, July
Hudson Division Convention.....	53, Sept.; 44, Oct.
Kansas State Convention.....	20, Oct.
Maritime Division Convention.....	41, Aug.
Massachusetts State Convention.....	114, Oct.
Midwest Division Convention.....	62, Oct.
New England Division Convention.....	40, May; 73, July
New Hampshire State Convention.....	26, Sept.
Northwestern Division Convention.....	22, July
Oklahoma State Convention.....	33, May
Oregon State Convention.....	21, Apr.
Pacific-Southwestern Divisions Convention.....	31, Aug.
Roanoke Division Convention.....	82, July
Rocky Mountain Division Convention.....	20, Aug.
South Dakota State Convention.....	53, Sept.
Vermont State Convention.....	62, Oct.
West Gulf Division Convention.....	41, Aug.
Wisconsin State Convention.....	41, Aug.

### EDITORIALS

About Intercepting.....	9, Nov.
"And Sudden Death".....	7, Feb.; 9, Aug.
A.R.R.L. Silver Anniversary.....	9, May
Blackout.....	7, Oct.
Farewell, S.F. System.....	8, Oct.
Freedom.....	9, Aug.
Frequency Measurement Regulations.....	9, July
Good Ol' Daze.....	17, Mar.
Home-Made Equipment.....	9, Sept.
Major Armstrong's Frequency Modulation.....	9, July
Maybe It's The Heat.....	9, Aug.
New U.H.F. Department.....	9, Dec.
The Only Good Indian.....	17, Mar.
Position Report.....	9, Nov.; 9, Dec.
QSL Bureaus.....	9, July
Summer Fun.....	9, July

U.H.F. Activities	9, Sept.
A 30-Kc. "Ham Band"	9, July
7-Mc. Broadcasting	9, Apr.
1938 in Review	7, Jan.
1939 B.C.L. Sets	9, June

## EMERGENCY AND RELIEF WORK

A.E.C. Hams Fight Forest Fire in the Black Hills (Russell)	84, Nov.
Australian Bush Fires	49, Aug.
Emergency Develops on F.D.I.	86, Sept.
Emergency Preparation Demonstrations	86, Jan.
F.C.C. Regulations on Emergency Communication	71, Feb.
Iowa Emergency Net	79, Mar.
Landmark Becomes Ham Emergency Center	45, Feb.
Missouri Emergency Net	68, Apr.
N. H. Emergency Mobilization	70, Feb.
So. Carolina Tornado	94, Jan.
Western Union to Collaborate with Amateurs (Handy)	45, June
West Virginia Flood Emergency	68, Apr.
Wisconsin-Minnesota Sleet Storm	88, Jan.

## EXPEDITIONS

Byrd Antarctic Expedition (De Soto)	11, Dec.
"Contender" Uses Amateur Frequencies in Gale! (Wallace)	82, Nov.
The Cruise of the "Pang-Jin" (Purcell)	18, Oct.
Ham at 30° Below — OX2QY (Sayre)	9, Jan.
Honolulu Bound (Wallace)	10, July
OQ5ZZ Calling "CQ USA" (Ruth)	29, Apr.
Rescue at 11,000 Miles (XF88AB)	15, Feb.
The Yacht "Contender" Comes in First (Wallace)	27, Sept.
Yacht "Haida" (WKDS)	78, Mar.

## FEATURES AND FICTION

Dixie Jones' Owl Juice	35, Apr.; 59, May; 24, June; 38, July; 41, Aug.
Entertaining Uncle Oscar	46, Aug.
"The Least of These My Brethren" (Castner)	21, May
A Long-Distance Receiving Set That Really Tunes (Beekley)	19, May
Tri-County Takes A Holiday (Griffin)	30, June
Twenty-Five Years Ago	11, May
"90-Plus" (Buffington)	39, June

## FREQUENCY CALIBRATION AND CONTROL

The Band-Edge Locator (Tibbetts)	27, Oct.
A Dual-Frequency Crystal Calibrator (Lennberg)	38, Jan.
Extending Freq-Meter Calibrations with the 100-Kc. Oscillator (Bunt)	46, Apr.
A Frequency-Checking Superhet (Griffin)	38, Apr.
Frequency Measurement and Regular Check (Robinson)	30, Mar.
A Simple Freqmeter-Monitor (Britt)	20, Nov.
Technical Aspects of the New Regs (Gramer)	33, Jan.
What's Your Crystal Frequency? (Lusk)	33, Feb.

## HAMDOM

Freeman (Amos) Gosden, W6QUT	23, Feb.
VK2HZ, VK2TI, VK6SA	59, Mar.

## HINTS AND KINKS

January, page 69	
An Oscillator Which Combines Many Features (Buffington)	
Trouble Going to Ten Meters? (Thomas)	
Emergency Grid Tank (Rogers)	
February, page 62	
Putting the Antenna Back on the Pole (Lowry)	
Incorrect Use of 110-Volt Lamps to Terminate Rhombics (Sherwood)	
Simplified Meter Switching (Smith)	
Receiver-Operated Relays (Eberhart)	
Use for Meter Boxes (Jette)	
March, page 62	
Push-Button Meter-Switching (Tulauskas)	
Current vs. Color of Pilot Bulbs (Sutter)	
Simple Checks on Gas Driven A.C. Generators (Nightingale)	
Elimination of Filament Transformer	
Overmodulation Indicator (Fulleoyler)	
Safety Switch for Power Supply (Taylor)	
April, page 63	
Inexpensive Low-Capacity Antenna Switch (Blaho)	
Neon-Tube Oscillation in Voltage-Regulated Supplies (Burnett)	
Double-Section Neutralizing Condenser (Bayne)	
New Method of Lowering Crystal Frequency (Hansen)	

May, page 62	
Sure-Fire Interlock (Mix)	
Improved Oscillator Screen-Grid Keying (Spittle)	
Three-Way Switch for Control (Mack)	
Automatic Stop for Band-Set Condensers in Superhets (Fleming)	
Inexpensive Tubing Seal for Coaxial Lines (Burton)	
Drip Wires for Antenna Feeders (Folts)	
June, page 50	
Polarity of Supply Line	
Shield for Exposed High-Voltage Chassis Terminals (Goldstone)	
Notes on Safe Construction (Beers)	
Variable Voltage Output with Uniform Regulation	
Three-Way Crystal Socket (Fowler)	
Still More on Neon-Bulb Regulated Power Supplies (Ford)	
Converting the Sky-Champion Receiver for S.S. Selectivity (Yingling)	
Another Inexpensive Seal for Coaxial Cables	

July, page 47	
Simple Noise Limiter for Push-Pull Audio (Mowery)	
Safe and Economical Transmitter Control Unit (Hamilton)	
Illumination for Meters (Greenbaum)	
August, page 50	
Kinks for Portable Transmitters (Walleze)	
Code Practice Machine (Branch)	
Cheap Relays for Keying and Other Uses (Long)	
Link Neutralizing for Low-Capacity Tubes (Buffington)	
September, page 69	
Inexpensive Homemade Crystal Mike (Melton)	
Anchoring Lattice Towers (Folts)	
Insulated Mounting for Rotatable Antenna Elements (Schults)	
Simple Line-Voltage Control	
October, page 60	
Keying E.C. Oscillators (Rees)	
Grounding Positive High Voltage for Safety (Fazakaa)	
Crystal Filter for 'Phone Work (Davis)	
Power Supply Kinks (Lawson)	
November, page 62	
Direction Finding With B.C. Portables (Sherwood)	
Rotatable Antenna Support from Automobile Parts (Schults)	
Measuring Radio Frequency Power Output (Ebel)	

## HOW WOULD YOU DO IT?

(Problem Contest)	
Antenna Switching	67, Jan.
Feeding Rotatable Antennas for Continuous Rotation	39, Aug.
Home-Made QSL's by Photographic Process	53, Oct.
Home-Made Receiver Coil-Shifting Mechanism	67, Sept.
Maintaining Constant Final Input	60, Feb.
Protection Against Damage by Lightning	55, May
Reducing Hazard in Neutralizing	46, June
Replacing Broken Antenna Halcyards	60, Apr.

## I.A.R.U. NEWS

63, Jan.; 65, Feb.; 65, Mar.; 59, Apr.; 60, May; 48, June; 48, Aug.; 65, Sept.; 53, Oct.; 60, Nov.; 53, Dec.	
Countries List	63, Jan.
Mexico	60, May
QSL Bureaus	59, Oct.
South Africa	63, Feb.

## INTERFERENCE

B.C.L. and the Amateur (Waller)	58, Feb.
B.C.L. QRM	70, Feb.
Electric-Razor Interference Filter	110, May
More About Amateur Interference with Broadcasting (Gustafson)	53, Sept.

## KEYING

Another Method of Keying with Controlled Rectifier Tubes (Goodman)	31, Jan.
Cheap Relays for Keying and Other Uses (Exp. Section)	51, Aug.
Improved Oscillator Screen-Grid Keying (Exp. Section)	62, May
Keying E.C. Oscillators (Exp. Section)	60, Oct.
New Keying Device	122, May

## METERS AND MEASUREMENTS

Checking Beam Antennas with the S-Meter (Taylor)	26, Apr.
Coil Chart for Quick Reference (Gallagher)	28, Nov.
Current vs. Color of Pilot Bulbs (Exp. Section)	62, Mar.
Illumination for Meters (Exp. Section)	48, July
Measuring Radio Frequency Power Output (Exp. Section)	63, Nov.
A New Idea in V.T. Voltmeter Design (Pollard)	56, Mar.

A New Method of Measuring A.C. Voltages (Wachtman).....	49, Nov.
The Oscilloscope Shows—What? (Ferrill).....	30, Oct.
Pussy-Button Meter-Switching (Exp. Section).....	62, Mar.
Simplified Meter Switching (Exp. Section).....	63, Feb.
Use for Meter Boxes (Exp. Section).....	64, Feb.
A 6H6 A.C.—D.C. Voltmeter (Carter).....	48, Apr.

### MISCELLANEOUS

Amateur Radio at the Fairs.....	25, May; 23, June; 26, July; 84, Sept.
Calls Heard.....	8, Jan.
Code-Practice Machine (Exp. Section).....	51, Aug.
East and West from Old Sol (Owen).....	42, Oct.
Hamfesters' Picnic 1939.....	114, Nov.
A Homemade Exponential Horn (Coombs).....	20, Dec.
Homemade QSL's by Photographic Process.....	56, Oct.
Modern Radio Course Resumed.....	23, Dec.
An Old-Timer Builds a Broadcast Receiver.....	46, May

### NAVAL COMMUNICATIONS RESERVE

First Naval District.....	46, Feb.
Fourth Naval District.....	48, Apr.
Sixth Naval District.....	30, Nov.
Seventh Naval District.....	21, Aug.
Ninth Naval District.....	44, June
Eleventh Naval District.....	46, Mar.
Twelfth Naval District.....	60, Jan.
Thirteenth Naval District.....	52, May
Navy Day—1938 (Results).....	53, Feb.
Navy Day Receiving Competition.....	20, Oct.

### OBITUARY

Silent Keys... 63, Jan.; 98, Feb.; 64, Mar.; 17, Apr.;	96, May;
24, June; 86, July; 18, Sept.; 44, Oct.;	19, Nov.
Henry E. Benner, W6NVE.....	38, Aug.
Clyde Gardner, W6KOT.....	48, Nov.
Dr. Arthur E. Kennelly.....	31, Aug.
Philip E. Murray, W9VYU.....	31, Feb.
John C. Stadler, VE2AP.....	33, May; 24, Dec.

### OPERATING PRACTICES

(See also, "Safety Technique")

ARL Check (Handy).....	68, Mar.
Duplex.....	25, Apr.
DX Bookkeeping (Warner).....	65, Oct.
Flood Traffic (Tappan).....	73, Jan.
Harmonics (Handy).....	50, July
"How's Your QSO Personality? (Starek).....	61, Dec.
The "How" of a Good Pist (Camden).....	67, Apr.
How to Become a 1st Class "Lid" (Schnell).....	51, July
How to Operate Well (Drummeller).....	67, Nov.
Mumbblings of a "Phone Ham (Mitchell).....	69, Mar.
One-Track Amateurs (Espy).....	55, Aug.
Operating ECO's (Handy).....	66, Apr.;
Operating Pointers (Muncey).....	57, June
"Please QRS" (Buck).....	69, Feb.
Reduce QRM—Use Break-In (Cushing).....	73, Sept.
A Safe Safety Program (Ward).....	67, May
Signing Logs.....	24, Apr.
Sportsmanship (Handy).....	68, Feb.
Stop Thief! (Paige).....	55, June
Use New Punctuation Symbols.....	70, Feb.

### POWER SUPPLIES

(See also, "Safety Technique")

Neon-Tube Oscillation in Voltage Regulated Supplies (Exp. Section).....	63, Apr.
Power Supply Kinks (Exp. Section).....	61, Oct.
Safety Devices for Amateur Transmitters (Grammer).....	42, Apr.
Safety Switch for Power Supplies (Exp. Section).....	64, Mar.
Safety Technique in Transmitter Construction (Grammer).....	19, Mar.
Simple Checks on Gas-Driven A.C. Generators (Exp. Section).....	63, Mar.
Simple Line-Voltage Control (Exp. Section).....	70, Sept.
Still More on Neon-Bulb Regulated Power Supplies (Exp. Section).....	51, June
Variable Voltage Output with Uniform Regulation (Exp. Section).....	51, June

### RADIOTELEPHONY

(See also, "Safety Technique")

Cathode Modulation (Jones and Edmonds).....	23, Nov.
More on Cathode Modulation (Edmonds).....	52, Dec.
Better "Phone Operation Without Splatter (Bain).....	43, Sept.
Break-In Telephony with Carrier Suppression (Kaplan).....	36, Feb.
High-Efficiency Grid Modulation in a Portable 14-Mc. "Phone Transmitter (Denton).....	33, July
Increased Output with Grid-Bias Modulation (McCullough).....	40, Sept.

Inexpensive Home-Made Crystal Mike (Exp. Section).....	69, Sept.
Low-Pass Filters for Time-Delay Circuits (Owens).....	19, Aug.
A Peak-Limiting Amplifier for Amateur Use (MacFarland).....	36, Apr.
"Phone "Splatter" (Fortune).....	23, Jan.
Pointers on Design and Adjustment of High-Efficiency Grid-Modulated Amplifiers (Winkler).....	34, Nov.
Volume Compression Simplified (Lamb).....	58, May
Wave-Shape Plots for Checking Amplifier Distortion (Grammer).....	50, May
A Wide-Range Audio Amplifier (Ferrill).....	24, Jan.

### RECEIVING — GENERAL

Automatic Stop for Band-Set Condensers (Exp. Section).....	62, May
Converting the Sky Champion Receiver for S.S. Selectivity (Exp. Section).....	52, June
Crystal Filter for "Phone Work (Exp. Section).....	61, Oct.
Direction-Finding with B.C. Portables (Exp. Section).....	62, Nov.
Diversity with What You Have (Taylor).....	56, Sept.
Factors Influencing the "Q" of R.F. Coils in Amateur Band Receivers (Pollack).....	54, Feb.
Hetrofil—An Aid to Selectivity (Woodward).....	11, Sept.
Home-Made Receiver Coil-Shifting Mechanism.....	67, Sept.
The Infinite Impedance Detector (Goodman).....	21, Oct.
Input Resistance of R.F. Receiving Tubes (Grammer).....	41, May
Preselection Pointers (Griffin).....	30, May
The Series-Valve Noise Limiter (Bacon).....	15, Oct.
A Signal-Metering Valve (Talen).....	64, Jan.
Simple Noise Limiter for Push-Pull Audio (Exp. Section).....	47, July
Stepping Up Receiver Performance (Veatch and Kahle).....	12, July
The 1852 as a Mixer (Grammer).....	37, June

### RECEIVERS — REGENERATIVE

A Hurricane Emergency Receiver (Smith).....	48, Apr.
Selectivity with the 2-Tube Regenerative Receiver (Sutter).....	36, Jan.

### RECEIVERS — SUPERHETERODYNE

A DX Man's Superhet (Caird).....	11, Apr.
A Four-Tube Superhet (Goodman).....	16, Dec.
A Modern Band-Switching Superhet (Parnenter).....	23, Mar.
A Portable Station for A.C. or Battery Operation (Steiner).....	34, Mar.
Preselection Pointers (Griffin).....	30, May
A QST-Size Super (Alexander).....	20, June
A Simple 5-, 10- and 20-Meter Converter for Home or Car (Chapin).....	44, May
A Six-Tube Battery-Operated Single-Signal Superheterodyne (Mix).....	9, Feb.
Stepping Up Receiver Performance (Veatch and Kahle).....	12, July

### REGULATIONS AND LEGISLATION

The Cairo Regs Go into Effect (Warner).....	30, Jan.
Chimes Prohibited.....	25, May
F.C.C. Disciplinary Actions.....	63, June; 57, Aug.; 74, Sept.; 67, Oct.
F.C.C. Regulations on Emergency Communication (Handy).....	71, Feb.
License Warning.....	24, May
More Examination Points.....	18, Jan.
New Radio Legislation?.....	24, Apr.
New U.H.F. Allocations.....	24, May
Record Players.....	25, May
Technical Aspects of the New Regs (Grammer).....	33, Jan.

### SAFETY TECHNIQUE

"... And Sudden Death" (Editorials).....	7, Feb.; 9, Aug.
Grounding Positive High Voltage for Safety (Exp. Section).....	60, Oct.
Notes on Safer Construction (Exp. Section).....	50, June
"The Only Good Indian..." (Editorial).....	17, Mar.
Polarity of Supply Line (Exp. Section).....	50, June
Protection Against Damage by Lightning.....	55, May
Resuscitation from Electrical Shock (DeSoto).....	16, Feb.
Safe and Economical Transmitter Control Unit (Exp. Section).....	47, July
"Safety" Becomes a Watchword (DeSoto).....	47, May
Safety Devices for Amateur Transmitters (Grammer).....	42, Apr.
A Safety Kilowatt Transmitter (Bishop).....	42, Nov.
Safety Switch for Power Supplies (Exp. Section).....	64, Mar.
Safety Technique in Transmitter Operation and Construction (Grammer).....	19, Mar.

Shield for Exposed High-Voltage Chassis Terminals (Exp. Section).....	50, June
Sure-Fire Interlock (Exp. Section).....	62, May
"Switch to Safety".....	76, July

**"SPLATTER"**

14, Feb.; 18, Mar.; 10, Apr.; 10, June; 10, Aug.; 10, Sept.; 17, Oct.; 10, Nov.; 10, Dec.
---

**TELEVISION**

Construction and Alignment of the Television Receiver (Shumard).....	45, Jan.
An Electrostatic-Deflection Kinescope Unit for the Television Receiver (Sherman).....	52, Mar.
Using Electro-Magnetic Deflection Cathode-Ray Tubes in the Television Receiver (Sherman).....	40, Feb.

**TRANSMITTING — GENERAL**

(See also, "Safety Technique")

"The Compleat Experimenter" (Bumbaugh).....	35, Oct.
Double-Section Neutralizing Condenser (Exp. Section).....	64, Apr.
Five Bands Without Changing Coils (Ferrill).....	43, Dec.
Frequency-Modulation Fundamentals (Noble).....	11, Aug.
How to Figure Grid-Bias Requirements (Selvidge).....	24, Oct.
How to Lay Out a Metal Chassis (Mix).....	53, May
Link Neutralizing for Low-Capacity Tubes (Exp. Section).....	50, Aug.
Maintaining Constant Final Input.....	60, Feb.
New Ideas for Transmitters (Ferrill).....	34, Sept.
Polystyrene: Its Electrical and Mechanical Characteristics (Riddle).....	32, Aug.
Reducing Hazards in Neutralizing.....	46, June
Safe and Economical Transmitter Control Unit (Exp. Section).....	42, July
Safety Technique in Transmitting Operation and Construction (Gramer).....	19, Mar.
A Single-Control Wide-Range Tank Circuit (Ferrill).....	38, Nov.

**TRANSMITTING — CRYSTAL AND**

**E.C.O.**

An Answer to the E.C.O. Problem (Perrine).....	14, Sept.
An Economical Tri-tet Crystal Oscillator (Horton).....	40, June
Emergency Grid Tank (Exp. Section).....	71, Jan.
A Frequency-Checking Superhet (Griffin).....	38, Apr.
New Method of Lowering Crystal Frequency (Exp. Section).....	64, Apr.
One Crystal — Two Tubes — Five Bands (Ferrill).....	42, Mar.
An Oscillator Which Combines Many Features (Exp. Section).....	69, Jan.
Three-way Crystal Socket (Exp. Section).....	51, June

**TRANSMITTERS — PORTABLE AND LOW POWER**

(See also, "Safety Technique")

Building Reliability into the Portable Rig (Thomas).....	34, May
The "Economy Forty" (Sutter).....	18, Apr.
A Hurricane Emergency Transmitter and Power Supply (Smith).....	18, July
Kinks for Portable Transmitters (Exp. Section).....	50, Aug.
One-Half Cubic Foot of Transmitter (Rice).....	20, Jan.
The Portable at W7AW (Iversen).....	54, Nov.
Portable-Emergency Transmitters (Symposium of five designs).....	22, Aug.
A Portable-Emergency Utility Transmitter (Leuck).....	30, Sept.
The "Portable Five" (Sutter).....	32, Dec.
A Portable Station for A.C. or Battery Operation (Steiner).....	34, Mar.
The "Runt Sixty" and "QSL Sixty" (Sutter).....	50, Sept.

**TRANSMITTERS — MEDIUM AND HIGH POWER**

(See also, "Safety Technique")

A Compact and Economical 500-Watt All-Band Transmitter (Jones).....	38, May
A Compact Unit-Type Amplifier (Shuart).....	38, Oct.

A Compact 1/4-KW Rig (Mix).....	9, Oct.
"Dish-Type" Construction for the High-Power Amplifier (Mix).....	26, Dec.
An Economical Six-Band Transmitter (Roberts).....	50, Feb.
A Miniature 100-Watt Amplifier (Millen).....	38, Mar.
New Ideas for Transmitters (Ferrill).....	34, Sept.
Revamping the 30FXB for 28 and 56 Mc. (Keim).....	46, Dec.
A Rig for the Lean Purse (Dominguez).....	28, May
A Safety Kilowatt Transmitter (Bishop).....	42, Nov.

**TUBES**

New Acorn Tubes.....	18, Feb.
New Method of Rating Transmitting Tubes.....	48, Nov.
New Tubes ("Bantam" types; single-end types; 1G4G, 1G6G; 1620-1-2; A.C.-D.C. Mobile types).....	25, Apr.
HK24, 810.....	19, Jan.
TW 150.....	62, Oct.
75T.....	49, Aug.
828.....	29, Nov.

**ULTRA-HIGH FREQUENCIES — APPARATUS**

The Coaxial Vertical Radiator (Long).....	42, Jan.
A Compact, Crystal-Controlled 56-28-Mc. 'Phone Transmitter (Kahle).....	55, Jan.
A Compact "Five and Ten" Converter for Mobile Use (Chapman).....	11, June
Exploring Below One Meter (Tynes and Babcock).....	16, May
High-Q Tank Circuit for Ultra-High Frequencies (Peterson).....	19, Sept.
Modernizing the 56-Mc. Receiver (Wagenseller).....	38, Feb.
The Rig at W8XA1 (Long).....	42, June
A Simple 5-, 10- and 20-Meter Converter for Home or Car (Chapin).....	44, May
Simplicity on 112-Mc. (Griffith).....	38, July
A Stable and Inexpensive 56-Mc. Transmitter (Mix).....	25, June
A Superhet Converter for 5- and 10-Meter Reception (Lester).....	30, Apr.
A 112-Mc. Pack Set (Chambers).....	32, June
A 15-Watt Crystal-Controlled Five-Meter 'Phone (Pickett).....	48, Mar.
"5 and 10" From Shack or Car (Taylor).....	34, Aug.

**ULTRA-HIGH FREQUENCIES — TESTS**

Announcing — U.H.F. Field Day and Relay.....	33, Sept.
Colorado Hams Make 112-Mc. History.....	74, Nov.
DX on 56-Mc. Continues Through July.....	58, Sept.
"On the Ultra-Highs" (Tilton).....	29, Dec.
Progress on 225 Megacycles at Mount Washington (Bent).....	62, Sept.
U.H.F. Activity at Summertime Peak.....	42, Aug.
U.H.F. Contest and Relay — November 4th-5th.....	53, Nov.
The U.H.F. Relay (Handy).....	26, Nov.
56 and 112 Mcs.....	78, May
56-Mc. Open for DX.....	52, July
56-Mc. Tests.....	22, May

**WHAT THE LEAGUE IS DOING**

18, Jan.; 19, Feb.; 33, Mar.; 24, Apr.; 23, May; 19, June; 27, July; 30, Aug.; 28, Sept.; 22, Oct.; 22, Nov.; 24, Dec.	
Circulation Statement.....	98, June; 98, Dec.
Election Notices, Directors.....	28, Sept.; 22, Oct.
Election Results, Directors.....	19, Feb.; 24, Dec.
Election Statistics.....	96, Mar.
Executive Committee Minutes.....	30, Aug.
Financial Statement.....	19, Jan.; 25, Apr.; 90, July; 23, Oct.; 25, Dec.
Membership Contact.....	22, Nov.
Membership Growth.....	24, Dec.
Questionnaire Data.....	30, Aug.
Should 7200-7300 Be Opened to 'Phone?.....	32a, July
Some Staff Changes.....	33, Mar.
1939 Board Agenda.....	23, May
1939 Board Meets.....	19, June
1939 Board Minutes.....	27, July
7-Mc. Poll Results.....	22, Nov.

**WITH THE AFFILIATED CLUBS**

32, Jan.; 41, Mar.	
Affiliated Club Honor Roll.....	102, May

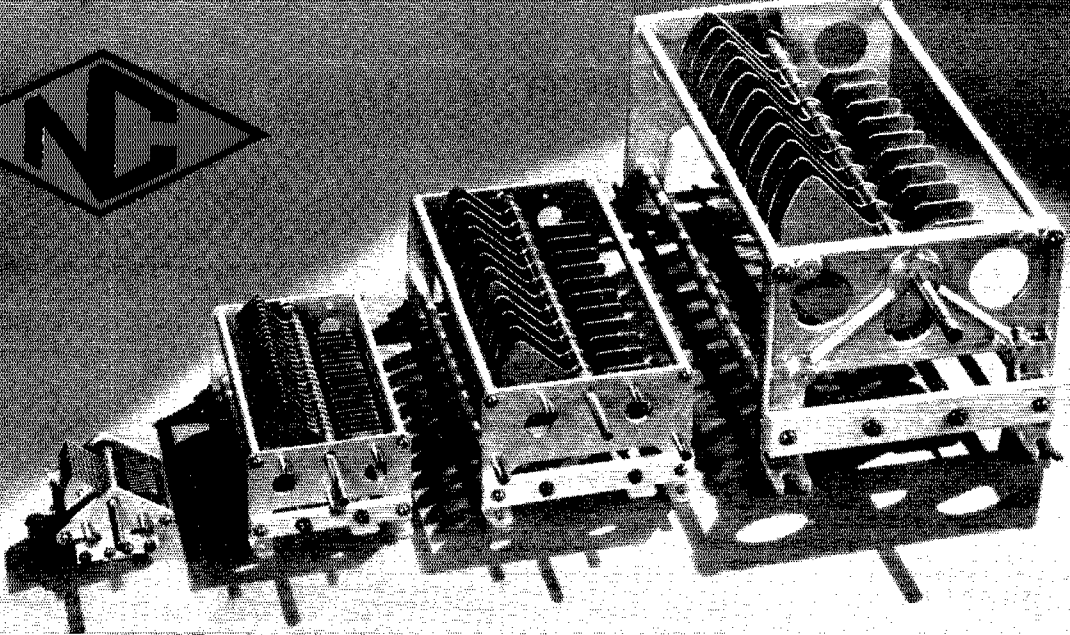
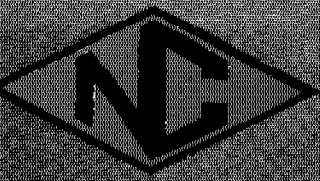

# NATIONAL CONDENSERS for FINE TRANSMITTERS

These are the condensers which you see so often in illustrations of high performance gear, and hear so much about in articles on advanced transmitter designs. They have an impressive record for efficient, dependable operation, for conservative rating, for ability to stand punishment. Everything about them is right, even the price. For example, the big TML with cast aluminum end frames sells for only \$9.90 net in the 50 mmf, 15,000 volt size. National Company, Inc., Malden, Mass.

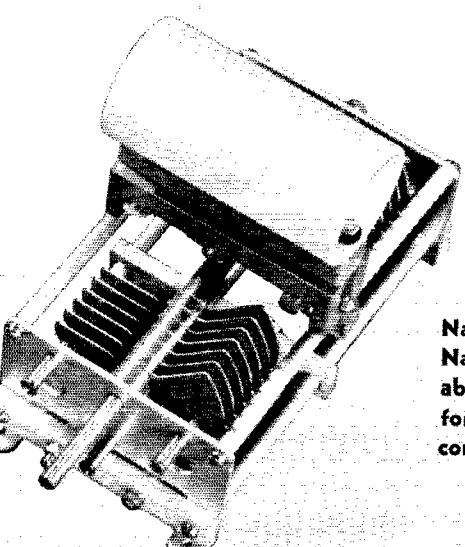

## NATIONAL COILS for PERFECT TEAMWORK

National Coil Forms and Coils are designed to work with National Condensers. Special plug-in mounts are available for assembly on the condenser tie-bars. Use them for short leads, for low losses, for compactness and for convenience.

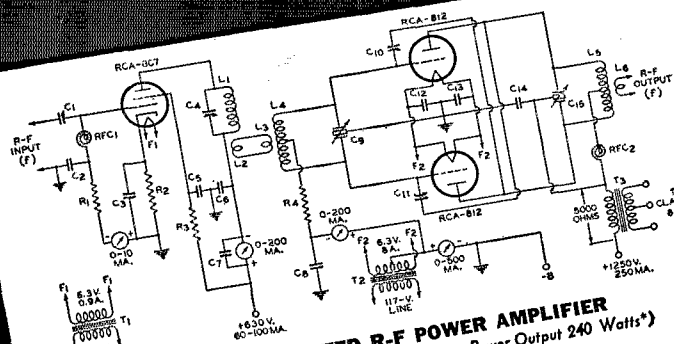

### PLATE-MODULATED R-F POWER AMPLIFIER (Class C Telephony Power Output 240 Watts\*)

With Beam Power Driver Stage

- $C_1 = 10\text{-}70$  mmfd. mica trimmer
- $C_2, C_3, C_4, C_5, C_6, C_7, C_8, C_{12}, C_{13} = 0.005$  mfd. mica
- $C_9 = 165$  mmfd.,  $0.05''$  air-gap
- $C_{10} = 260$  mmfd./section,  $0.031''$  air-gap
- $C_{11} = 4\text{-}7$  mmfd.,  $0.140''$  air-gap
- $C_{14} = 0.002$  mfd.,  $5000$  volts
- $C_{15} = 100$  mmfd./section,  $0.07''$  air-gap #
- $R_1 = 10000$  ohms,  $1$  watt
- $R_2 = 300$  ohms,  $5$  watts
- $R_3 = 40000$  ohms,  $10$  watts
- $R_4 = 25000$  ohms,  $10$  watts
- RFC1, RFC2 =  $2\frac{1}{2}$  mb. r-f choke, small size
- $L_1, L_4, L_5 =$  Tune to frequency
- $L_2, L_3, L_6 =$  2-tum coupling links
- $T_1, T_2 =$  Filament transformer,  $150$  watts
- $T_3 =$  Modulation transformer,  $150$  watts

\*Approximate. #Adjust  $C_{15}$  to about  $1.2$  mmfd./meter/section, or full-in on  $160$  meters.  
NOTE: Rotor shaft of  $C_{15}$  is at the high d-c plate potential. An insulated coupling shaft must be inserted between the rotor shaft of  $C_{15}$  and its control dial.

Here you are—an 807/push-pull 812/class B 811 combination that illustrates something of the amazing possibilities of the new RCA-811's and RCA-812's with their exclusive zirconium-coated anodes and low-loss Micanol bases! This may not be the last word in amateur rigs, but for a cw power input of 450 watts or a phone input of 310 watts, it is mighty difficult to beat. Tube cost figures and over-all performance speak for themselves!

The general transmitter layout illustrated is recommended for 10, 20, 40, 80 and 160 meter operation. Commercial plug-in coils may be used if desired, but  $C_{15}$  will ordinarily require a larger capacitance to hit resonance on 80 and 160 meters.

Chassis illustrated is designed for either "table-top" or rack-and-panel

mounting. It measures  $10'' \times 17'' \times 3''$ . The two 6.3 volt filament transformers, various by-pass condensers and resistors are mounted underneath. A separate filament transformer for the 812's permits center-tap keying for cw operation. Push-pull 811's may be used in the same circuit by changing grid leak  $R_4$  to 1250 ohms (20 watts).

Additional applications showing the outstanding results obtainable with the record-breaking new RCA-811's and RCA-812's are given in 'Ham Tips' for October, 1939. Copies are free from RCA distributors or from the Commercial Engineering Section, RCA Mfg. Co., Inc., Harrison, New Jersey.

## The Big 3..

### RCA-807

Beam Power Tetrode  
Plate voltage, 750 V.  
Plate input, 75 W.  
Plate dissipation, 30 W.  
Amateur Net \$3.50

### RCA-811

High-Mu Triode  
Plate voltage, 250 V.  
Plate input, 125 W.  
Plate dissipation, 55 W.  
Amateur Net \$3.50 each

### RCA-812

Medium Mu Triode  
Plate voltage, 250 V.  
Plate input, 125 W.  
Plate dissipation, 55 W.  
Amateur Net \$3.50 each

Above ratings are the new RCA ICAS Ratings—(Intermittent Commercial and Amateur Service). They are well suited for many intermittent services which demand low initial cost and maximum power output. CCS (Continuous Commercial Service) Ratings remain the same as the old maximum RCA Ratings. Write for Bulletin.



RCA MANUFACTURING  
CO., INC. CAMDEN, N. J.

A Service of the Radio  
Corporation of America

# Radio Tubes

FIRST IN METAL—FOREMOST IN GLASS—FINEST IN PERFORMANCE

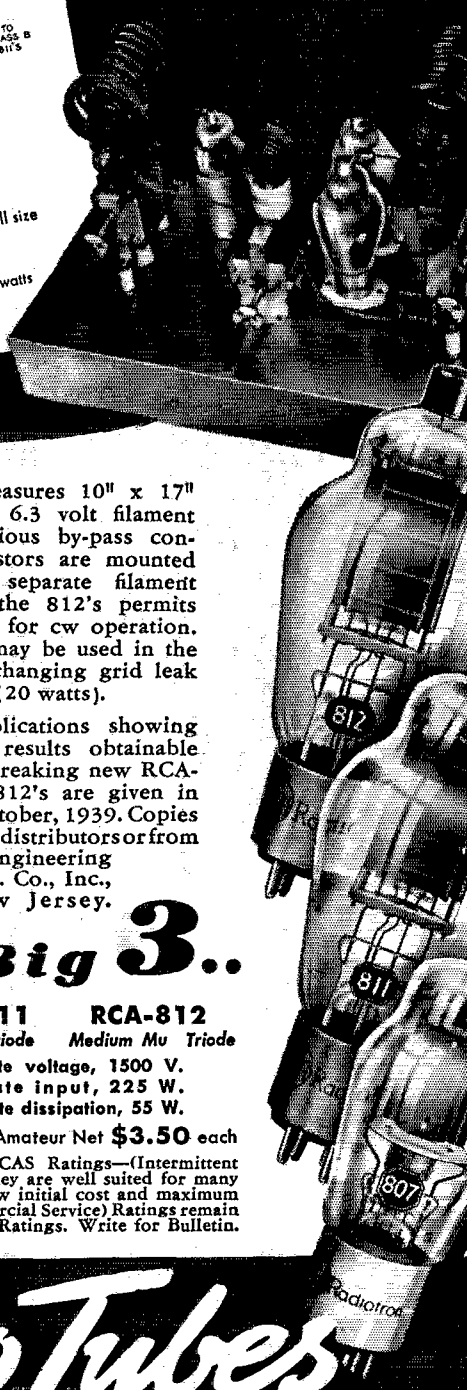



Merry Christmas

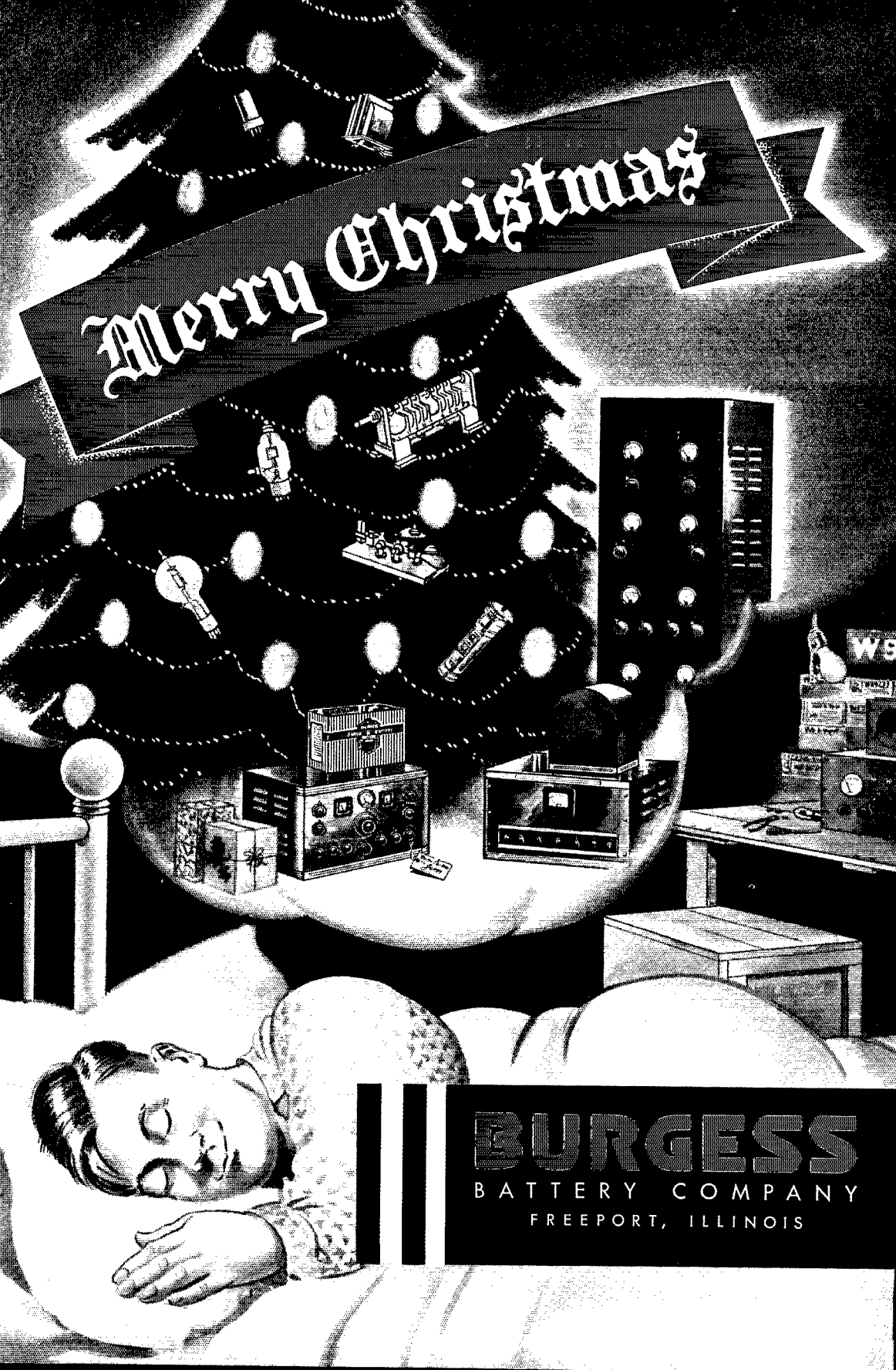

**BURGESS**

BATTERY COMPANY

FREEPORT, ILLINOIS

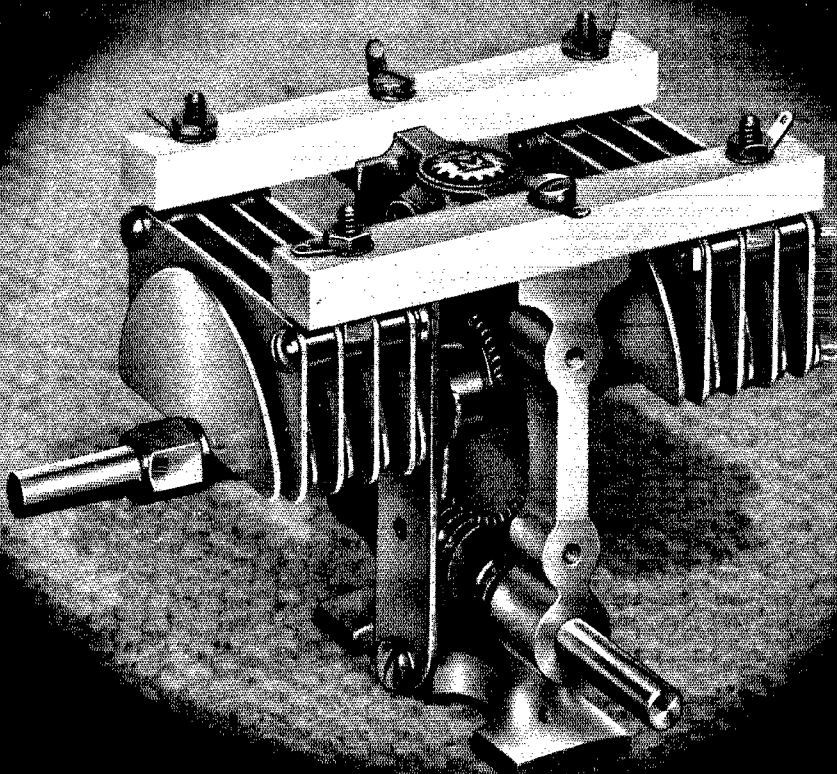

# DESIGNED for APPLICATION

The new No. 13000 series of variable transmitting condensers permit a compact symmetrical efficient layout of the circuit, chassis, and front panel. No "shorted-turn" frame loops. Centre feed, self locking right angle rotor drive. Genuine ISOLANTITE dielectric. A modern condenser for use with modern tubes, at a price within the Amateur's reach!

At the right are typical applications of other new MILLEN products: The No. 37001 high voltage safety terminal, the No. 37105 AC control terminal block, the No. 37222 steatite link line terminal plate and posts, the No. 15001 QuartzQ neutralizing condensers, the No. 32100 steatite thru bushings, the No. 70225 plug-in grid-tank circuit, the No. 34100 RF choke, the steatite sockets, and the "meter-type" drum indicator dial.

*See These New Items at Your Dealer's Today*

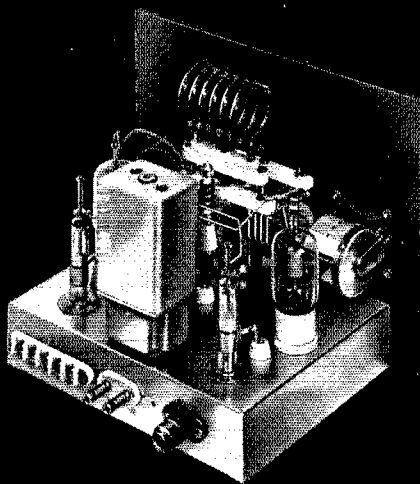

**JAMES MILLEN**  
50 EXCHANGE ST.



**MFG. CO. INC.**  
MALDEN, MASS.

# More for Your Money!

MORE FEATURES THAN CAN BE DESCRIBED ON THIS PAGE

## See Them — Test Them!

Imagine non-inductive resistors with zero inductance at 50 mc. and distributed capacity of only 2 mmfd. available at the lowest prices ever!

Imagine 70,000 ohms of wire wound resistance in ten watt size actually dissipating ten full watts! . . .

Sprague Koolohms are the only truly insulated power wire wound resistors on the market. Every bit of wire is coated before winding with an amazing new heat-proof, moisture-proof insulating material. This permits interleaved layer windings with larger, stronger wire sizes — in less space than is required for the fragile fine wire of ordinary resistors. No "swimming" of turns. No shorted turns. Koolohms keep a constant resistance value under full load indefinitely. No cements or brittle enamels. Mount Koolohms in direct contact with any metal parts without danger of shorts. Resistance values on standard resistors are guaranteed within 5% accuracy.

Your jobber now has Koolohms in 5-watt fixed types; 10-watt fixed; 10-watt non-inductive and 10-watt adjustable. The greatest buys on the market! Catalog free.

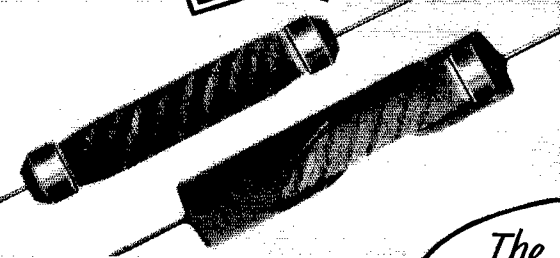
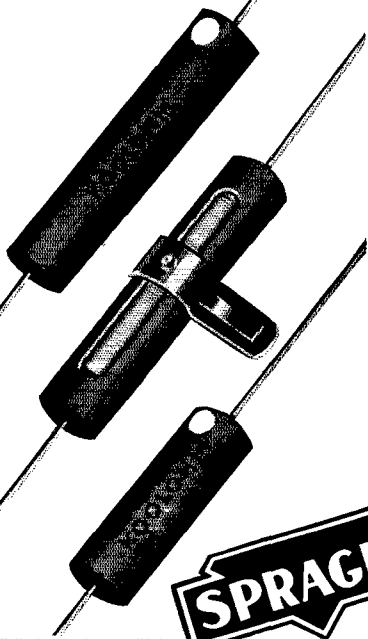

### WIRES TOUCH — BUT THEY DON'T SHORT!

Note the unique, interleaved winding pattern of Koolohms made possible by perfect insulation of the wire itself. This means higher resistances in a given space, larger diameter wire for greater protection in the high values, greater accuracy and an amazing reduction in inductance. Note also, in the cut-away picture, how Koolohms are protected mechanically by a dark brown outer ceramic shell. No danger of chipping or breakage.

### NEW ENUF — GOOD ENUF to be featured editorially in QST

Don't take our word for the outstanding quality of Koolohms! Turn to Page 52 of QST for August 1939. Read the result of impartial tests. Get the facts as seen by an "outside" technician who terms them "An innovation in resistor construction."

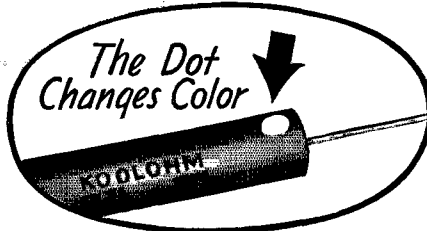

### FULL WATTAGE RATING for ALL VALUES — TELEDOT WATTAGE INDICATOR

The red dot on the end of each Koolohm is a "Teledot" overload indicator. This dot automatically changes color when a 25% overload occurs — tells when you are operating safely — warns when operating at dangerous overload. Yet Koolohms take overloads better than any other resistors. You just can't break them down.

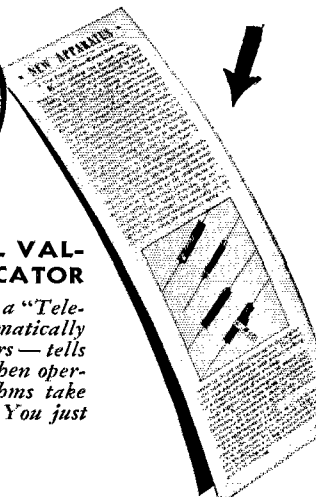

———— SPRAGUE WIRE SIZE      ————— WIRE SIZE OTHER RESISTORS

# SPRAGUE KOOLOHMS

The Biggest Wire Wound Resistor Improvement in 20 Years

. . . By the Makers of Famous Sprague Condensers . . .

SPRAGUE PRODUCTS COMPANY, North Adams, Mass.